

**PLEASE CHECK WWW.MOLEX.COM FOR LATEST PART INFORMATION**

**Part Number:** [0532530270](#)  
**Status:** **Active**  
**Overview:** Micro-Latch™ Wire-to-Board Connector System  
**Description:** 2.00mm Pitch Micro-Latch™ Wire-to-Board Header, Vertical, Square Pin, Three-sided Shroud, 2 Circuits

**Documents:**

[3D Model](#) [Packaging Specification SPK-53253-001-001 \(PDF\)](#)  
[Drawing \(PDF\)](#) [RoHS Certificate of Compliance \(PDF\)](#)  
[Product Specification PS-51065-016-001 \(PDF\)](#)

**General**

Product Family	PCB Headers
Series	<a href="#">53253</a>
Application	Signal, Wire-to-Board
MolexKits	Yes
Overview	<u>Micro-Latch™ Wire-to-Board Connector System</u>
Product Name	Micro-Latch™
UPC	756054354001

**Physical**

Breakaway	No
Circuits (Loaded)	2
Circuits (maximum)	2
Durability (mating cycles max)	30
First Mate / Last Break	No
Glow-Wire Compliant	No
Lock to Mating Part	Yes
Material - Metal	Brass
Material - Plating Mating	Tin
Material - Plating Termination	Tin
Material - Resin	Nylon
Net Weight	89.700/mg
Number of Rows	1
Orientation	Vertical
PC Tail Length	3.50mm
PCB Locator	No
PCB Retention	Yes
PCB Thickness - Recommended	1.60mm
Packaging Type	Tray
Pitch - Mating Interface	2.00mm
Plating min - Mating	1.016µm
Plating min - Termination	1.016µm
Polarized to Mating Part	Yes
Polarized to PCB	No
Shrouded	Partial
Stackable	No
Surface Mount Compatible (SMC)	No
Temperature Range - Operating	-40°C to +105°C
Termination Interface: Style	Through Hole

**Electrical**

Current - Maximum per Contact	2.0A
Voltage - Maximum	125V

**Material Info**

**Reference - Drawing Numbers**

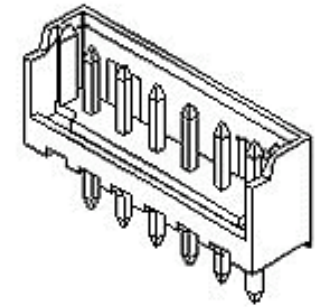

*Series image - Reference only*

**EU ELV**

**Not Relevant**

**EU RoHS**

**Compliant**

**REACH SVHC**

Not Contained Per -  
ED/21/2016 (20 June  
2016)

**Halogen-Free**

**Status**

**Not Low-Halogen**

**Need more information on product environmental compliance?**

Email [productcompliance@molex.com](mailto:productcompliance@molex.com)  
Please visit the [Contact Us](#) section for any non-product compliance questions.

China ROHS	Green Image
ELV	Not Relevant
RoHS Phthalates	Not Contained

**Search Parts in this Series**

[53253](#) Series

**Mates With**

[51065](#) Crimp Housing, [50212](#) Crimp Terminal

Packaging Specification  
Product Specification  
Sales Drawing

SPK-53253-001-001  
PS-51065-016-001  
SD-51065-006, SD-53253-001

This document was generated on 11/03/2016

**PLEASE CHECK [WWW.MOLEX.COM](http://WWW.MOLEX.COM) FOR LATEST PART INFORMATION**