

**FEATURES**

**Fixed gain of 24.1 dB**  
**Broadband operation from 30 MHz to 6 GHz**  
**Input/output internally matched to 50  $\Omega$**   
**Integrated bias control circuit**  
**OIP3 of 36.4 dBm at 900 MHz**  
**P1dB of 18.1 dBm at 900 MHz**  
**Noise figure of 2.9 dB at 900 MHz**  
**Single 5 V power supply**  
**Low quiescent current of 56 mA**  
**Wide operating temperature range of  $-40^{\circ}\text{C}$  to  $+105^{\circ}\text{C}$**   
**Thermally efficient SOT-89 package**  
**ESD rating of  $\pm 1.5$  kV (Class 1C)**

**GENERAL DESCRIPTION**

The [ADL5545](#) is a single-ended RF/IF gain block amplifier that provides broadband operation from 30 MHz to 6 GHz. The [ADL5545](#) provides over 36 dBm of OIP3 using only 56 mA from a 5 V supply.

The [ADL5545](#) provides a gain of 24 dB, which is stable over frequency, temperature, power supply, and from device to device. The amplifier is offered in the industry-standard SOT-89 package and is internally matched to 50  $\Omega$  at the input and output, making the [ADL5545](#) very easy to implement in a wide variety of applications. The only external components required are the input/output ac coupling capacitors, power supply decoupling capacitors, and dc bias inductor.

**FUNCTIONAL BLOCK DIAGRAM**

Figure 1.

The [ADL5545](#) is fabricated on an InGaP HBT process and has a high ESD rating of  $\pm 1.5$  kV (Class 1C). The [ADL5545](#) is also fully specified for operation across the wide temperature range of  $-40^{\circ}\text{C}$  to  $+105^{\circ}\text{C}$ . A fully populated RoHS-compliant evaluation board is available.

# ADL5545\* Product Page Quick Links

Last Content Update: 11/01/2016

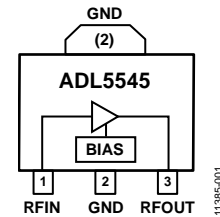
---

## [Comparable Parts](#)

View a parametric search of comparable parts

## [Evaluation Kits](#)

- ADL5545 Evaluation Board

## [Documentation](#)

### **Application Notes**

- AN-1363: Meeting Biasing Requirements of Externally Biased RF/Microwave Amplifiers with Active Bias Controllers

### **Data Sheet**

- ADL5545: 30 MHz to 6 GHz RF/IF Gain Block Data Sheet

## [Tools and Simulations](#)

- ADI RF Amplifier Library for Agilent ADS
- ADIsimRF
- ADL5545 S-Parameters

## [Reference Materials](#)

### **Press**

- Analog Devices Unveils New Industry-Leading Broadband RF Gain Blocks

### **Product Selection Guide**

- RF Source Booklet

## [Design Resources](#)

- ADL5545 Material Declaration
- PCN-PDN Information
- Quality And Reliability
- Symbols and Footprints

## [Discussions](#)

View all ADL5545 EngineerZone Discussions

## [Sample and Buy](#)

Visit the product page to see pricing options

## [Technical Support](#)

Submit a technical question or find your regional support number

---

## TABLE OF CONTENTS

Features .....	1	100 MHz to 500 MHz Frequency Band .....	10
Functional Block Diagram .....	1	4 GHz to 6 GHz Frequency Band .....	11
General Description .....	1	General.....	12
Revision History .....	2	Applications Information .....	14
Specifications.....	3	Basic Connections.....	14
Typical Scattering Parameters (S-Parameters) .....	5	Soldering Information and Recommended	
Absolute Maximum Ratings.....	7	PCB Land Pattern.....	15
Thermal Resistance .....	7	Operation Down to 30 MHz.....	16
ESD Caution.....	7	W-CDMA ACPR Performance .....	16
Pin Configuration and Function Descriptions.....	8	Evaluation Board .....	17
Typical Performance Characteristics .....	9	Outline Dimensions .....	18
500 MHz to 4 GHz Frequency Band.....	9	Ordering Guide .....	18

## REVISION HISTORY

### 11/13—Rev. 0 to Rev. A

Added Figure 25, Renumbered Sequentially .....	12
Changes to Figure 34.....	15
Updated Outline Dimensions .....	18

### 4/13—Revision 0: Initial Version

## SPECIFICATIONS

$V_{POS} = 5\text{ V}$  and  $T_A = 25^\circ\text{C}$ , unless otherwise noted.

Table 1.

Parameter	Test Conditions/Comments	Min	Typ	Max	Unit
OVERALL FUNCTION					
Frequency Range		30		6000	MHz
FREQUENCY = 30 MHz					
Gain			22.6		dB
Output 1 dB Compression Point			12.0		dBm
Output Third-Order Intercept	$\Delta f = 1\text{ MHz}$ , output power ( $P_{OUT}$ ) = $-3\text{ dBm}$ per tone		30.3		dBm
Noise Figure			3.8		dB
FREQUENCY = 140 MHz					
Gain			24.8		dB
vs. Frequency	$\pm 10\text{ MHz}$		$\pm 0.03$		dB
vs. Temperature	$-40^\circ\text{C} \leq T_A \leq +85^\circ\text{C}$		$\pm 0.6$		dB
vs. Supply	4.75 V to 5.25 V		$\pm 0.30$		dB
Output 1 dB Compression Point			14.6		dBm
Output Third-Order Intercept	$\Delta f = 1\text{ MHz}$ , output power ( $P_{OUT}$ ) = $-3\text{ dBm}$ per tone		31.5		dBm
Noise Figure			3.1		dB
FREQUENCY = 350 MHz					
Gain			24.6		dB
vs. Frequency	$\pm 10\text{ MHz}$		$\pm 0.01$		dB
vs. Temperature	$-40^\circ\text{C} \leq T_A \leq +85^\circ\text{C}$		$\pm 0.6$		dB
vs. Supply	4.75 V to 5.25 V		$\pm 0.30$		dB
Output 1 dB Compression Point			16.1		dBm
Output Third-Order Intercept	$\Delta f = 1\text{ MHz}$ , output power ( $P_{OUT}$ ) = $-3\text{ dBm}$ per tone		32.6		dBm
Noise Figure			3.3		dB
FREQUENCY = 700 MHz					
Gain		23.7	24.4	25.1	dB
vs. Frequency	$\pm 50\text{ MHz}$		$\pm 0.05$		dB
vs. Temperature	$-40^\circ\text{C} \leq T_A \leq +85^\circ\text{C}$		$\pm 0.5$		dB
vs. Supply	4.75 V to 5.25 V		$\pm 0.13$		dB
Output 1 dB Compression Point			17.9		dBm
Output Third-Order Intercept	$\Delta f = 1\text{ MHz}$ , output power ( $P_{OUT}$ ) = $-3\text{ dBm}$ per tone		38.8		dBm
Noise Figure			3.0		dB
FREQUENCY = 900 MHz					
Gain		23.4	24.1	24.8	dB
vs. Frequency	$\pm 50\text{ MHz}$		$\pm 0.07$		dB
vs. Temperature	$-40^\circ\text{C} \leq T_A \leq +85^\circ\text{C}$		$\pm 0.5$		dB
vs. Supply	4.75 V to 5.25 V		$\pm 0.13$		dB
Output 1 dB Compression Point			18.1		dBm
Output Third-Order Intercept	$\Delta f = 1\text{ MHz}$ , output power ( $P_{OUT}$ ) = $-3\text{ dBm}$ per tone		36.4		dBm
Noise Figure			2.9		dB
FREQUENCY = 1900 MHz					
Gain		21.5	22.2	22.9	dB
vs. Frequency	$\pm 50\text{ MHz}$		$\pm 0.11$		dB
vs. Temperature	$-40^\circ\text{C} \leq T_A \leq +85^\circ\text{C}$		$\pm 0.7$		dB
vs. Supply	4.75 V to 5.25 V		$\pm 0.17$		dB
Output 1 dB Compression Point			16.6		dBm
Output Third-Order Intercept	$\Delta f = 1\text{ MHz}$ , output power ( $P_{OUT}$ ) = $-3\text{ dBm}$ per tone		35.2		dBm
Noise Figure			3.4		dB

Parameter	Test Conditions/Comments	Min	Typ	Max	Unit
FREQUENCY = 2140 MHz					
Gain		21.1	21.8	22.4	dB
vs. Frequency	±50 MHz		±0.09		dB
vs. Temperature	−40°C ≤ T <sub>A</sub> ≤ +85°C		±0.7		dB
vs. Supply	4.75 V to 5.25 V		±0.17		dB
Output 1 dB Compression Point			16.2		dBm
Output Third-Order Intercept	Δf = 1 MHz, output power (P <sub>OUT</sub> ) = −3 dBm per tone		35.7		dBm
Noise Figure			3.5		dB
FREQUENCY = 2600 MHz					
Gain		20.1	20.9	21.7	dB
vs. Frequency	±50 MHz		±0.09		dB
vs. Temperature	−40°C ≤ T <sub>A</sub> ≤ +85°C		±0.7		dB
vs. Supply	4.75 V to 5.25 V		±0.16		dB
Output 1 dB Compression Point			15.7		dBm
Output Third-Order Intercept	Δf = 1 MHz, output power (P <sub>OUT</sub> ) = −3 dBm per tone		34.6		dBm
Noise Figure			3.6		dB
FREQUENCY = 3500 MHz					
Gain		19.0	19.7	20.4	dB
vs. Frequency	±50 MHz		±0.10		dB
vs. Temperature	−40°C ≤ T <sub>A</sub> ≤ +85°C		±0.8		dB
vs. Supply	4.75 V to 5.25 V		±0.17		dB
Output 1 dB Compression Point			14.5		dBm
Output Third-Order Intercept	Δf = 1 MHz, output power (P <sub>OUT</sub> ) = −3 dBm per tone		33.7		dBm
Noise Figure			4.0		dB
FREQUENCY = 4000 MHz					
Gain		17.8	18.6	19.4	dB
vs. Frequency	±50 MHz		±0.14		dB
vs. Temperature	−40°C ≤ T <sub>A</sub> ≤ +85°C		±1.0		dB
vs. Supply	4.75 V to 5.25 V		±0.19		dB
Output 1 dB Compression Point			13.1		dBm
Output Third-Order Intercept	Δf = 1 MHz, output power (P <sub>OUT</sub> ) = −3 dBm per tone		29.0		dBm
Noise Figure			4.6		dB
FREQUENCY = 5000 MHz					
Gain			16.8		dB
vs. Frequency	±50 MHz		±0.05		dB
vs. Temperature	−40°C ≤ T <sub>A</sub> ≤ +85°C		±1.2		dB
vs. Supply	4.75 V to 5.25 V		±0.20		dB
Output 1 dB Compression Point			9.9		dBm
Output Third-Order Intercept	Δf = 1 MHz, output power (P <sub>OUT</sub> ) = −3 dBm per tone		31.8		dBm
Noise Figure			4.8		dB
FREQUENCY = 5800 MHz					
Gain			15.9		dB
vs. Frequency	±50 MHz		±0.20		dB
vs. Temperature	−40°C ≤ T <sub>A</sub> ≤ +85°C		±1.3		dB
vs. Supply	4.75 V to 5.25 V		±0.20		dB
Output 1 dB Compression Point			9.4		dBm
Output Third-Order Intercept	Δf = 1 MHz, output power (P <sub>OUT</sub> ) = −3 dBm per tone		28.4		dBm
Noise Figure			5.2		dB
POWER INTERFACE					
Supply Voltage	V <sub>POS</sub>	4.75	5	5.25	V
Supply Current			56	70	mA
vs. Temperature	−40°C ≤ T <sub>A</sub> ≤ +85°C		−6		mA
Power Dissipation	V <sub>POS</sub> = 5 V		280		mW

**TYPICAL SCATTERING PARAMETERS (S-PARAMETERS)**

$V_{POS} = 5\text{ V}$  and  $T_A = 25^\circ\text{C}$ . The effects of the test fixture have been deembedded up to the pins of the device.

Table 2.

Frequency (MHz)	S11		S21		S12		S22	
	Magnitude (dB)	Angle (°)	Magnitude (dB)	Angle (°)	Magnitude (dB)	Angle (°)	Magnitude (dB)	Angle (°)
30	0.262848	-47.6295	14.45259	177.5351	0.045367	11.15995	0.133274	-102.531
50	0.16114	-55.2231	15.15086	175.6394	0.045744	5.819622	0.089972	-123.652
100	0.093068	-77.639	15.78907	173.6613	0.045475	0.757324	0.064358	-143.775
200	0.068146	-108.37	16.02686	168.5803	0.044902	-3.04168	0.054958	-149.301
300	0.072583	-127.99	16.07148	163.4185	0.044363	-5.34172	0.061241	-149.444
400	0.077593	-139.813	15.98431	157.8149	0.043939	-7.0452	0.068816	-152.411
500	0.090466	-156.112	16.05625	152.0089	0.043468	-8.71529	0.078388	-156.801
600	0.088983	-163.801	15.87255	146.3219	0.043343	-9.99294	0.082927	-161.395
700	0.092819	-165.254	15.53395	140.6962	0.043126	-11.4604	0.091705	-165.732
800	0.095784	-171.948	15.36561	135.1523	0.043134	-12.7678	0.095819	-170.208
900	0.102604	-179.011	15.24074	129.5742	0.042992	-14.1595	0.105012	-174.57
1000	0.09546	-179.149	14.88376	124.1535	0.043208	-15.412	0.10382	-176.858
1100	0.103295	174.7787	14.70169	118.6387	0.043095	-16.7459	0.111433	178.3385
1200	0.093216	179.0039	14.34868	113.3993	0.043512	-18.1192	0.109622	178.9569
1300	0.098569	176.2059	14.27985	108.0531	0.043553	-19.5857	0.11369	175.9297
1400	0.102425	179.6522	14.03556	102.9911	0.043723	-21.2064	0.11632	175.6884
1500	0.101141	-178.753	13.78558	97.78215	0.04388	-22.6683	0.116498	174.9498
1600	0.104256	-174.192	13.71874	92.56152	0.044204	-24.4303	0.117977	174.9185
1700	0.107955	-170.745	13.57927	87.51542	0.044342	-25.9244	0.117231	175.8795
1800	0.116255	-160.02	13.29429	82.68712	0.044789	-27.8402	0.119281	-179.561
1900	0.120964	-156.118	13.17331	77.73154	0.045028	-29.4276	0.119431	-177.054
2000	0.134422	-148.939	12.91149	72.88006	0.045414	-31.4216	0.122578	-171.248
2100	0.144804	-145.439	12.80398	67.92418	0.045764	-33.3004	0.125497	-165.568
2200	0.152409	-141.698	12.59211	63.00376	0.046097	-35.0534	0.127437	-159.324
2300	0.172904	-137.298	12.25861	58.39029	0.046511	-37.1505	0.133391	-152.405
2400	0.182797	-136.054	12.16048	53.61962	0.046875	-39.1307	0.138487	-146.315
2500	0.194182	-134.876	11.93425	48.88951	0.047094	-41.1358	0.142416	-141.232
2600	0.214678	-133.689	11.59419	44.30914	0.04742	-43.3517	0.149636	-137.023
2700	0.224862	-133.954	11.45006	39.79969	0.04771	-45.3525	0.152783	-133.92
2800	0.237618	-134.459	11.20878	35.26209	0.047939	-47.5024	0.156654	-132.6
2900	0.254998	-135.366	10.94307	30.79007	0.048142	-49.8763	0.161272	-133.403
3000	0.259741	-136.415	10.818	26.20347	0.048485	-51.8757	0.163889	-134.121
3100	0.268457	-138.409	10.55454	21.74989	0.048594	-54.1577	0.167361	-137.318
3200	0.279771	-140.41	10.33472	17.30951	0.048847	-56.5108	0.17422	-140.652
3300	0.280296	-142.8	10.20153	12.84427	0.049022	-58.6503	0.180631	-143.308
3400	0.289458	-145.933	10.00319	8.513198	0.049204	-61.003	0.191885	-147.598
3500	0.295282	-149.389	9.830752	4.094389	0.0494	-63.3968	0.201435	-151.432
3600	0.299935	-152.81	9.708636	-0.51683	0.049578	-65.7102	0.210887	-154.16
3700	0.308557	-156.47	9.552554	-4.89998	0.049752	-68.2673	0.220513	-157.585
3800	0.322587	-159.819	9.356577	-9.27746	0.049957	-70.7703	0.230421	-160.673
3900	0.331813	-163.085	9.236345	-13.8743	0.050078	-73.2644	0.239419	-163.74
4000	0.349624	-166.445	9.030995	-18.073	0.050214	-75.9969	0.250879	-167.215
4100	0.364557	-169.126	8.880835	-22.5061	0.050314	-78.5494	0.263277	-170.404
4200	0.373416	-172.227	8.75356	-26.9943	0.050299	-81.1499	0.277221	-173.285
4300	0.387883	-175.007	8.52107	-31.2568	0.050336	-83.8987	0.293719	-175.814
4400	0.393838	-177.914	8.396822	-35.6516	0.050379	-86.5744	0.310153	-177.48
4500	0.397031	178.8178	8.269613	-39.9908	0.050311	-89.3666	0.326031	-178.445

Frequency (MHz)	S11		S21		S12		S22	
	Magnitude (dB)	Angle (°)	Magnitude (dB)	Angle (°)	Magnitude (dB)	Angle (°)	Magnitude (dB)	Angle (°)
4600	0.403438	175.5599	8.049058	-44.1889	0.050324	-92.3473	0.340214	-178.955
4700	0.401499	171.8158	7.964614	-48.7045	0.050239	-95.0828	0.350676	-178.928
4800	0.402691	167.514	7.806924	-53.0729	0.050117	-98.0907	0.356655	-179.069
4900	0.406951	163.0433	7.595136	-57.4387	0.049987	-101.172	0.357806	-179.375
5000	0.406358	157.9584	7.49582	-61.8963	0.049721	-103.942	0.354643	-179.768
5100	0.411878	152.676	7.317407	-66.1646	0.049487	-107.027	0.348613	178.5262
5200	0.419117	147.3732	7.122278	-70.4926	0.049173	-110.061	0.341386	175.9255
5300	0.424908	141.8343	6.989999	-74.8425	0.048744	-112.912	0.335864	172.3498
5400	0.436811	136.4786	6.79254	-79.1925	0.048313	-116.144	0.334212	167.6101
5500	0.448229	131.1618	6.608538	-83.5489	0.047742	-119.197	0.337723	162.7581
5600	0.458741	125.8601	6.460463	-87.804	0.047224	-122.079	0.346452	158.0309
5700	0.476482	121.0845	6.279033	-92.0021	0.046819	-125.265	0.359399	153.2462
5800	0.493574	116.483	6.126505	-96.2338	0.046407	-128.278	0.372718	149.2789
5900	0.510235	112.0889	6.015478	-100.445	0.046071	-131.302	0.385573	145.8469
6000	0.529772	108.3059	5.87094	-104.55	0.045766	-134.468	0.395866	142.478

## ABSOLUTE MAXIMUM RATINGS

Table 3.

Parameter	Rating
Supply Voltage, $V_{POS}$	6.5 V
Input Power (50 $\Omega$ Impedance)	18 dBm
Internal Power Dissipation (Pad Soldered to Ground)	400 mW
Maximum Junction Temperature	150°C
Operating Temperature Range	–40°C to +105°C
Storage Temperature Range	–65°C to +150°C

Stresses above those listed under Absolute Maximum Ratings may cause permanent damage to the device. This is a stress rating only; functional operation of the device at these or any other conditions above those indicated in the operational section of this specification is not implied. Exposure to absolute maximum rating conditions for extended periods may affect device reliability.

## THERMAL RESISTANCE

Table 4 lists the junction-to-air thermal resistance ( $\theta_{JA}$ ) and the junction-to-case thermal resistance ( $\theta_{JC}$ ) for the ADL5545.

Table 4. Thermal Resistance

Package Type	$\theta_{JA}$ <sup>1</sup>	$\theta_{JC}$ <sup>2</sup>	Unit
3-Lead SOT-89 (RK-3)	53	15	°C/W

<sup>1</sup> Measured on the ADL5545 evaluation board. For more information about board layout, see the Soldering Information and Recommended PCB Land Pattern section.

<sup>2</sup> Based on simulation with a standard JEDEC board per JESD51.

## ESD CAUTION



**ESD (electrostatic discharge) sensitive device.** Charged devices and circuit boards can discharge without detection. Although this product features patented or proprietary protection circuitry, damage may occur on devices subjected to high energy ESD. Therefore, proper ESD precautions should be taken to avoid performance degradation or loss of functionality.



## PIN CONFIGURATION AND FUNCTION DESCRIPTIONS

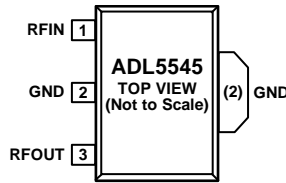

**NOTES**

1. THE EXPOSED PAD ENCOMPASSES PIN 2 AND THE TAB AT THE TOP SIDE OF THE PACKAGE. SOLDER THE EXPOSED PAD TO A LOW IMPEDANCE GROUND PLANE FOR ELECTRICAL GROUNDING AND THERMAL TRANSFER.

11385-002

Figure 2. Pin Configuration

Table 5. Pin Function Descriptions

Pin No.	Mnemonic	Description
1	RFIN	RF Input. This pin requires a dc blocking capacitor.
2	GND	Ground. Connect this pin to a low impedance ground plane.
3	RFOUT	RF Output and Supply Voltage. DC bias is provided to this pin through an inductor that is connected to the external power supply. The RF path requires a dc blocking capacitor.
	EPAD	Exposed Pad. The exposed pad encompasses Pin 2 and the tab at the top side of the package. Solder the exposed pad to a low impedance ground plane for electrical grounding and thermal transfer.

# TYPICAL PERFORMANCE CHARACTERISTICS

## 500 MHz TO 4 GHz FREQUENCY BAND

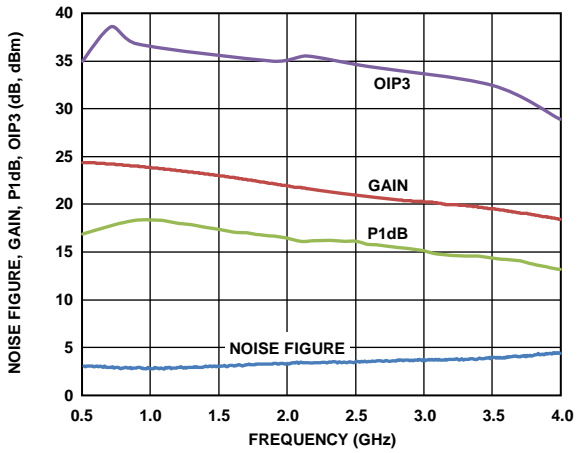

Figure 3. Noise Figure, Gain, P1dB, and OIP3 vs. Frequency

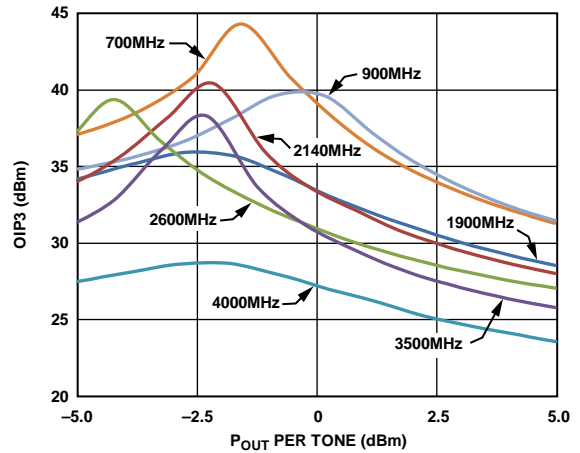

Figure 6. OIP3 vs. Output Power ( $P_{out}$ ) and Frequency

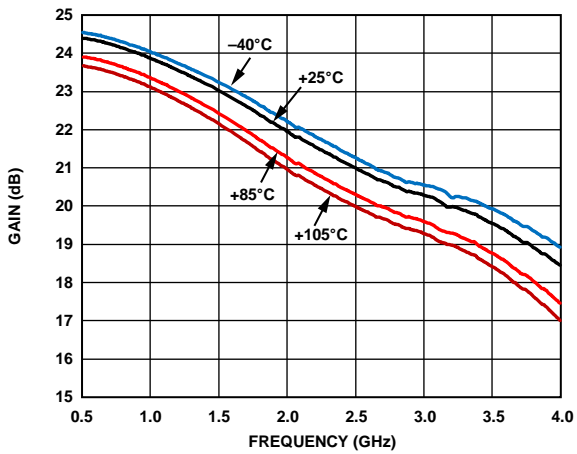

Figure 4. Gain vs. Frequency and Temperature

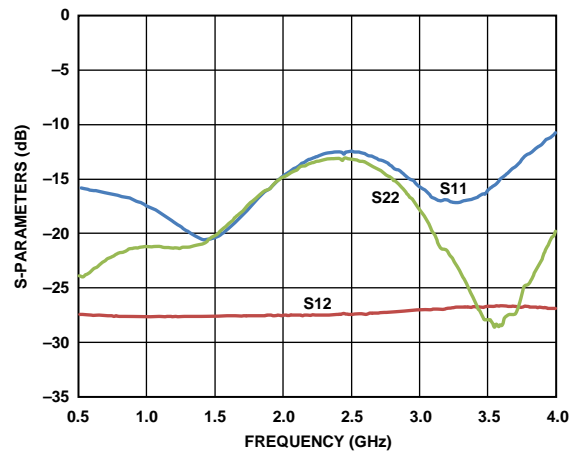

Figure 7. Input Return Loss ( $S_{11}$ ), Output Return Loss ( $S_{22}$ ), and Reverse Isolation ( $S_{12}$ ) vs. Frequency

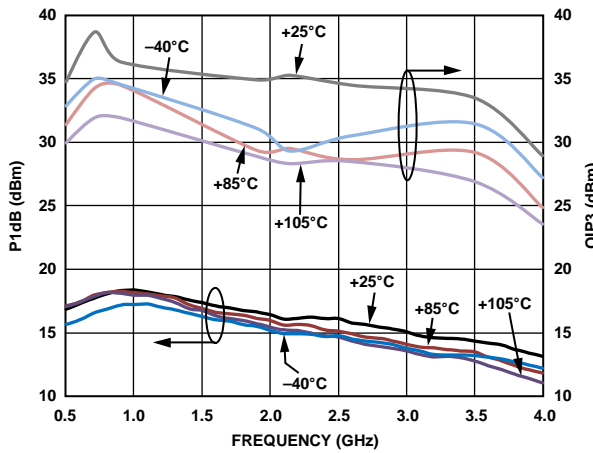

Figure 5. P1dB and OIP3 vs. Frequency and Temperature

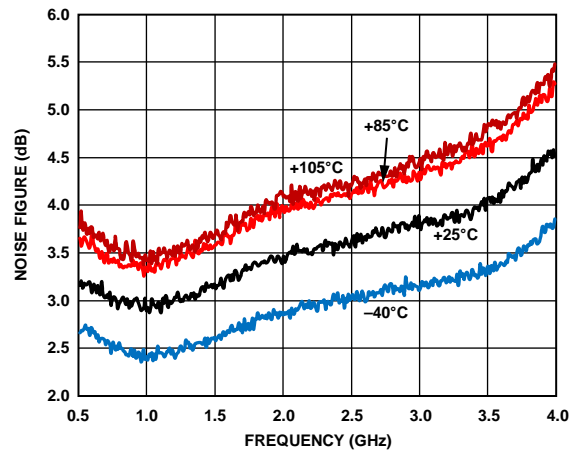

Figure 8. Noise Figure vs. Frequency and Temperature

100 MHz TO 500 MHz FREQUENCY BAND

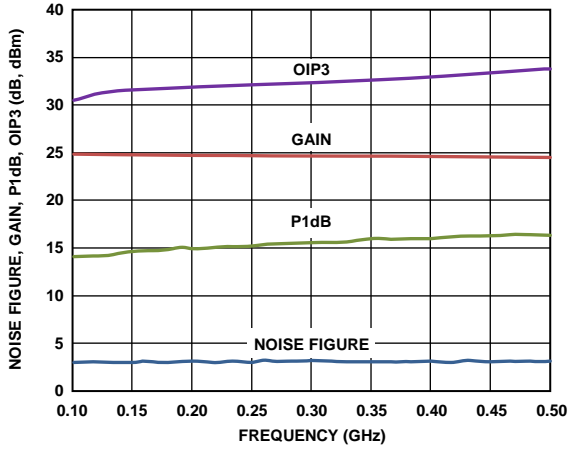

Figure 9. Noise Figure, Gain, P1dB, and OIP3 vs. Frequency, Low Frequency Configuration

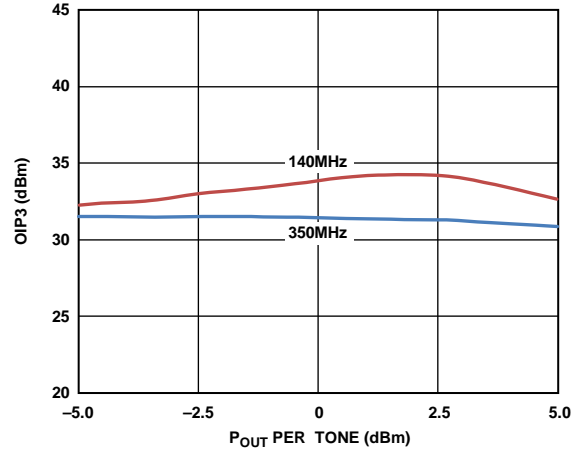

Figure 12. OIP3 vs. Output Power ( $P_{OUT}$ ) and Frequency, Low Frequency Configuration

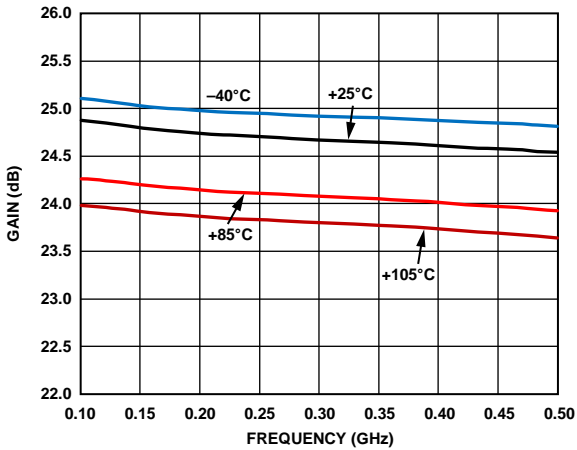

Figure 10. Gain vs. Frequency and Temperature, Low Frequency Configuration

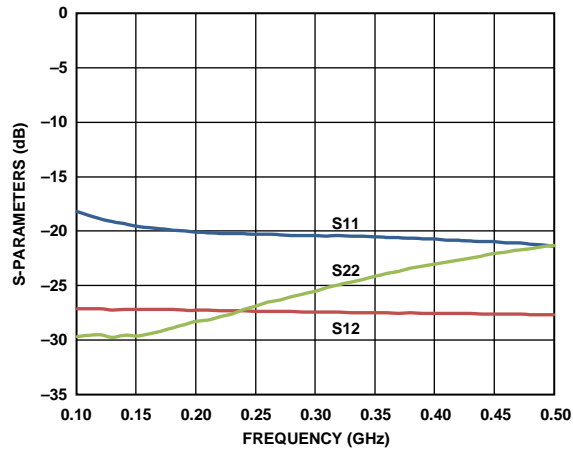

Figure 13. Input Return Loss ( $S_{11}$ ), Output Return Loss ( $S_{22}$ ), and Reverse Isolation ( $S_{12}$ ) vs. Frequency, Low Frequency Configuration

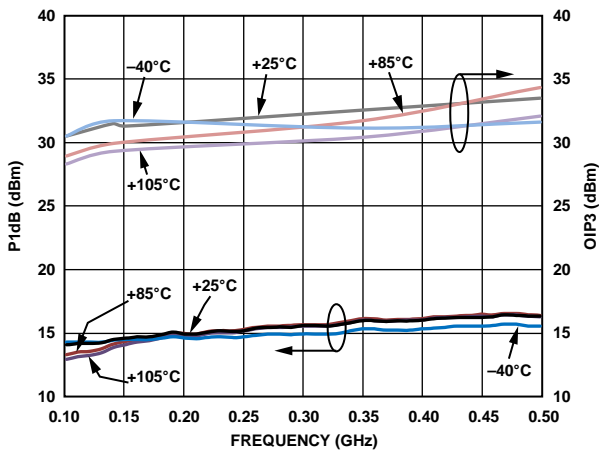

Figure 11. P1dB and OIP3 vs. Frequency and Temperature, Low Frequency Configuration

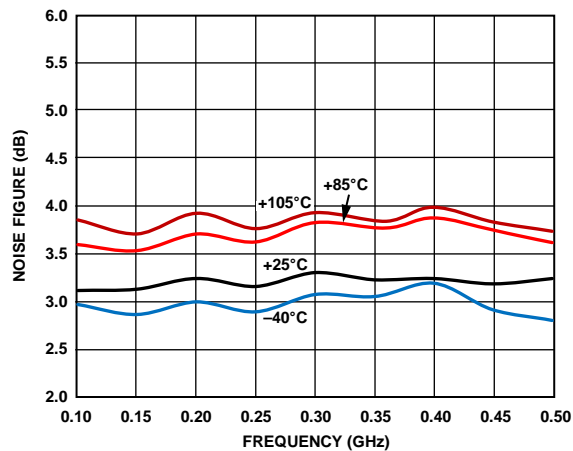

Figure 14. Noise Figure vs. Frequency and Temperature, Low Frequency Configuration

4 GHz TO 6 GHz FREQUENCY BAND

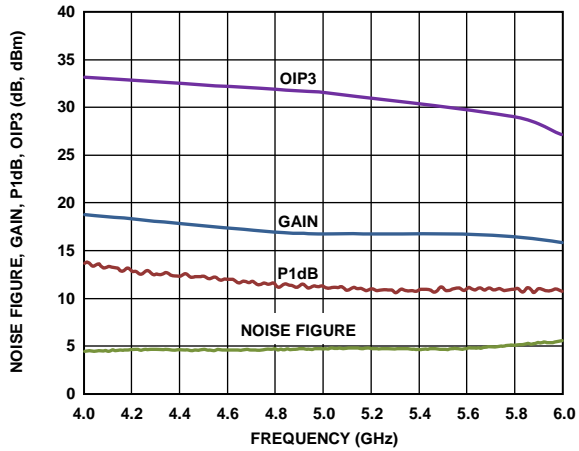

Figure 15. Noise Figure, Gain, P1dB, and OIP3 vs. Frequency, High Frequency Configuration

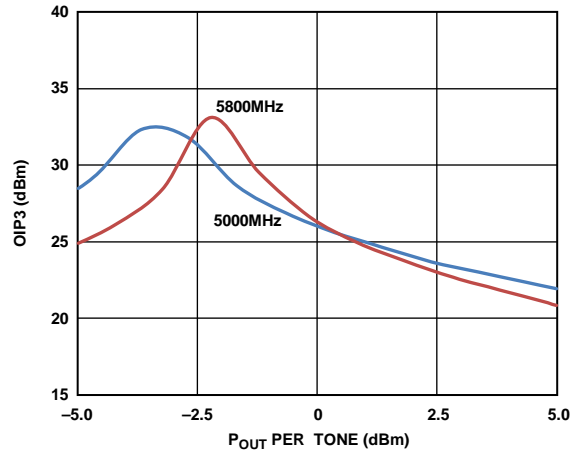

Figure 18. OIP3 vs. Output Power ( $P_{OUT}$ ) and Frequency, High Frequency Configuration

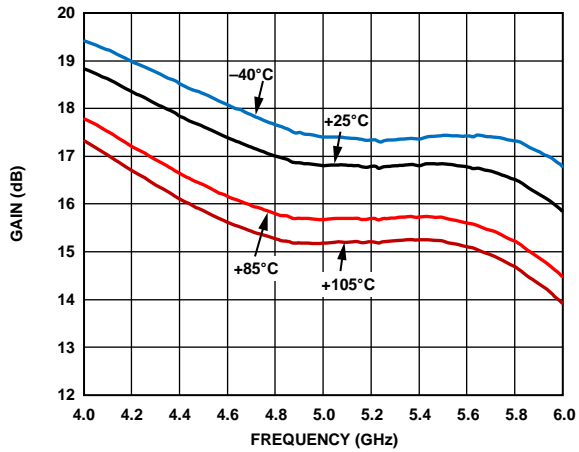

Figure 16. Gain vs. Frequency and Temperature, High Frequency Configuration

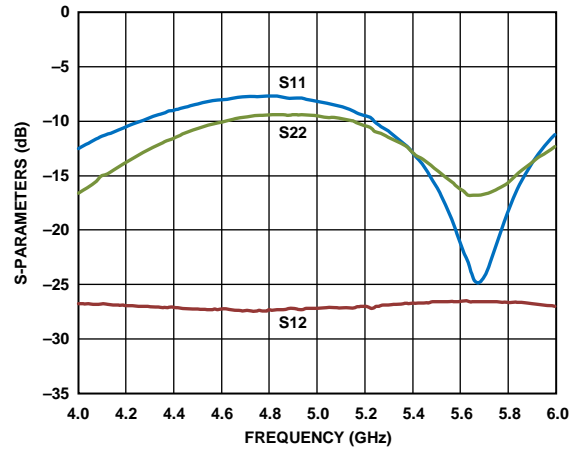

Figure 19. Input Return Loss (S11), Output Return Loss (S22), and Reverse Isolation (S12) vs. Frequency, High Frequency Configuration

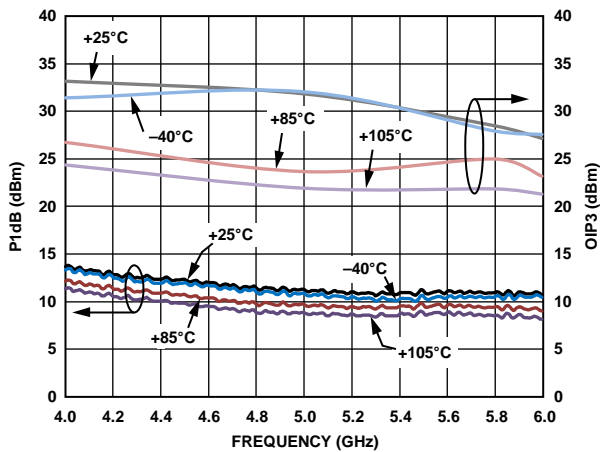

Figure 17. P1dB and OIP3 vs. Frequency and Temperature, High Frequency Configuration

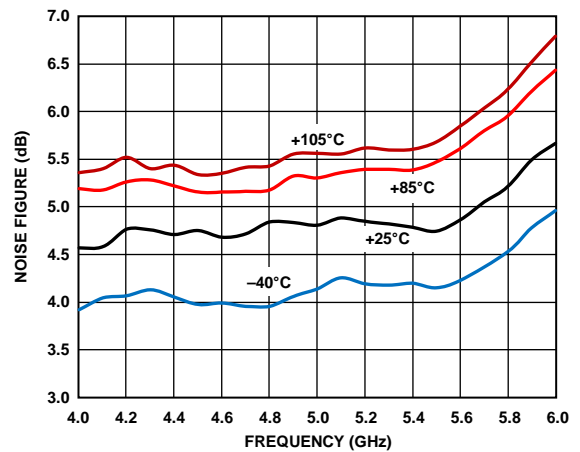

Figure 20. Noise Figure vs. Frequency and Temperature, High Frequency Configuration

GENERAL

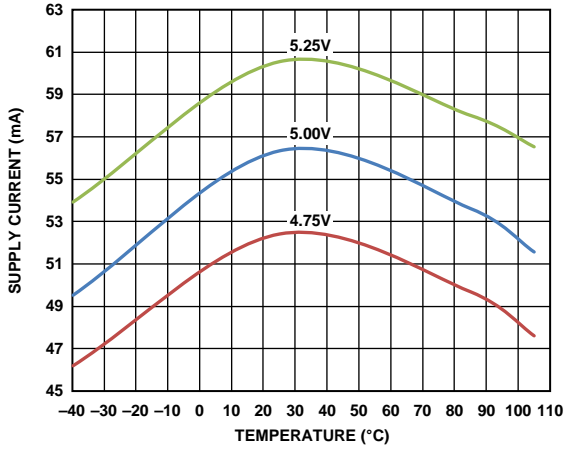

Figure 21. Supply Current vs. Temperature

11385-021

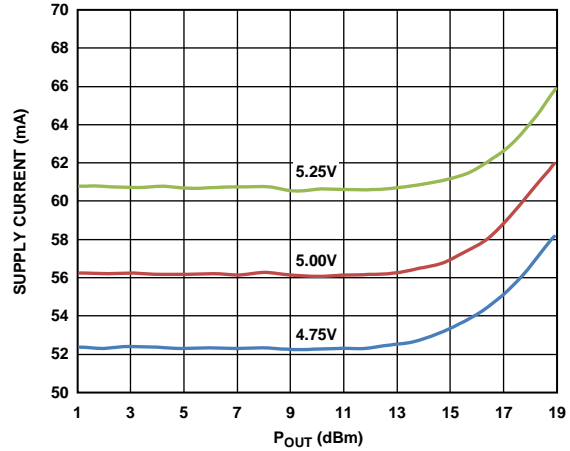

Figure 24. Supply Current vs. P<sub>OUT</sub> at 900 MHz

11385-024

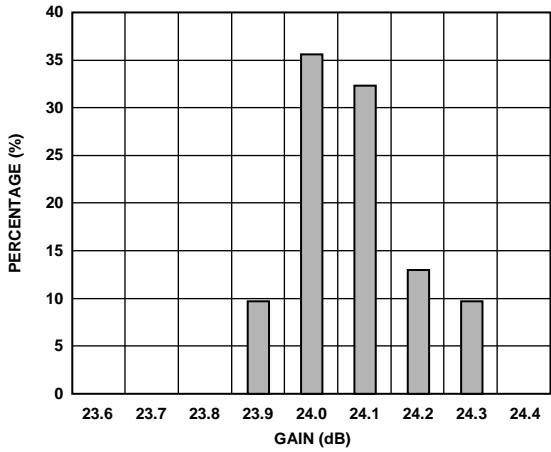

Figure 22. Gain Distribution at 900 MHz

11385-022

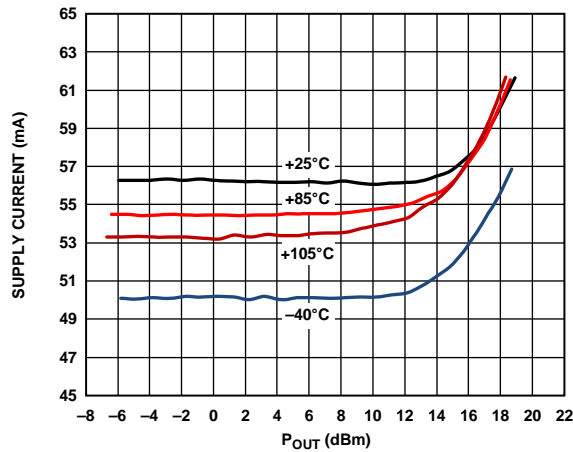

Figure 25. Supply Current vs. P<sub>OUT</sub> and Temperature at 900 MHz

11385-100

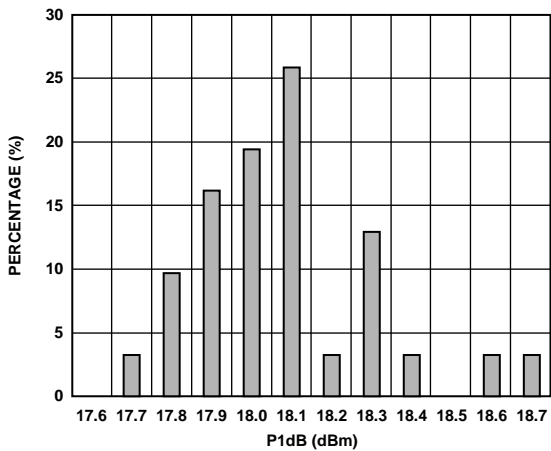

Figure 23. P<sub>1dB</sub> Distribution at 900 MHz

11385-023

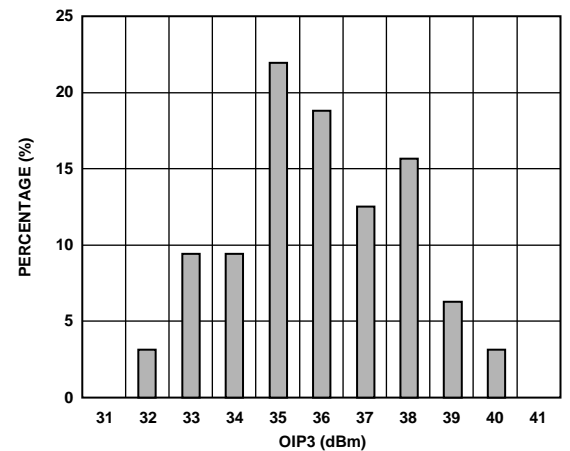

Figure 26. OIP<sub>3</sub> Distribution at 900 MHz, P<sub>OUT</sub> = -3 dBm per Tone

11385-025

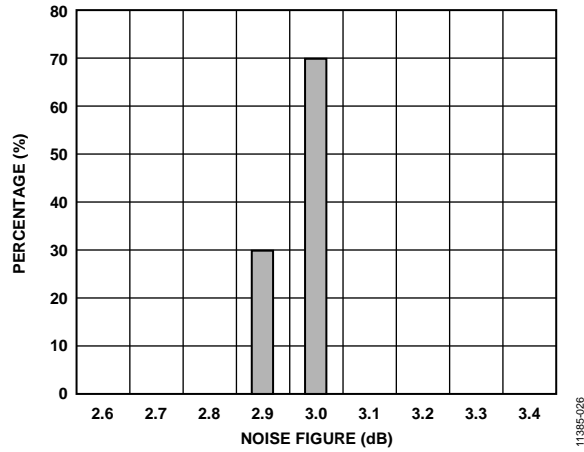

Figure 27. Noise Figure Distribution at 900 MHz

11385-026

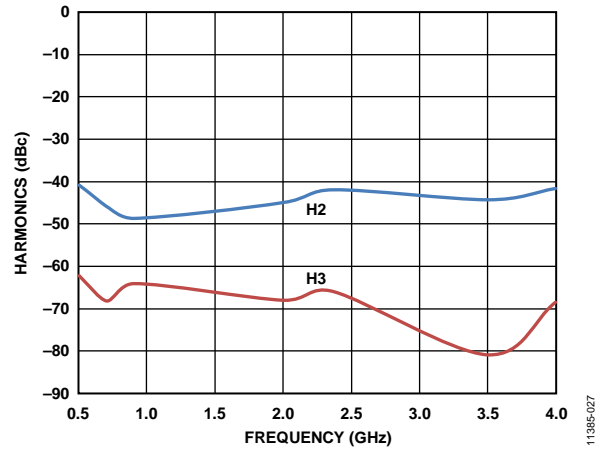

Figure 28. Single-Tone Harmonics vs. Frequency,  $P_{OUT} = 0$  dBm

11385-027

# APPLICATIONS INFORMATION

## BASIC CONNECTIONS

Figure 29 shows the basic connections for operating the ADL5545. The device supports operation from 30 MHz to 6 GHz. However, for optimal performance at lower and higher frequency bands, the board configuration must be adjusted. Table 6 lists the recommended board configuration to operate the device at various frequency bands.

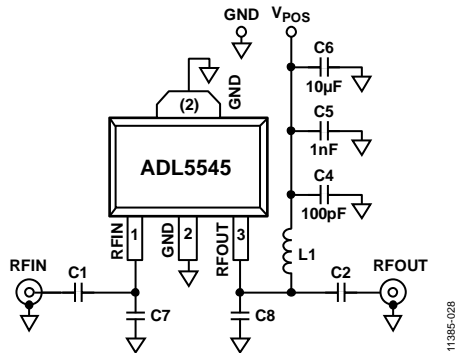

Figure 29. Basic Connections

A 5 V dc bias is supplied to the amplifier through the bias inductor connected to RFOUT (Pin 3). The bias voltage must be decoupled using 100 pF, 1 nF, and 10 μF power supply decoupling capacitors. The typical current consumption for the ADL5545 is 56 mA.

At low and high frequencies, the device exhibits improved performance with the suggested setup configuration listed in Table 6. Figure 30 to Figure 33 provide a comparison of the performance of the device at the 100 MHz to 500 MHz and 4 GHz to 6 GHz bands when driven with the optimal setup configuration and the default setup configuration.

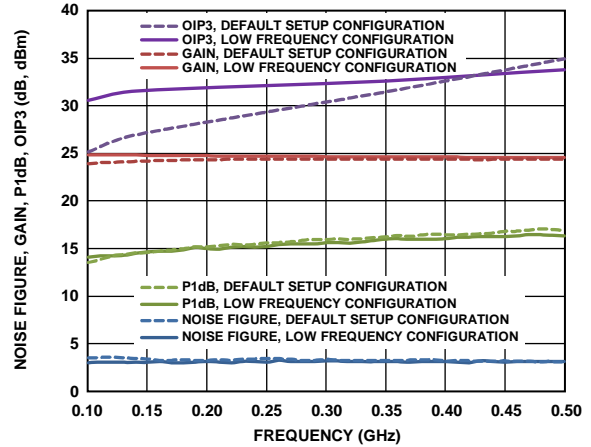

Figure 30. Noise Figure, Gain, P1dB, and OIP3 vs. Frequency, 100 MHz to 500 MHz, Comparison of Performance with the Optimized Settings and the Default Configuration

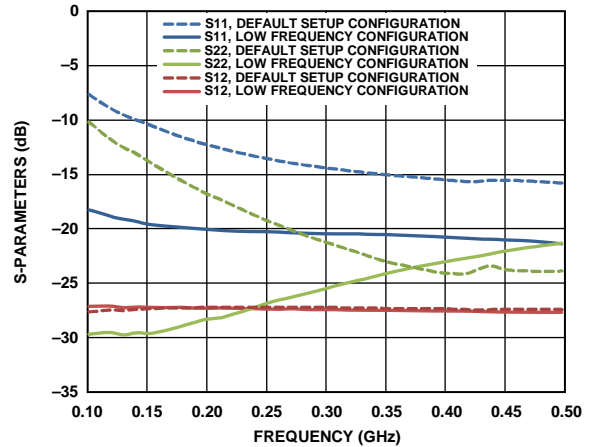

Figure 31. Return Loss and Reverse Isolation, 100 MHz to 500 MHz, Comparison of Performance with the Optimized Settings and the Default Configuration

Table 6. Recommended Components for Basic Connections

Frequency Band	AC Coupling Capacitors (0402)		DC Bias Inductor (0603HP)	High Frequency Matching Capacitors (0402)	
	C1	C2	L1	C7	C8
100 MHz to 500 MHz	100 nF	100 nF	1000 nH	Do not install	Do not install
500 MHz to 4 GHz (default)	100 pF	100 pF	100 nH	Do not install	Do not install
4 GHz to 6 GHz	100 pF	100 pF	12 nH	0.1 pF	0.1 pF

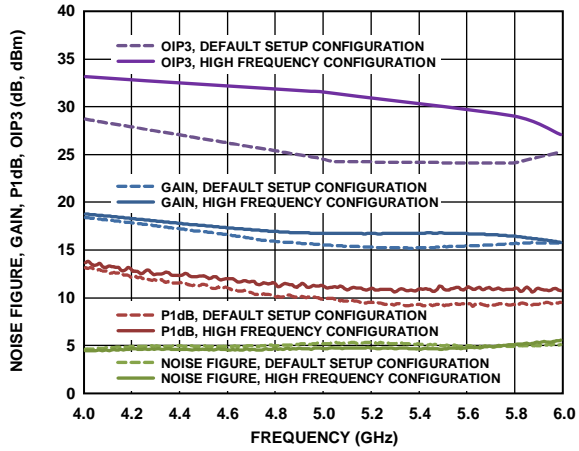

Figure 32. Noise Figure, Gain, P1dB, and OIP3 vs. Frequency, 4 GHz to 6 GHz, Comparison of Performance with the Optimized Settings and the Default Configuration

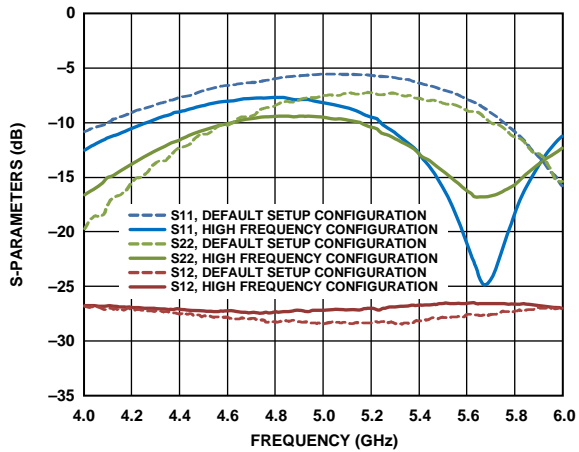

Figure 33. Return Loss and Reverse Isolation, 4 GHz to 6 GHz, Comparison of Performance with the Optimized Settings and the Default Configuration

### SOLDERING INFORMATION AND RECOMMENDED PCB LAND PATTERN

Figure 34 shows the recommended land pattern for the ADL5545. To minimize thermal impedance, the exposed pad on the underside of the SOT-89 package is soldered to a ground plane, along with Pin 2. If multiple ground layers exist, stitch the layers together using vias.

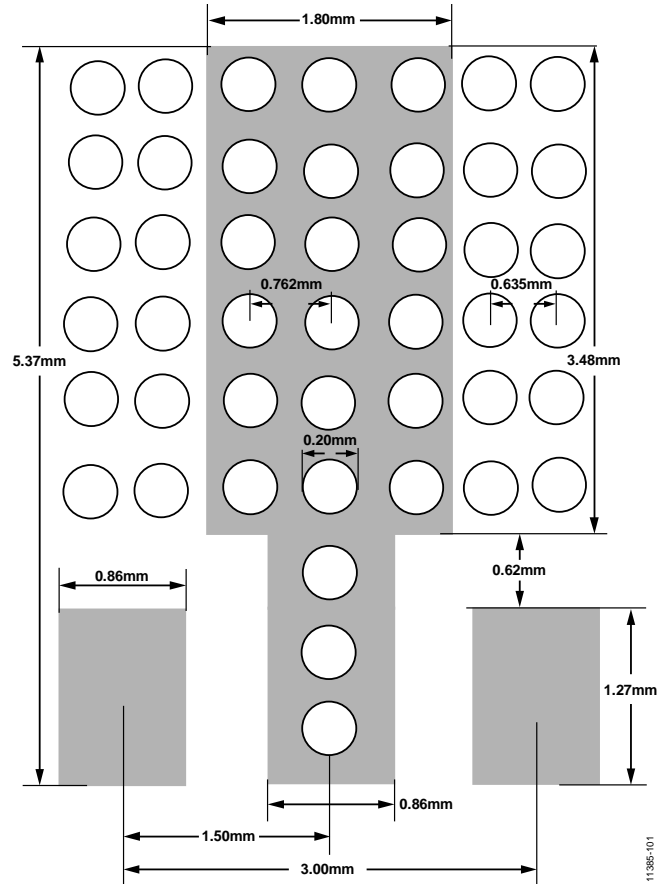

Figure 34. Recommended Land Pattern

The land pattern on the ADL5545 evaluation board provides a measured thermal resistance ( $\theta_{JA}$ ) of 53°C/W. To measure  $\theta_{JA}$ , the temperature at the top of the SOT-89 package is found with an IR temperature gun. Thermal simulation suggests a junction temperature 10°C higher than the top-of-package temperature. With additional measurements of the ambient temperature and I/O power,  $\theta_{JA}$  can be determined.



**OPERATION DOWN TO 30 MHz**

To operate the ADL5545 at frequencies below 100 MHz, a feedback network must be implemented between the input and output ports of the device to ensure stability. Figure 35 shows a sample configuration used to evaluate the device at frequencies below 100 MHz. Figure 36 to Figure 38 demonstrate the performance of the device in this configuration.

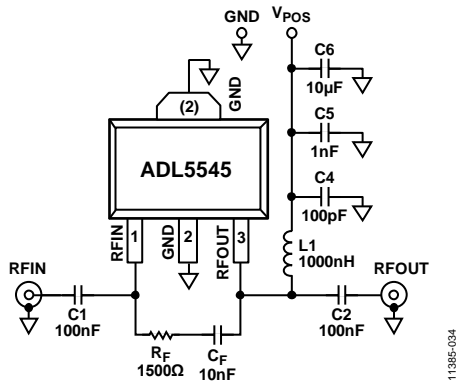

Figure 35. Setup for Low Frequency Operation Down to 30 MHz

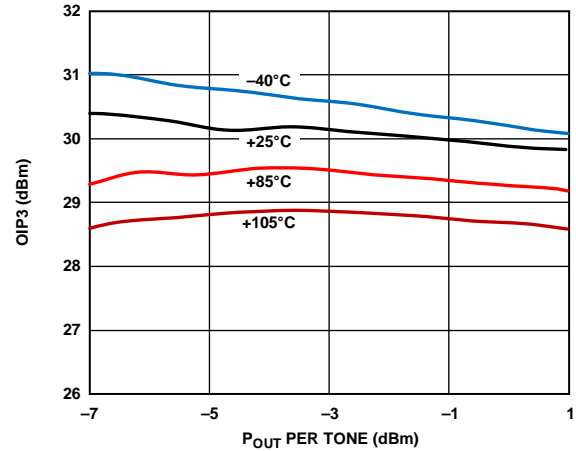

Figure 38. OIP3 vs. POUT at 30 MHz

**W-CDMA ACPR PERFORMANCE**

Figure 39 shows a plot of the adjacent channel power ratio (ACPR) vs. POUT for the ADL5545. The signal type used is a single wideband code division multiple access (W-CDMA) carrier (Test Model 1-64) at 2140 MHz. This signal is generated by a very low ACPR source. ACPR is measured at the output by a high dynamic range spectrum analyzer that incorporates an instrument noise-correction function.

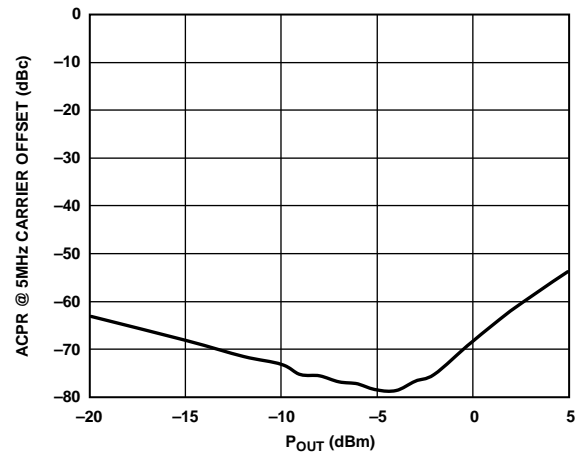

Figure 39. ACPR vs. POUT, Single W-CDMA Carrier (Test Model 1-64) at 2140 MHz

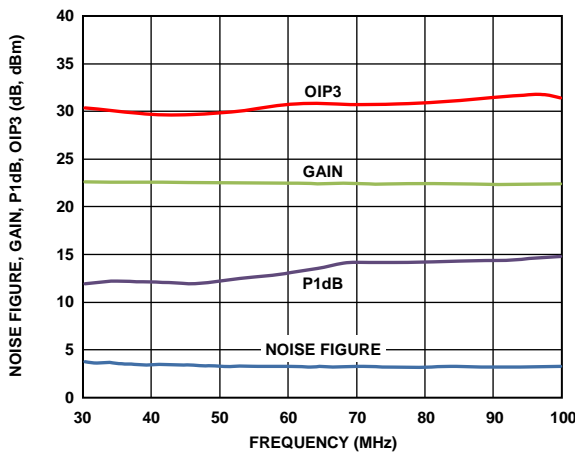

Figure 36. Noise Figure, Gain, P1dB, and OIP3 vs. Frequency, 30 MHz to 100 MHz

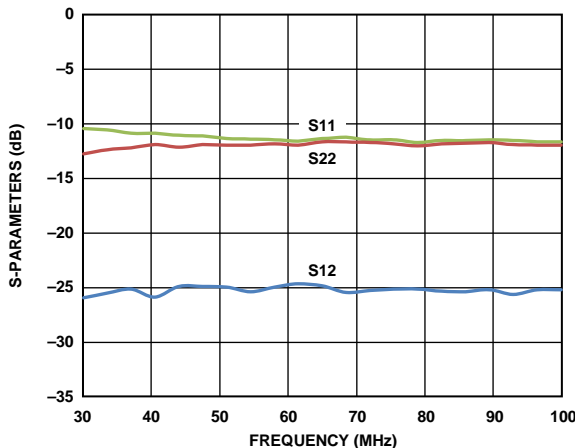

Figure 37. Return Loss and Reverse Isolation, 30 MHz to 100 MHz

### EVALUATION BOARD

Figure 40 shows the ADL5545 evaluation board layout. Figure 41 shows the schematic for the evaluation board. The board is powered by a single 5 V supply. Table 7 lists the components used on the evaluation board. Power can be applied to the board through clip-on leads ( $V_{SUP}$ , GND).

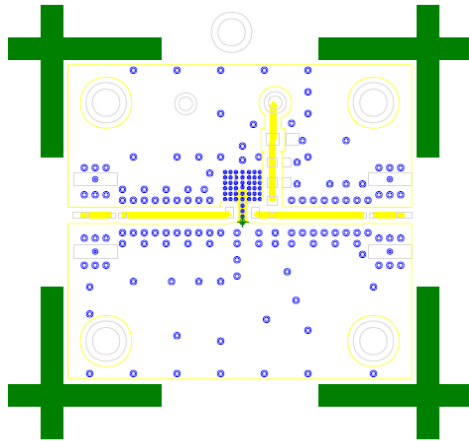

Figure 40. Evaluation Board Layout (Top)

11385-039

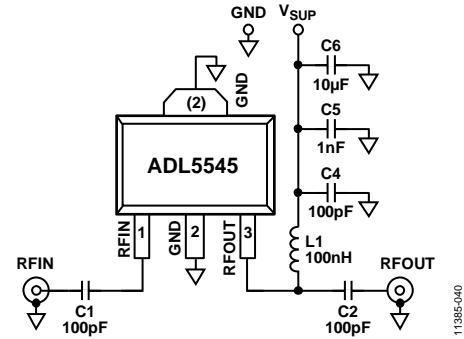

Figure 41. Evaluation Board Schematic

11385-040

Table 7. Evaluation Board Configuration Options

Component	Function	Default Value
C1, C2	AC coupling capacitors	100 pF, 0402
L1	DC bias inductor	100 nH, 0603 (Coilcraft 0603HP or equivalent)
$V_{SUP}$ and GND	Clip-on terminals for power supply	
C4, C5, C6	Power supply decoupling capacitors	C4: 100 pF, 0603 C5: 1 nF, 0603 C6: 10 $\mu$ F, 1206

OUTLINE DIMENSIONS

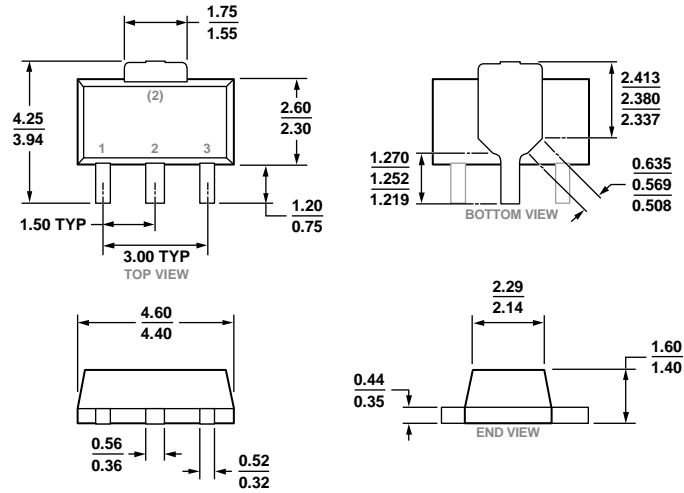

COMPLIANT TO JEDEC STANDARDS TO-243

Figure 42. 3-Lead Small Outline Transistor Package [SOT-89] (RK-3)

Dimensions shown in millimeters

ORDERING GUIDE

Model <sup>1</sup>	Temperature Range	Package Description	Package Option
ADL5545ARKZ-R7	-40°C to +105°C	3-Lead SOT-89, 7" Tape and Reel	RK-3
ADL5545-EVALZ	-40°C to +105°C	Evaluation Board	

<sup>1</sup> Z = RoHS Compliant Part.

**NOTES**

**NOTES**