

FEATURES

- 120 kB transmission rate
- Small (0.1 μ F) charge pump capacitors
- Single 5 V power supply
- Meets TIA/EIA-232-E and V.28 specifications
- 2 drivers and 2 receivers
- On-board dc-to-dc converters
- ± 9 V output swing with 5 V supply
- Low power BiCMOS: 2.5 mA I_{CC}
- ± 30 V receiver input levels

APPLICATIONS

- Computers
- Peripherals
- Modems
- Printers
- Instruments

GENERAL DESCRIPTION

The [ADM202](#) is a 2-channel RS-232 line driver/receiver pair designed to operate from a single 5 V power supply. A highly efficient on-chip charge pump design permits RS-232 levels to be developed using charge pump capacitors as small as 0.1 μ F. This converter generates ± 10 V RS-232 output levels.

The [ADM202](#) meets or exceeds the TIA/EIA-232-E and V.28 specifications. Fast driver slew rates permit 120 kB operation, and high drive currents allow extended cable lengths.

TYPICAL APPLICATION CIRCUIT

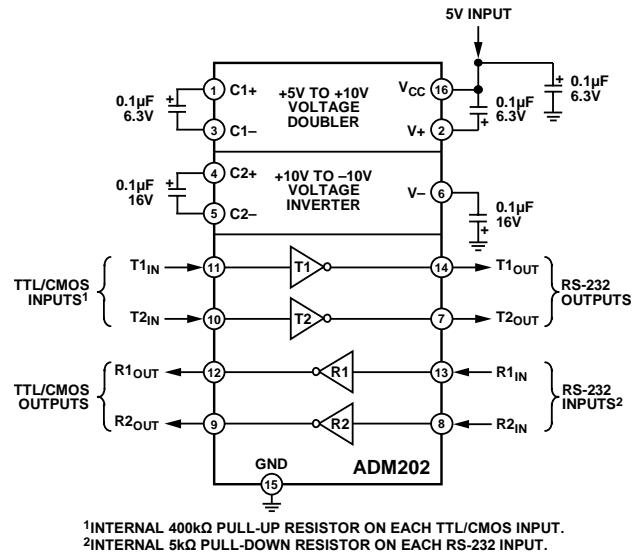

Figure 1.

An epitaxial BiCMOS construction minimizes power consumption to 10 mW and guards against latch-up. Overvoltage protection is provided, allowing the receiver inputs to withstand continuous voltages in excess of ± 30 V. In addition, all pins contain ESD protection to levels greater than 2 kV.

The [ADM202](#) is available in a 16-lead PDIP and both narrow and wide 16-lead SOIC packages.

ADM202* Product Page Quick Links

Last Content Update: 11/01/2016

[Comparable Parts](#)

View a parametric search of comparable parts

[Documentation](#)

Data Sheet

- [ADM202: High Speed, 5 V, 0.1 \$\mu\$ F CMOS RS-232 Driver/Receiver Data Sheet](#)

[Software and Systems Requirements](#)

- [ADI RS-485/RS-422 Cross Reference Guide](#)
- [RS-232 Transceivers Cross Reference Guide](#)

[Reference Materials](#)

Solutions Bulletins & Brochures

- [RS-232 Transceivers Applications Bulletin \(Summer 2008\)](#)

Technical Articles

- [Interface Primer](#)

[Design Resources](#)

- [ADM202 Material Declaration](#)
- [PCN-PDN Information](#)
- [Quality And Reliability](#)
- [Symbols and Footprints](#)

[Discussions](#)

View all ADM202 EngineerZone Discussions

[Sample and Buy](#)

Visit the product page to see pricing options

[Technical Support](#)

Submit a technical question or find your regional support number

TABLE OF CONTENTS

Features	1	Typical Performance Characteristics	6
Applications.....	1	Theory of Operation	7
Typical Application Circuit	1	Applications Information	8
General Description	1	Charge Pump DC-to-DC Voltage Converter	8
Revision History	2	TTL/CMOS to RS-232 Transmitters (Drivers)	8
Specifications.....	3	RS-232 to TTL/CMOS Receivers	8
Absolute Maximum Ratings.....	4	Outline Dimensions	9
ESD Caution.....	4	Ordering Guide	10
Pin Configuration and Function Descriptions.....	5		

REVISION HISTORY

8/2016—Rev. A to Rev. B

Updated Format.....	Universal	Changes to Table 2.....	4
Deleted ADM203.....	Universal	Changes to Table 3.....	5
Changes to Typical Application Circuit Section Heading.....	1	Changes to Theory of Operation Section.....	7
Deleted ADM203 Functional Block Diagram Figure;		Changes to TTL/CMOS to RS-232 Transmitters (Drivers)	
Renumbered Sequentially.....	1	Section and RS-232 to TLL/CMOS Receivers Section	8
Changes to Features Section and General Description Section .	1	Updated Outline Dimensions	9
Deleted ADM203 Pin Configuration Figure and Figure 1	3	Changes to Ordering Guide	10
Changed T_{IN} to T_{xIN}	Throughout		

1/2001—Rev. 0 to Rev. A

SPECIFICATIONS

$V_{CC} = 5\text{ V} \pm 10\%$, ($C1$ to $C4 = 0.1\ \mu\text{F}$). All specifications T_{MIN} to T_{MAX} , unless otherwise noted.

Table 1.

Parameter	Min	Typ	Max	Unit	Test Conditions/Comments
OUTPUT VOLTAGE SWING	± 5	± 9		V	$V_{CC} = 5\text{ V} \pm 5\%$; $T1_{OUT}$ and $T2_{OUT}$ loaded with $3\text{ k}\Omega$ to GND
	± 5	± 9		V	$V_{CC} = 5\text{ V} \pm 10\%$; $T_A = 25^\circ\text{C}$; $T1_{OUT}$ and $T2_{OUT}$ loaded with $3\text{ k}\Omega$ to GND
V_{CC} POWER SUPPLY CURRENT (I_{CC})		2.5	6.0	mA	No load; $T1_{IN}$ and $T2_{IN} = V_{CC}$, or $T1_{IN}$ and $T2_{IN} = \text{GND}$
INPUT LOGIC THRESHOLD					
Low, V_{INL}			0.8	V	$T_{X_{IN}}$
High, V_{INH}	2.4			V	$T_{X_{IN}}$
LOGIC PULL-UP CURRENT		12	25	μA	$T_{X_{IN}} = 0\text{ V}$
RS-232 INPUT					
Voltage Range	-30		+30	V	
Threshold					
Low	0.8	1.2		V	
High		1.6	2.4	V	
Hysteresis	0.2	0.4	1.0	V	
Resistance	3	5	7	$\text{k}\Omega$	$T_A = 0^\circ\text{C}$ to 85°C
TTL/CMOS Output Voltage					
Low, V_{OL}			0.4	V	$I_{OUT} = 1.6\text{ mA}$
High, V_{OH}	3.5			V	$I_{OUT} = -1.0\text{ mA}$
PROPAGATION DELAY		0.3	5	μs	RS-232 to TTL
TRANSITION REGION SLEW RATE		8		$\text{V}/\mu\text{s}$	$R_L = 3\text{ k}\Omega$, $C_L = 1000\text{ pF}$, measured from $+3\text{ V}$ to -3 V or -3 V to $+3\text{ V}$
BAUD RATE	120			kB	$R_L = 3\text{ k}\Omega$, $C_L = 1\text{ nF}$
OUTPUT					
Output Resistance	300			Ω	$V_{CC} = V+ = V- = 0\text{ V}$, $V_{OUT} = \pm 2\text{ V}$
RS-232 Output Short-Circuit Current		± 10	± 60	mA	

ABSOLUTE MAXIMUM RATINGS

$T_A = 25^\circ\text{C}$, unless otherwise noted.

Table 2.

Parameter	Rating
V_{CC}	6 V
V+	$(V_{CC} - 0.3 \text{ V})$ to +14 V
V-	+0.3 V to -14 V
Input Voltages	
$T1_{IN}, T2_{IN}$	-0.3 V to $(V_{CC} + 0.3 \text{ V})$
$R1_{IN}, R2_{IN}$	$\pm 30 \text{ V}$
Output Voltages	
$T1_{OUT}, T2_{OUT}$	$((V+) + 0.3 \text{ V})$ to $((V-) - 0.3 \text{ V})$
$R1_{OUT}, R2_{OUT}$	-0.3 V to $(V_{CC} + 0.3 \text{ V})$
Short-Circuit Duration	
$T1_{OUT}, T2_{OUT}$	Continuous
Power Dissipation	
16-Lead PDIP (N-16)	470 mW
16-Lead SOIC (R-16)	600 mW
16-Lead SOIC (RW-16)	500 mW
Thermal Impedance, θ_{JA}	
16-Lead PDIP (N-16)	135°C/W
16-Lead SOIC (R-16)	105°C/W
16-Lead SOIC (RW-16)	105°C/W
Operating Temperature Range	
Commercial (J Version)	0°C to 70°C
Storage Temperature Range	-65°C to +150°C
Lead Temperature Soldering	
Vapor Phase (60 sec)	215°C
Infrared (15 sec)	220°C
ESD Rating	>2000 V

Stresses at or above those listed under Absolute Maximum Ratings may cause permanent damage to the product. This is a stress rating only; functional operation of the product at these or any other conditions above those indicated in the operational section of this specification is not implied. Operation beyond the maximum operating conditions for extended periods may affect product reliability.

ESD CAUTION



ESD (electrostatic discharge) sensitive device.

Charged devices and circuit boards can discharge without detection. Although this product features patented or proprietary protection circuitry, damage may occur on devices subjected to high energy ESD. Therefore, proper ESD precautions should be taken to avoid performance degradation or loss of functionality.

PIN CONFIGURATION AND FUNCTION DESCRIPTIONS

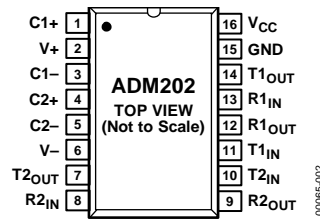

Figure 2. Pin Configuration

Table 3. Pin Function Descriptions

Pin No.	Mnemonic	Description
1	C1+	External Positive Capacitor 1 Connection. The positive terminal is connected to this pin.
2	V+	Internally Generated Positive Supply (+10 V nominal).
3	C1-	External Negative Capacitor 1 Connection. The negative terminal is connected to this pin.
4	C2+	External Positive Capacitor 2 Connection. The positive terminal is connected to this pin.
5	C2-	External Negative Capacitor 1 Connection. The negative terminal is connected to this pin.
6	V-	Internally Generated Negative Supply (-10 V Nominal).
7, 14	T2 _{OUT} , T1 _{OUT}	Transmitter (Driver) Outputs. These outputs are RS-232 levels (typically ± 10 V).
8, 13	R2 _{IN} , R1 _{IN}	Receiver Inputs. These inputs accept RS-232 signal levels. An internal 5 k Ω pull-down resistor to GND is connected on each of these inputs.
9, 12	R2 _{OUT} , R1 _{OUT}	Receiver Outputs. These outputs are TTL/CMOS levels.
10, 11	T2 _{IN} , T1 _{IN}	Transmitter (Driver) Inputs. These inputs accept TTL/CMOS levels. An internal 400 k Ω pull-up resistor to V _{CC} is connected on each input.
15	GND	Ground. This pin must be connected to 0 V.
16	V _{CC}	Power Supply Input, 5 V \pm 10%.

TYPICAL PERFORMANCE CHARACTERISTICS

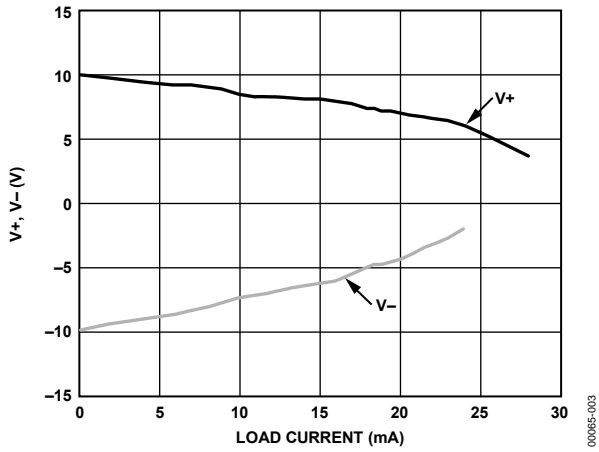

Figure 3. Charge Pump V+, V- vs. Load Current

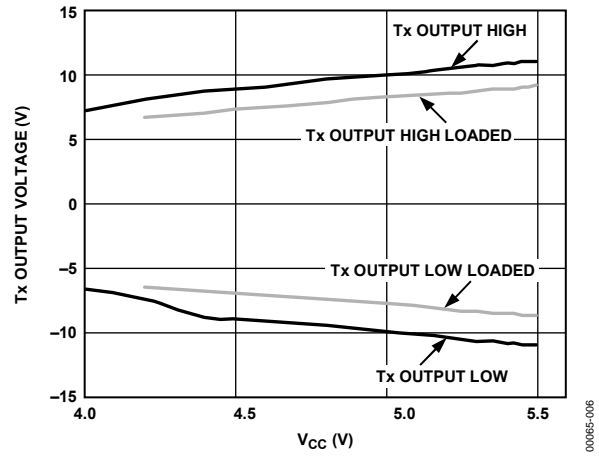

Figure 6. Transmitter (Tx) Output Voltage vs. V_{CC}

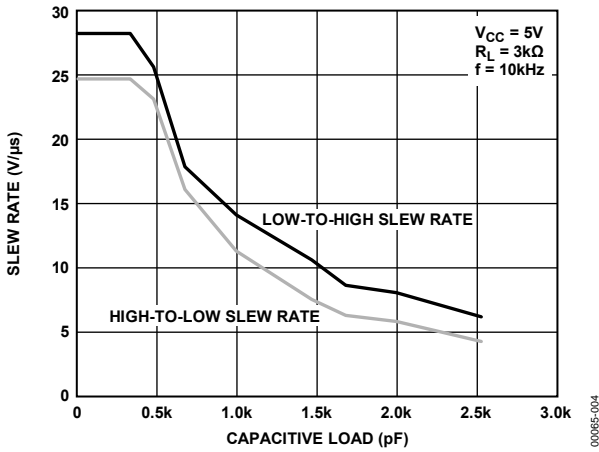

Figure 4. Transmitter Slew Rate vs. Capacitive Load

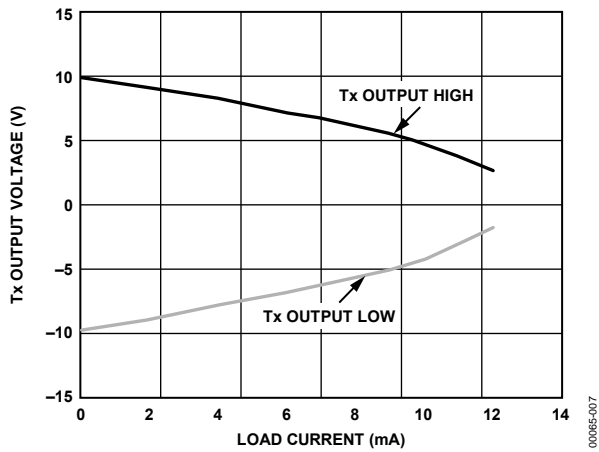

Figure 7. Transmitter (Tx) Output Voltage vs. Load Current

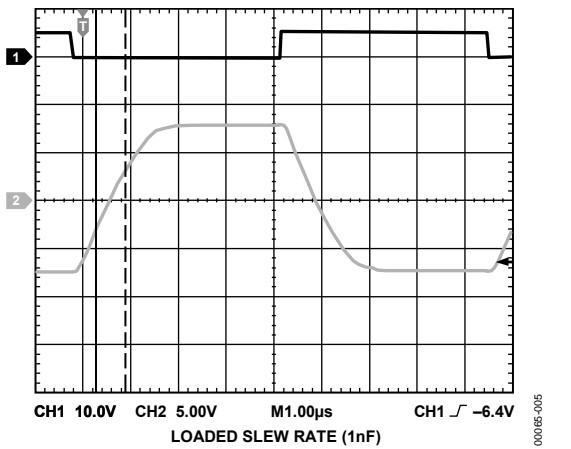

Figure 5. Transmitter Fully Loaded Slew Rate

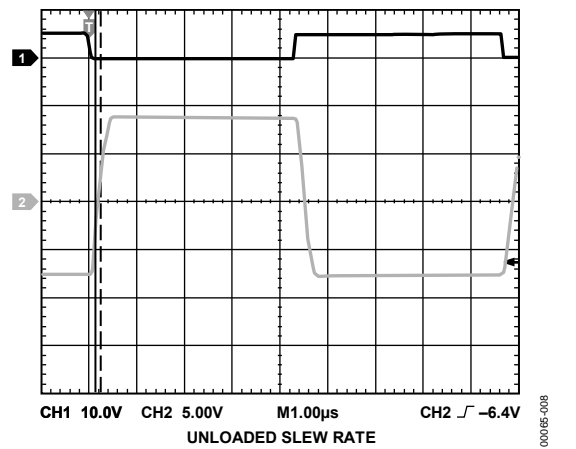

Figure 8. Transmitter Unloaded Slew Rate

THEORY OF OPERATION

The [ADM202](#) is an RS-232 driver/receiver designed to solve interface problems by meeting the TIA/EIA-232E specifications while using a single digital 5 V supply. The EIA standard requires that transmitters deliver ± 5 V minimum on the transmission channel and that receivers can accept signal levels down to ± 3 V. The device achieves this by integrating step-up voltage converters and level shifting transmitters and receivers

on the same chip. CMOS technology keeps the power dissipation to an absolute minimum.

The [ADM202](#) contains an internal voltage doubler and a voltage inverter that generates ± 10 V from the 5 V input. External 0.1 μ F capacitors are required for the internal voltage converter.

APPLICATIONS INFORMATION

The internal circuitry consists of three main sections, as follows:

- A charge pump dc-to-dc voltage converter
- TTL/CMOS to RS-232 transmitters
- RS-232 to TTL/CMOS receivers

CHARGE PUMP DC-TO-DC VOLTAGE CONVERTER

The charge pump voltage converter consists of an oscillator and a switching matrix. The converter generates a ± 10 V supply from the input 5 V level in two stages, using a switched capacitor technique as illustrated in Figure 9 and Figure 10. First, the 5 V input supply is doubled to 10 V using Capacitor C1 as the charge storage element. The 10 V level is then inverted to generate -10 V using C2 as the storage element.

Capacitors C3 and C4 reduce the output ripple. Their values are not critical and can be reduced if higher levels of ripple are acceptable. The charge pump capacitors, C1 and C2, can also be reduced at the expense of higher output impedance on the $V+$ and $V-$ supplies.

The $V+$ and $V-$ supplies can be used to power external circuitry if the current requirements are small.

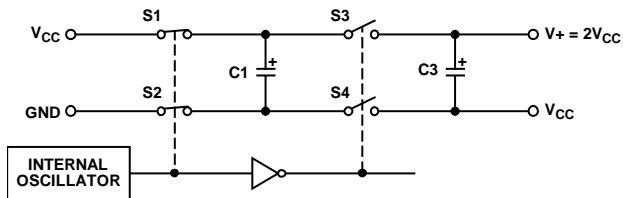

Figure 9. Charge Pump Voltage Doubler

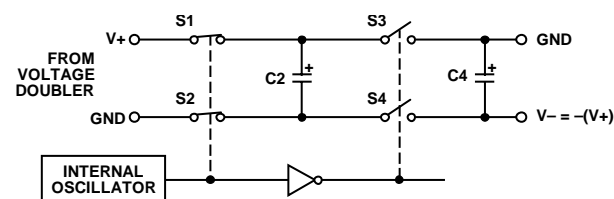

Figure 10. Charge Pump Voltage Inverter

TTL/CMOS TO RS-232 TRANSMITTERS (DRIVERS)

The drivers convert TTL/CMOS input levels into TIA/EIA-232-E output levels. With $V_{CC} = 5$ V and driving a typical TIA/EIA-232-E load, the output voltage swing is ± 9 V. Even under worst case conditions, the drivers are guaranteed to meet the ± 5 V TIA/EIA-232-E minimum requirement.

The input threshold levels are both TTL and CMOS compatible with the switching threshold set at $V_{CC}/4$. With a nominal $V_{CC} = 5$ V, the switching threshold is 1.25 V typical. Unused inputs can be left unconnected, as an internal 400 k Ω pull-up resistor pulls them high, forcing the outputs into a low state.

As required by the TIA/EIA-232-E standard, the slew rate is limited to less than 30 V/ μ s without the need for an external slew limiting capacitor, and the output impedance in the power-down state is greater than 300 Ω .

RS-232 TO TTL/CMOS RECEIVERS

The receivers are inverting level shifters that accept TIA/EIA-232-E input levels (± 5 V to ± 15 V) and translate them into 5 V TTL/CMOS levels. The inputs have internal 5 k Ω pull-down resistors to ground and are protected against overvoltages of up to ± 30 V. The guaranteed switching thresholds are 0.8 V (V_{INL}) and 2.4 V (V_{INH}), which are well within the ± 3 V TIA/EIA-232-E requirement. The low level threshold is deliberately positive because it ensures that an unconnected input is interpreted as a low level.

The receivers have a Schmitt triggered input with a hysteresis level of 0.5 V. This hysteresis level ensures error free reception, both for noisy inputs and for inputs with slow transition times.

OUTLINE DIMENSIONS

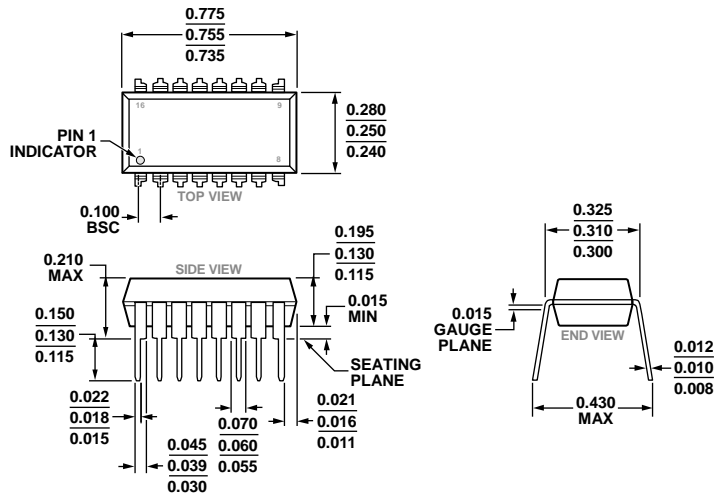

COMPLIANT TO JEDEC STANDARDS MS-001-BB

Figure 11. 16-Lead Plastic Dual In-Line Package [PDIP]
Narrow Body
(N-16)

Dimensions shown in inches

03-07-2014-D

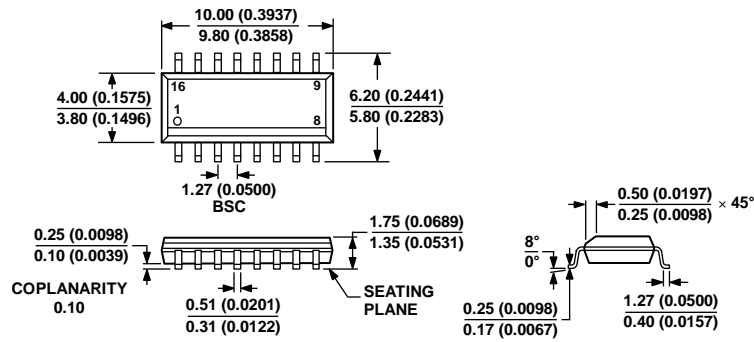

COMPLIANT TO JEDEC STANDARDS MS-012-AC

CONTROLLING DIMENSIONS ARE IN MILLIMETERS; INCH DIMENSIONS (IN PARENTHESES) ARE ROUNDED-OFF MILLIMETER EQUIVALENTS FOR REFERENCE ONLY AND ARE NOT APPROPRIATE FOR USE IN DESIGN.

Figure 12. 16-Lead Standard Small Outline Package [SOIC_N]
Narrow Body
(R-16)

Dimensions shown in millimeters and (inches)

060606-A

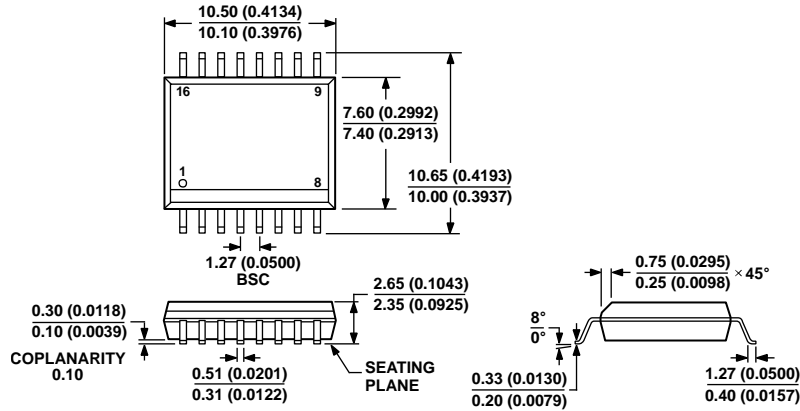

COMPLIANT TO JEDEC STANDARDS MS-013-AA
 CONTROLLING DIMENSIONS ARE IN MILLIMETERS; INCH DIMENSIONS
 (IN PARENTHESES) ARE ROUNDED-OFF MILLIMETER EQUIVALENTS FOR
 REFERENCE ONLY AND ARE NOT APPROPRIATE FOR USE IN DESIGN.

03-27-2007-B

Figure 13. 16-Lead Standard Small Outline Package [SOIC_W]
 Wide Body
 (RW-16)

Dimensions shown in millimeters and (inches)

ORDERING GUIDE

Model ¹	Temperature Range	Package Description	Package Option
ADM202JNZ	0°C to 70°C	16-Lead Plastic Dual In-Line Package [PDIP]	N-16
ADM202JRN	0°C to 70°C	16-Lead Standard Small Outline Package [SOIC_N]	R-16
ADM202JRN-REEL	0°C to 70°C	16-Lead Standard Small Outline Package [SOIC_N]	R-16
ADM202JRN-REEL7	0°C to 70°C	16-Lead Standard Small Outline Package [SOIC_N]	R-16
ADM202JRNZ	0°C to 70°C	16-Lead Standard Small Outline Package [SOIC_N]	R-16
ADM202JRNZ-REEL	0°C to 70°C	16-Lead Standard Small Outline Package [SOIC_N]	R-16
ADM202JRNZ-REEL7	0°C to 70°C	16-Lead Standard Small Outline Package [SOIC_N]	R-16
ADM202JRWZ	0°C to 70°C	16-Lead Standard Small Outline Package [SOIC_W]	RW-16
ADM202JRWZ-REEL	0°C to 70°C	16-Lead Standard Small Outline Package [SOIC_W]	RW-16

¹ Z = RoHS Compliant Part.