

FEATURES

High speed

- 120 MHz bandwidth, gain = -1
- 230 V/ μ s slew rate
- 90 ns settling time to 0.1%

Ideal for video applications

- 0.02% differential gain
- 0.04° differential phase

Low noise

- 1.7 nV/ $\sqrt{\text{Hz}}$ input voltage noise
- 1.5 pA/ $\sqrt{\text{Hz}}$ input current noise

Excellent dc precision

- 1 mV maximum input offset voltage (over temperature)
- 0.3 μ V/ $^{\circ}\text{C}$ input offset drift

Flexible operation

- Specified for ± 5 V to ± 15 V operation
- ± 3 V output swing into a 150 Ω load
- External compensation for gains 1 to 20
- 5 mA supply current

Available in tape and reel in accordance with EIA-481A standard

GENERAL DESCRIPTION

The AD829 is a low noise (1.7 nV/ $\sqrt{\text{Hz}}$), high speed op amp with custom compensation that provides the user with gains of 1 to 20 while maintaining a bandwidth >50 MHz. Its 0.04° differential phase and 0.02% differential gain performance at 3.58 MHz and 4.43 MHz, driving reverse-terminated 50 Ω or 75 Ω cables, makes it ideally suited for professional video applications. The AD829 achieves its 230 V/ μ s uncompensated slew rate and 750 MHz gain bandwidth while requiring only 5 mA of current from power supplies.

The external compensation pin of the AD829 gives it exceptional versatility. For example, compensation can be selected to optimize the bandwidth for a given load and power supply voltage. As a gain-of-2 line driver, the -3 dB bandwidth can be increased to 95 MHz at the expense of 1 dB of peaking. Its output can also be clamped at its external compensation pin.

The AD829 exhibits excellent dc performance. It offers a minimum open-loop gain of 30 V/mV into loads as low as 500 Ω , a low input voltage noise of 1.7 nV/ $\sqrt{\text{Hz}}$, and a low input offset voltage of 1 mV maximum. Common-mode rejection and power supply rejection ratios are both 120 dB.

This op amp is also useful in multichannel, high speed data conversion where its fast (90 ns to 0.1%) settling time is important. In such applications, the AD829 serves as an input buffer for 8-bit to 10-bit ADCs and as an output I/V converter for high speed DACs.

Rev. I

Information furnished by Analog Devices is believed to be accurate and reliable. However, no responsibility is assumed by Analog Devices for its use, nor for any infringements of patents or other rights of third parties that may result from its use. Specifications subject to change without notice. No license is granted by implication or otherwise under any patent or patent rights of Analog Devices. Trademarks and registered trademarks are the property of their respective owners.

CONNECTION DIAGRAM



Figure 1. 8-Lead PDIP (N), CERDIP (Q), and SOIC (R)



Figure 2. 20-Terminal LCC

Operating as a traditional voltage feedback amplifier, the AD829 provides many of the advantages that a transimpedance amplifier offer. A bandwidth >50 MHz can be maintained for a range of gains through the replacement of the external compensation capacitor. The AD829 and the transimpedance amplifier are both unity-gain stable and provide similar voltage noise performance (1.7 nV/ $\sqrt{\text{Hz}}$); however, the current noise of the AD829 (1.5 pA/ $\sqrt{\text{Hz}}$) is less than 10% of the noise of transimpedance amplifiers. The inputs of the AD829 are symmetrical.

PRODUCT HIGHLIGHTS

1. The input voltage noise of 2 nV/ $\sqrt{\text{Hz}}$, current noise of 1.5 pA/ $\sqrt{\text{Hz}}$, and 50 MHz bandwidth for gains of 1 to 20 make the AD829 an ideal preamp.
2. A differential phase error of 0.04 and a 0.02% differential gain error, at the 3.58 MHz NTSC, 4.43 MHz PAL, and SECAM color subcarrier frequencies, make the op amp an outstanding video performer for driving reverse-terminated 50 Ω and 75 Ω cables to ± 1 V (at their terminated end).
3. The AD829 can drive heavy capacitive loads.
4. Performance is fully specified for operation from ± 5 V to ± 15 V supplies.
5. The AD829 is available in PDIP, CERDIP, and small outline packages. Chips and MIL-STD-883B parts are also available. The 8-lead SOIC is available for the extended temperature range (-40°C to $+125^{\circ}\text{C}$).

AD829* Product Page Quick Links

Last Content Update: 11/01/2016

Comparable Parts

View a parametric search of comparable parts

Evaluation Kits

- Universal Evaluation Board for Single High Speed Operational Amplifiers

Documentation

Application Notes

- AN-402: Replacing Output Clamping Op Amps with Input Clamping Amps
- AN-417: Fast Rail-to-Rail Operational Amplifiers Ease Design Constraints in Low Voltage High Speed Systems
- AN-581: Biasing and Decoupling Op Amps in Single Supply Applications

Data Sheet

- AD829: High Speed, Low Noise Video Op Amp Data Sheet
- AD829: Military Data Sheet

User Guides

- UG-135: Evaluation Board for Single, High Speed Operational Amplifiers (8-Lead SOIC and Exposed Paddle)

Tools and Simulations

- Analog Filter Wizard
- Analog Photodiode Wizard
- Power Dissipation vs Die Temp
- VRMS/dBm/dBu/dBV calculators
- AD829 SPICE Macro-Model

Reference Materials

Product Selection Guide

- High Speed Amplifiers Selection Table

Tutorials

- MT-032: Ideal Voltage Feedback (VFB) Op Amp
- MT-033: Voltage Feedback Op Amp Gain and Bandwidth
- MT-047: Op Amp Noise
- MT-048: Op Amp Noise Relationships: 1/f Noise, RMS Noise, and Equivalent Noise Bandwidth
- MT-049: Op Amp Total Output Noise Calculations for Single-Pole System
- MT-052: Op Amp Noise Figure: Don't Be Misled
- MT-053: Op Amp Distortion: HD, THD, THD + N, IMD, SFDR, MTPR
- MT-056: High Speed Voltage Feedback Op Amps
- MT-058: Effects of Feedback Capacitance on VFB and CFB Op Amps
- MT-060: Choosing Between Voltage Feedback and Current Feedback Op Amps

Design Resources

- AD829 Material Declaration
- PCN-PDN Information
- Quality And Reliability
- Symbols and Footprints

Discussions

View all AD829 EngineerZone Discussions

Sample and Buy

Visit the product page to see pricing options

Technical Support

Submit a technical question or find your regional support number

* This page was dynamically generated by Analog Devices, Inc. and inserted into this data sheet. Note: Dynamic changes to the content on this page does not constitute a change to the revision number of the product data sheet. This content may be frequently modified.

TABLE OF CONTENTS

Features	1	Test Circuits.....	11
General Description	1	Theory of Operation	12
Connection Diagram	1	Externally Compensating the AD829.....	12
Product Highlights	1	Shunt Compensation	12
Revision History	2	Current Feedback Compensation	13
Specifications.....	3	Low Error Video Line Driver	15
Absolute Maximum Ratings.....	5	High Gain Video Bandwidth, 3-Op-Amp Instrumentation Amplifier	16
Thermal Characteristics	5	Outline Dimensions	17
Metallization Photo.....	5	Ordering Guide	19
ESD Caution.....	5		
Typical Performance Characteristics	6		

REVISION HISTORY

10/11—Rev. H to Rev. I

Change to Table 2	5
-------------------------	---

4/09—Rev. G to Rev. H

Changes to Features.....	1
Changes to Quiescent Current Parameter, Table 1	4
Changes to Table 2.....	5
Added Thermal Characteristics Section and Table 3	5
Updated Outline Dimensions	17
Changes to Ordering Guide	19

4/04—Rev. F to Rev. G

Added Figure 1; Renumbered Sequentially	4
Changes to Ordering Guide	5
Updated Table I.....	11
Updated Figure 15	12
Updated Figure 16	13
Updated Outline Dimensions	14

2/03—Rev. E to Rev. F

Renumbered Figures	Universal
Changes to Product Highlights	1
Changes to Specifications.....	2
Changes to Absolute Maximum Ratings.....	4
Changes to Ordering Guide	4
Updated Outline Dimensions	13

SPECIFICATIONS

$T_A = 25^\circ\text{C}$ and $V_S = \pm 15\text{ V}$ dc, unless otherwise noted.

Table 1.

Parameter	Conditions	V_S	AD829JR			AD829AR			AD829AQ/AD829S			Unit
			Min	Typ	Max	Min	Typ	Max	Min	Typ	Max	
INPUT OFFSET VOLTAGE	t_{MIN} to t_{MAX}	$\pm 5\text{ V}$, $\pm 15\text{ V}$		0.2	1		0.2	1		0.1	0.5	mV
Offset Voltage Drift		$\pm 5\text{ V}$, $\pm 15\text{ V}$			1			1			0.5	mV $\mu\text{V}/^\circ\text{C}$
INPUT BIAS CURRENT		$\pm 5\text{ V}$, $\pm 15\text{ V}$		3.3	7		3.3	7		3.3	7	μA
	t_{MIN} to t_{MAX}				8.2			9.5			9.5	μA
INPUT OFFSET CURRENT		$\pm 5\text{ V}$, $\pm 15\text{ V}$		50	500		50	500		50	500	nA
Offset Current Drift	t_{MIN} to t_{MAX}				500			500			500	nA $\text{nA}/^\circ\text{C}$
		$\pm 5\text{ V}$, $\pm 15\text{ V}$		0.5			0.5			0.5		
OPEN-LOOP GAIN	$V_O = \pm 2.5\text{ V}$, $R_L = 500\ \Omega$	$\pm 5\text{ V}$	30	65		30	65		30	65		V/mV
	$R_L = 150\ \Omega$			40			40			40		V/mV
	t_{MIN} to t_{MAX}		20			20			20			V/mV
	$V_O = \pm 10\text{ V}$, $R_L = 1\ \text{k}\Omega$	$\pm 15\text{ V}$	50	100		50	100		50	100		V/mV
	$R_L = 500\ \Omega$			85			85			85		V/mV
t_{MIN} to t_{MAX}		20			20			20			V/mV	
DYNAMIC PERFORMANCE												
Gain Bandwidth Product		$\pm 5\text{ V}$		600		600		600		600		MHz
		$\pm 15\text{ V}$		750		750		750		750		MHz
Full Power Bandwidth ^{1,2}	$V_O = 2\text{ V p-p}$, $R_L = 500\ \Omega$	$\pm 5\text{ V}$		25		25		25		25		MHz
	$V_O = 20\text{ V p-p}$, $R_L = 1\ \text{k}\Omega$	$\pm 15\text{ V}$		3.6		3.6		3.6		3.6		MHz
Slew Rate ²	$R_L = 500\ \Omega$	$\pm 5\text{ V}$		150		150		150		150		$\text{V}/\mu\text{s}$
	$R_L = 1\ \text{k}\Omega$	$\pm 15\text{ V}$		230		230		230		230		$\text{V}/\mu\text{s}$
Settling Time to 0.1%	$A_V = -19$											
	-2.5 V to $+2.5\text{ V}$	$\pm 5\text{ V}$		65		65		65		65		ns
Phase Margin ²	10 V step	$\pm 15\text{ V}$		90		90		90		90		ns
	$C_L = 10\ \text{pF}$	$\pm 15\text{ V}$										
	$R_L = 1\ \text{k}\Omega$			60		60		60		60		Degrees
DIFFERENTIAL GAIN ERROR ³	$R_L = 100\ \Omega$, $C_{\text{COMP}} = 30\ \text{pF}$	$\pm 15\text{ V}$		0.02		0.02		0.02		0.02		%
DIFFERENTIAL PHASE ERROR ³	$R_L = 100\ \Omega$, $C_{\text{COMP}} = 30\ \text{pF}$	$\pm 15\text{ V}$		0.04		0.04		0.04		0.04		Degrees
COMMON-MODE REJECTION	$V_{\text{CM}} = \pm 2.5\text{ V}$	$\pm 5\text{ V}$	100	120		100	120		100	120		dB
	$V_{\text{CM}} = \pm 12\text{ V}$	$\pm 15\text{ V}$	100	120		100	120		100	120		dB
	t_{MIN} to t_{MAX}		96			96		96		96		dB
POWER SUPPLY REJECTION	$V_S = \pm 4.5\text{ V}$ to $\pm 18\text{ V}$		98	120		98	120		98	120		dB
	t_{MIN} to t_{MAX}		94			94		94		94		dB
INPUT VOLTAGE NOISE	$f = 1\ \text{kHz}$	$\pm 15\text{ V}$		1.7	2		1.7	2		1.7	2	$\text{nV}/\sqrt{\text{Hz}}$
INPUT CURRENT NOISE	$f = 1\ \text{kHz}$	$\pm 15\text{ V}$		1.5			1.5			1.5		$\text{pA}/\sqrt{\text{Hz}}$

Parameter	Conditions	V _S	AD829JR			AD829AR			AD829AQ/AD829S			Unit	
			Min	Typ	Max	Min	Typ	Max	Min	Typ	Max		
INPUT COMMON-MODE VOLTAGE RANGE		±5 V	+4.3			+4.3			+4.3			V	
			−3.8			−3.8			−3.8			V	
		±15 V	+14.3			+14.3			+14.3			V	
			−13.8			−13.8			−13.8			V	
OUTPUT VOLTAGE SWING	R _L = 500 Ω	±5 V	±3.0	±3.6		±3.0	±3.6		±3.0	±3.6		V	
	R _L = 150 Ω	±5 V	±2.5	±3.0		±2.5	±3.0		±2.5	±3.0		V	
	R _L = 50 Ω	±5 V		±1.4			±1.4			±1.4		V	
	R _L = 1 kΩ	±15 V	±12	±13.3		±12	±13.3		±12	±13.3		V	
	R _L = 500 Ω	±15 V	±10	±12.2		±10	±12.2		±10	±12.2		V	
Short-Circuit Current		±5 V, ±15 V	32			32			32			mA	
INPUT CHARACTERISTICS													
Input Resistance (Differential)			13			13			13			kΩ	
Input Capacitance (Differential) ⁴			5			5			5			pF	
Input Capacitance (Common Mode)			1.5			1.5			1.5			pF	
CLOSED-LOOP OUTPUT RESISTANCE	A _V = +1, f = 1 kHz		2			2			2			mΩ	
POWER SUPPLY													
Operating Range			±4.5			±18			±4.5			±18	V
Quiescent Current		±5 V	5			6.5			5			6.5	mA
	t _{MIN} to t _{MAX}					8.0						8.7	mA
		±15 V	5.3			6.8			5.3			6.8	mA
		t _{MIN} to t _{MAX}				8.3						9.0	mA
TRANSISTOR COUNT	Number of transistors		46			46			46				

¹ Full power bandwidth = slew rate/2 π V_{PEAK}.

² Tested at gain = 20, C_{COMP} = 0 pF.

³ 3.58 MHz (NTSC) and 4.43 MHz (PAL and SECAM).

⁴ Differential input capacitance consists of 1.5 pF package capacitance plus 3.5 pF from the input differential pair.

ABSOLUTE MAXIMUM RATINGS

Table 2.

Parameter	Rating
Supply Voltage	±18 V
Internal Power Dissipation ¹	
8-Lead PDIP (N)	1.3 W
8-Lead SOIC (R)	0.9 W
8-Lead CERDIP (Q)	1.3 W
20-Terminal LCC (E)	0.8 W
Differential Input Voltage ²	±6 V
Output Short-Circuit Duration	Indefinite
Storage Temperature Range	
8-Lead CERDIP (Q) and 20-Terminal LCC (E)	−65°C to +150°C
8-Lead PDIP (N) and 8-Lead SOIC (R)	−65°C to +125°C
Operating Temperature Range	
AD829J	0°C to 70°C
AD829A	−40°C to +125°C
AD829S	−55°C to +125°C
Lead Temperature (Soldering, 60 sec)	300°C

¹ Maximum internal power dissipation is specified so that T_J does not exceed 150°C at an ambient temperature of 25°C.

² If the differential voltage exceeds 6 V, external series protection resistors should be added to limit the input current.

Stresses above those listed under Absolute Maximum Ratings may cause permanent damage to the device. This is a stress rating only; functional operation of the device at these or any other conditions above those indicated in the operational section of this specification is not implied. Exposure to absolute maximum rating conditions for extended periods may affect device reliability.

THERMAL CHARACTERISTICS

Table 3.

Package Type	θ _{JA}	Unit
8-Lead PDIP (N)	100 (derates at 8.7 mW/°C)	°C/W
8-Lead CERDIP (Q)	110 (derates at 8.7 mW/°C)	°C/W
20-Lead LCC (E)	77	°C/W
8-Lead SOIC (R)	125 (derates at 6 mW/°C)	°C/W

METALLIZATION PHOTO

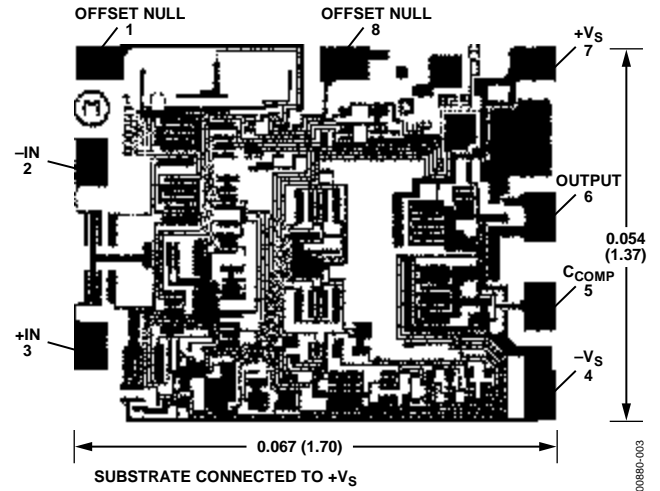

Figure 3. Metallization Photo; Contact Factory for Latest Dimensions, Dimensions Shown in Inches and (Millimeters)

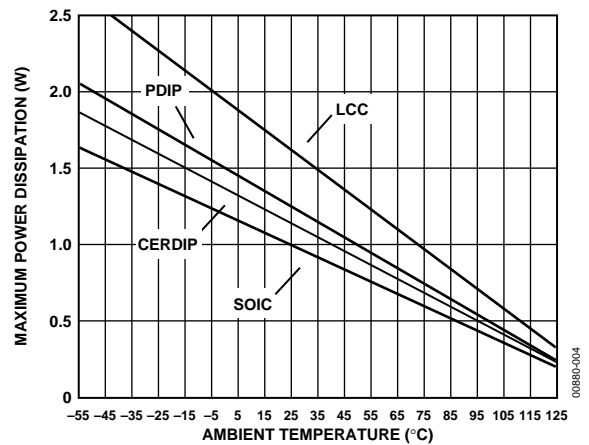

Figure 4. Maximum Power Dissipation vs. Temperature

ESD CAUTION



ESD (electrostatic discharge) sensitive device. Charged devices and circuit boards can discharge without detection. Although this product features patented or proprietary protection circuitry, damage may occur on devices subjected to high energy ESD. Therefore, proper ESD precautions should be taken to avoid performance degradation or loss of functionality.

TYPICAL PERFORMANCE CHARACTERISTICS

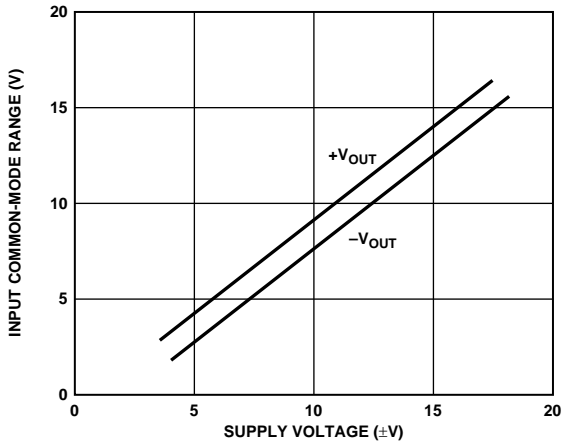

Figure 5. Input Common-Mode Range vs. Supply Voltage

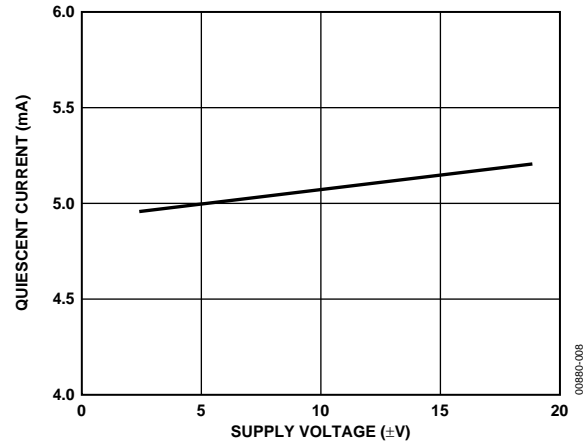

Figure 8. Quiescent Current vs. Supply Voltage

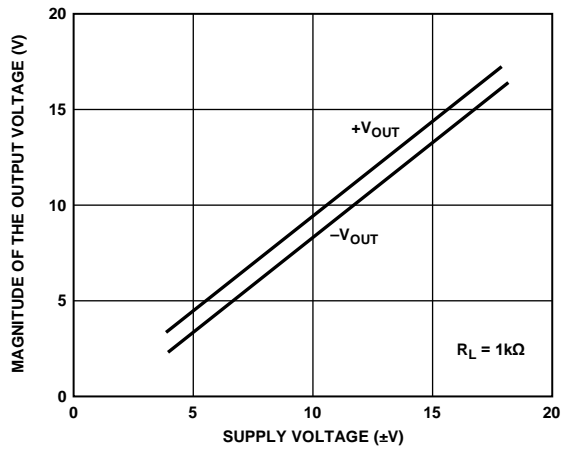

Figure 6. Output Voltage Swing vs. Supply Voltage

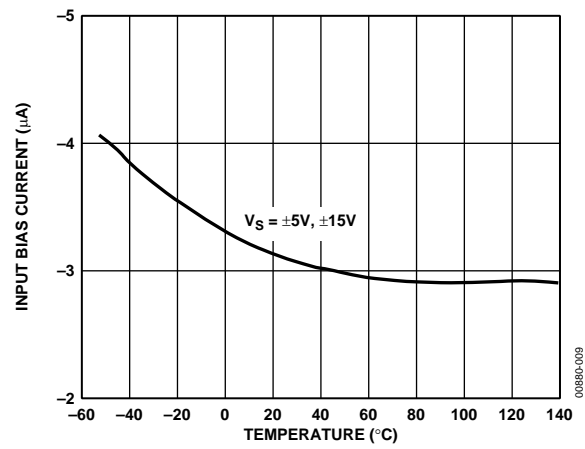

Figure 9. Input Bias Current vs. Temperature

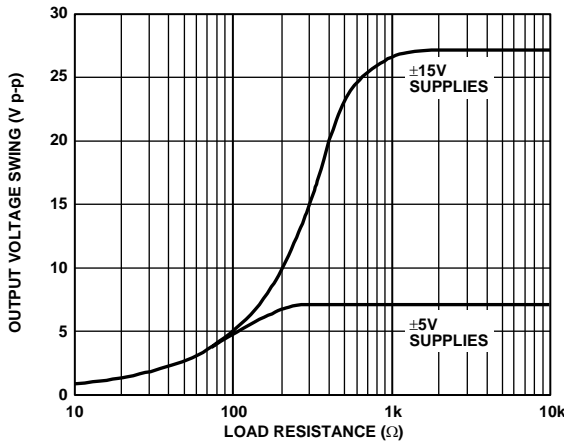

Figure 7. Output Voltage Swing vs. Resistive Load

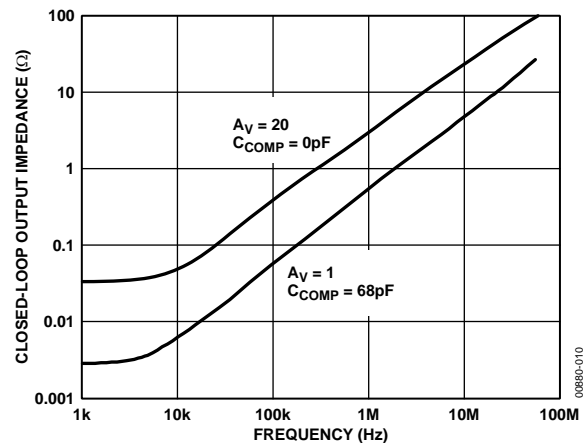

Figure 10. Closed-Loop Output Impedance vs. Frequency

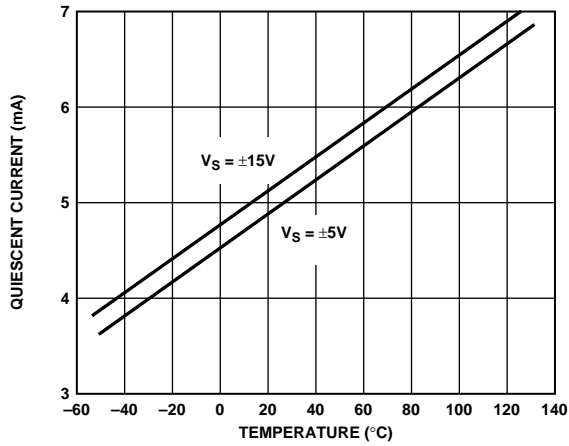

Figure 11. Quiescent Current vs. Temperature

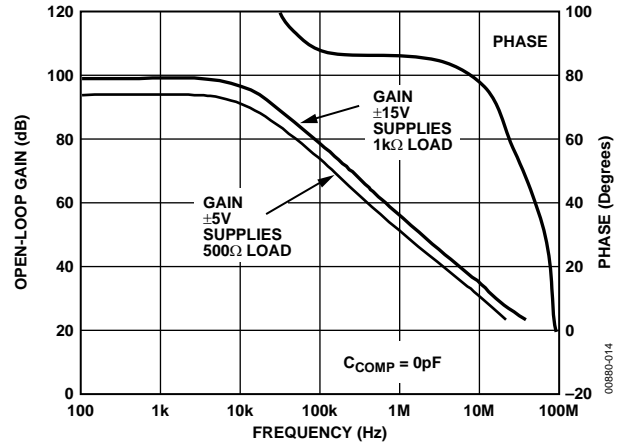

Figure 14. Open-Loop Gain and Phase vs. Frequency

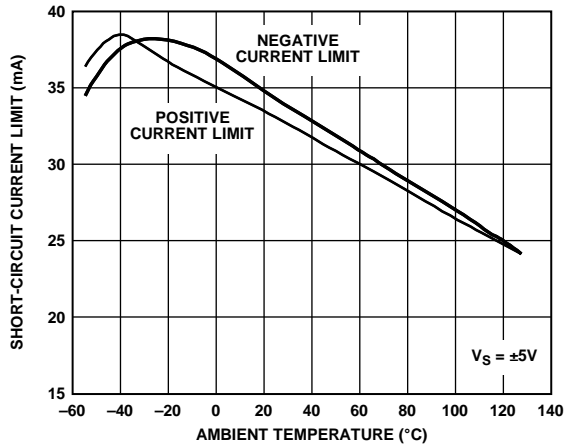

Figure 12. Short-Circuit Current Limit vs. Ambient Temperature

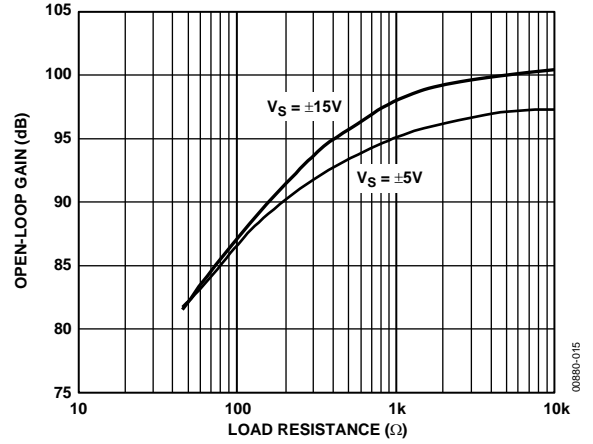

Figure 15. Open-Loop Gain vs. Resistive Load

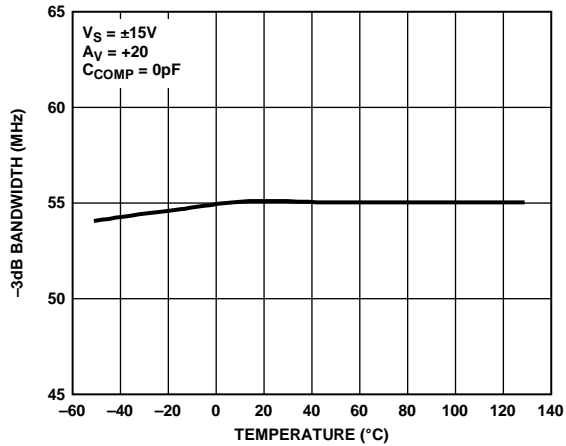

Figure 13. -3 dB Bandwidth vs. Temperature

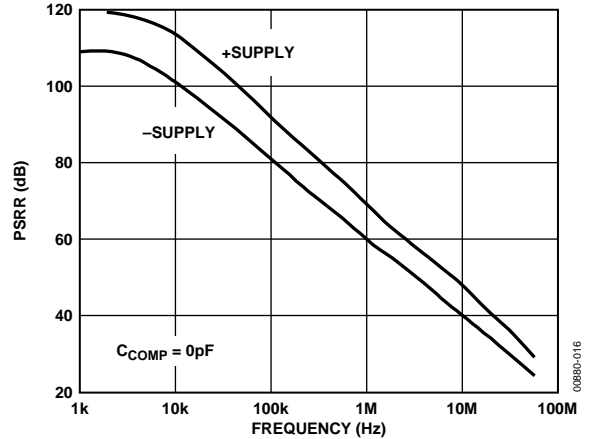

Figure 16. Power Supply Rejection Ratio (PSRR) vs. Frequency

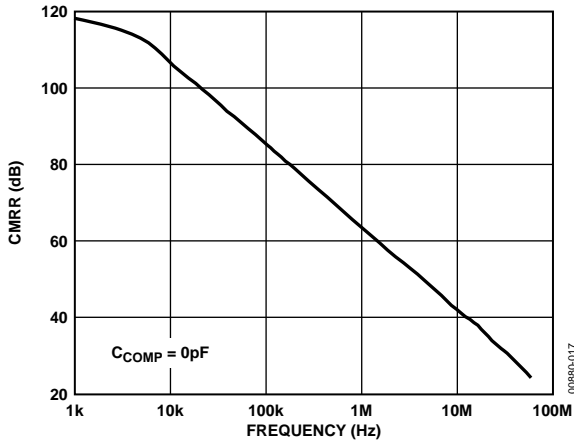

Figure 17. Common-Mode Rejection Ratio (CMRR) vs. Frequency

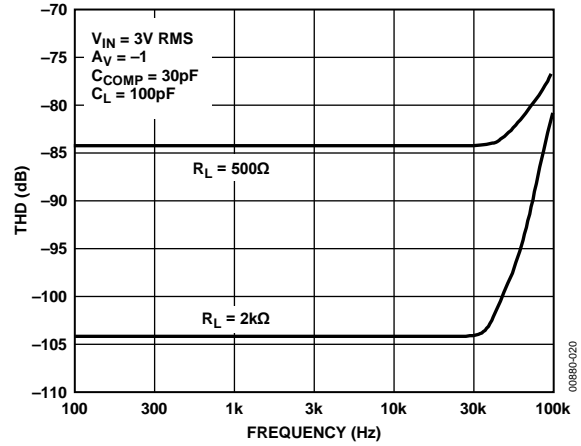

Figure 20. Total Harmonic Distortion (THD) vs. Frequency

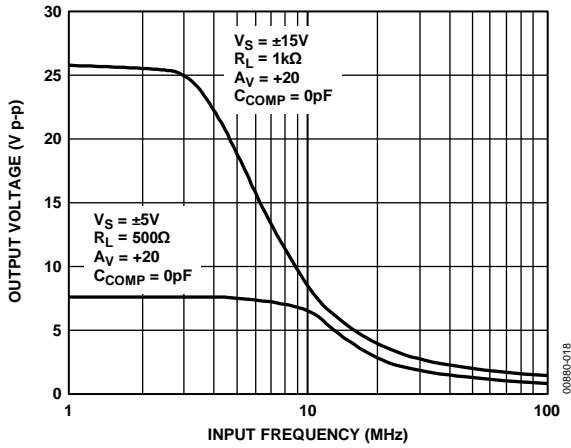

Figure 18. Large Signal Frequency Response

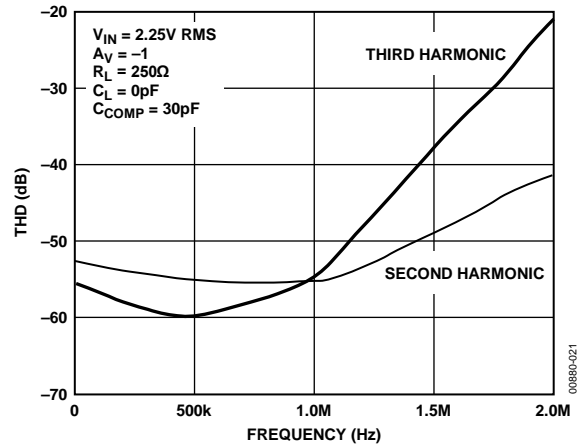

Figure 21. Second and Third THD vs. Frequency

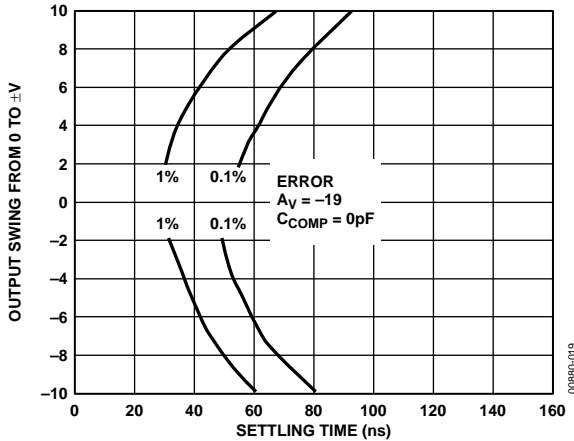

Figure 19. Output Swing and Error vs. Settling Time

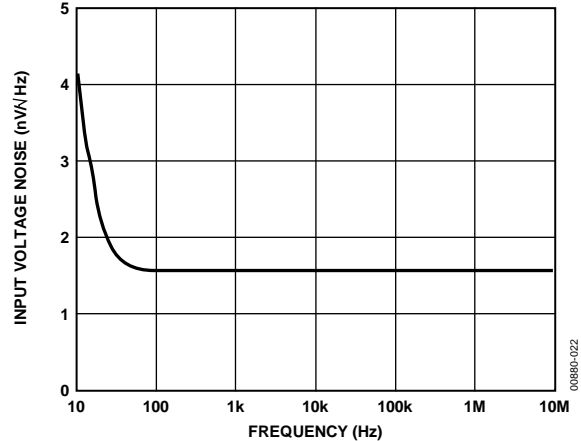

Figure 22. Input Voltage Noise Spectral Density

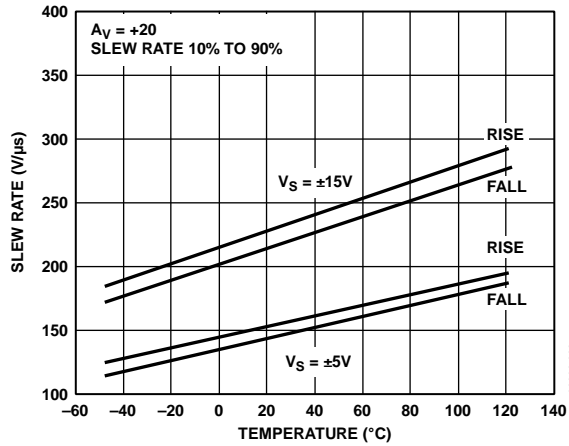

Figure 23. Slew Rate vs. Temperature

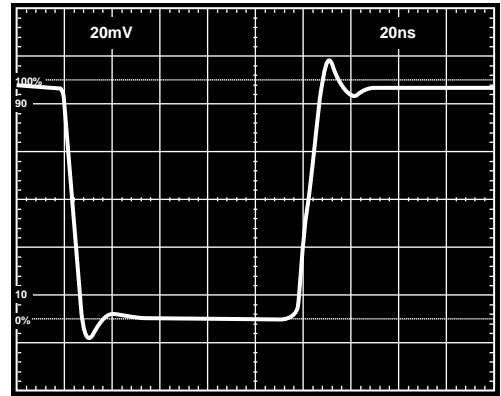

Figure 26. Gain-of-2 Follower Small Signal Pulse Response (See Figure 32)

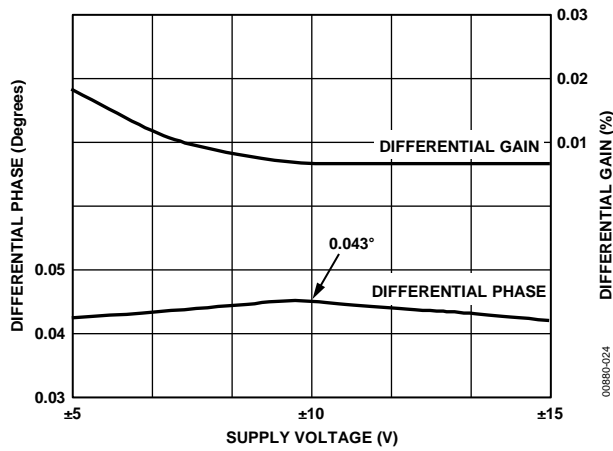

Figure 24. Differential Phase and Gain vs. Supply Voltage

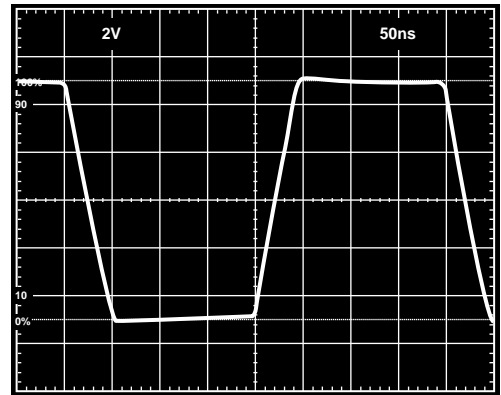

Figure 27. Gain-of-20 Follower Large Signal Pulse Response (See Figure 33)

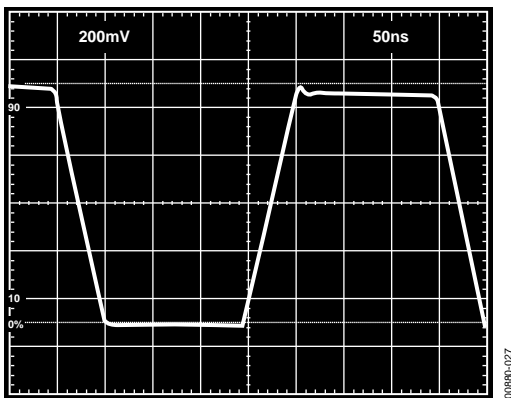

Figure 25. Gain-to-2 Follower Large Signal Pulse Response (See Figure 32)

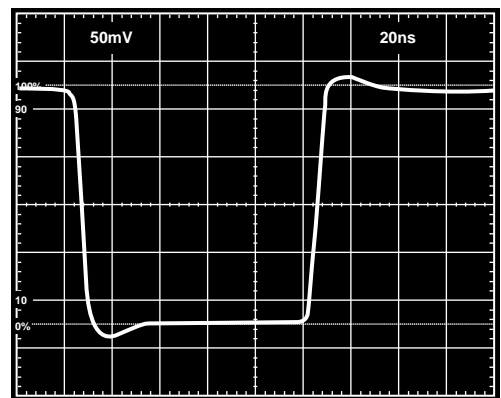

Figure 28. Gain-of-20 Follower Small Signal Pulse Response (See Figure 33)

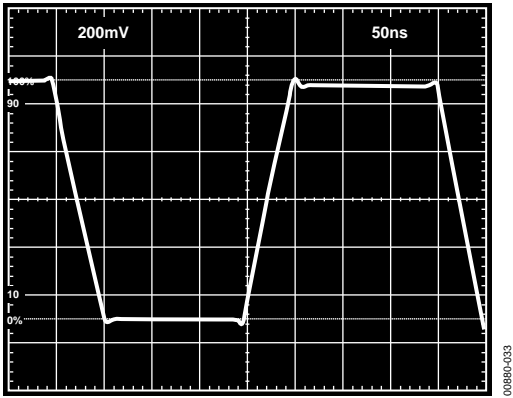

Figure 29. Unity-Gain Inverter Large Signal Pulse Response (See Figure 34)

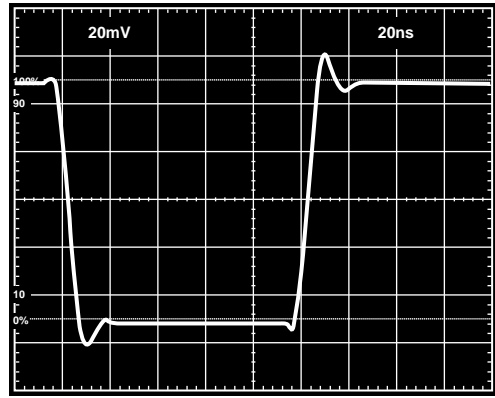

Figure 30. Unity-Gain Inverter Small Signal Pulse Response (See Figure 34)

THEORY OF OPERATION

The AD829 is fabricated on the Analog Devices, Inc., proprietary complementary bipolar (CB) process, which provides PNP and NPN transistors with similar f_{TS} of 600 MHz. As shown in Figure 35, the AD829 input stage consists of an NPN differential pair in which each transistor operates at a 600 μ A collector current. This gives the input devices a high transconductance, which in turn gives the AD829 a low noise figure of 2 nV/ $\sqrt{\text{Hz}}$ at 1 kHz.

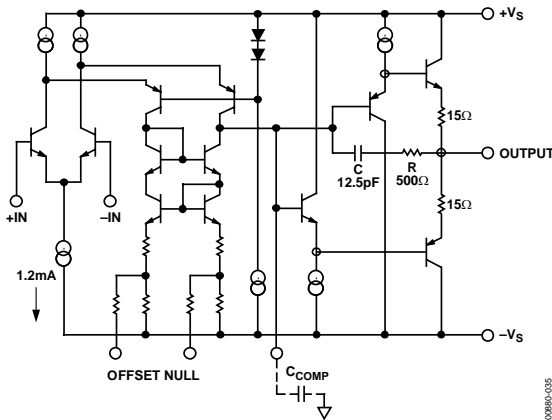

Figure 35. Simplified Schematic

The input stage drives a folded cascode that consists of a fast pair of PNP transistors. These PNPs drive a current mirror that provides a differential-input-to-single-ended-output conversion. The high speed PNPs are also used in the current-amplifying output stage, which provides a high current gain of 40,000. Even under heavy loading conditions, the high f_{TS} of the NPN and PNPs, produced using the CB process, permit cascading two stages of emitter followers while maintaining 60 phase margin at closed-loop bandwidths greater than 50 MHz.

Two stages of complementary emitter followers also effectively buffer the high impedance compensation node (at the C_{COMP} pin) from the output so that the AD829 can maintain a high dc open-loop gain, even into low load impedances (92 dB into a 150 Ω load and 100 dB into a 1 k Ω load). Laser trimming and PTAT biasing ensure low offset voltage and low offset voltage drift, enabling the user to eliminate ac coupling in many applications.

For added flexibility, the AD829 provides access to the internal frequency compensation node. This allows users to customize the frequency response characteristics for a particular application.

Unity-gain stability requires a compensation capacitance of 68 pF (Pin 5 to ground), which yields a small signal bandwidth of 66 MHz and slew rate of 16 V/ μ s. The slew rate and gain bandwidth product varies inversely with compensation capacitance. Table 4 and Figure 37 show the optimum compensation capacitance and the resulting slew rate for a desired noise gain.

For gains between 1 and 20, choose C_{COMP} to keep the small signal bandwidth relatively constant. The minimum gain that will still provide stability depends on the value of the external compensation capacitance.

An RC network in the output stage (see Figure 35) completely removes the effect of capacitive loading when the amplifier compensates for closed-loop gains of 10 or higher. At low frequencies, and with low capacitive loads, the gain from the compensation node to the output is very close to unity. In this case, C is bootstrapped and does not contribute to the compensation capacitance of the device. As the capacitive load increases, a pole forms with the output impedance of the output stage, which reduces the gain, and subsequently, C is incompletely bootstrapped. Therefore, some fraction of C contributes to the compensation capacitance, and the unity-gain bandwidth falls. As the load capacitance is further increased, the bandwidth continues to fall, and the amplifier remains stable.

EXTERNALLY COMPENSATING THE AD829

The AD829 is stable with no external compensation for noise gains greater than 20. For lower gains, two different methods of frequency compensating the amplifier can be used to achieve closed-loop stability: shunt and current feedback compensation.

SHUNT COMPENSATION

Figure 36 and Figure 37 show that shunt compensation has an external compensation capacitor, C_{COMP} , connected between the compensation pin and ground. This external capacitor is tied in parallel with approximately 3 pF of internal capacitance at the compensation node. In addition, a small capacitance, C_{LEAD} , in parallel with resistor R2, compensates for the capacitance at the inverting input of the amplifier.

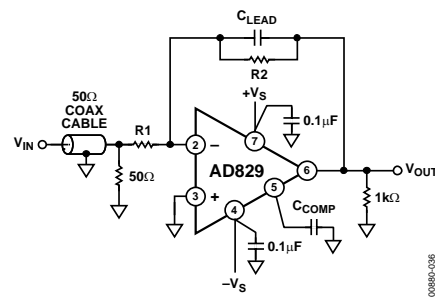

Figure 36. Inverting Amplifier Connection Using External Shunt Compensation

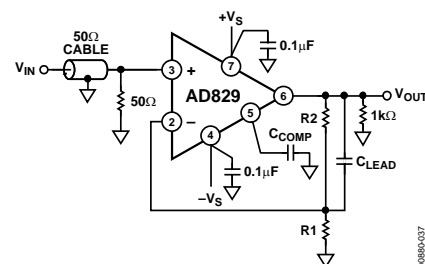

Figure 37. Noninverting Amplifier Connection Using External Shunt Compensation

Table 4 gives the recommended C_{COMP} and C_{LEAD} values, as well as the corresponding slew rates and bandwidth. The capacitor values were selected to provide a small signal frequency response with <1 dB of peaking and <10% overshoot. For Table 4, ± 15 V

supply voltages should be used. Figure 38 is a graphical extension of Table 4, which shows the slew rate/gain trade-off for lower closed-loop gains, when using the shunt compensation scheme.

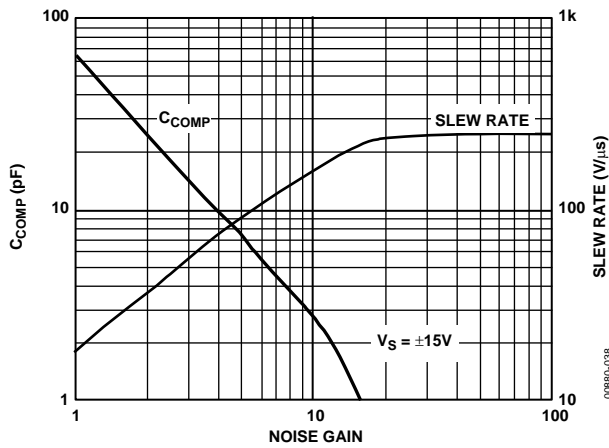

Figure 38. Value of C_{COMP} and Slew Rate vs. Noise Gain

CURRENT FEEDBACK COMPENSATION

Bipolar, nondegenerated, single-pole, and internally compensated amplifiers have their bandwidths defined as

$$f_T = \frac{1}{2\pi r_e C_{COMP}} = \frac{I}{2\pi \frac{kT}{q} C_{COMP}}$$

where:

f_T is the unity-gain bandwidth of the amplifier.

I is the collector current of the input transistor.

C_{COMP} is the compensation capacitance.

r_e is the inverse of the transconductance of the input transistors. kT/q approximately equals 26 mV at 27°C.

Because both f_T and slew rate are functions of the same variables, the dynamic behavior of an amplifier is limited. Because

$$Slew Rate = \frac{2I}{C_{COMP}}$$

then

$$\frac{Slew Rate}{f_T} = 4\pi \frac{kT}{q}$$

This shows that the slew rate is only 0.314 V/μs for every megahertz of bandwidth. The only way to increase the slew rate is to increase the f_T , and that is difficult because of process limitations. Unfortunately, an amplifier with a bandwidth of 10 MHz can only slew at 3.1 V/μs, which is barely enough to provide a full power bandwidth of 50 kHz.

The AD829 is especially suited to a form of current feedback compensation that allows for the enhancement of both the full power bandwidth and the slew rate of the amplifier. The voltage gain from the inverting input pin to the compensation pin is large; therefore, if a capacitance is inserted between these pins, the bandwidth of the amplifier becomes a function of its feedback resistor and the capacitance. The slew rate of the amplifier is now a function of its internal bias ($2I$) and the compensation capacitance.

Table 4. Component Selection for Shunt Compensation

Follower Gain	Inverter Gain	R1 (Ω)	R2 (Ω)	C _{LEAD} (pF)	C _{COMP} (pF)	Slew Rate (V/μs)	-3 dB Small Signal Bandwidth (MHz)
1		Open	100	0	68	16	66
2	-1	1 k	1 k	5	25	38	71
5	-4	511	2.0 k	1	7	90	76
10	-9	226	2.05 k	0	3	130	65
20	-19	105	2 k	0	0	230	55
25	-24	105	2.49 k	0	0	230	39
100	-99	20	2 k	0	0	230	7.5

Because the closed-loop bandwidth is a function of R_F and C_{COMP} (see Figure 39), it is independent of the amplifier closed-loop gain, as shown in Figure 41. To preserve stability, the time constant of R_F and C_{COMP} needs to provide a bandwidth of <65 MHz. For example, with $C_{COMP} = 15$ pF and $R_F = 1$ k Ω , the small signal bandwidth of the AD829 is 10 MHz. Figure 40 shows that the slew rate is in excess of 60 V/ μ s. As shown in Figure 41, the closed-loop bandwidth is constant for gains of -1 to -4 ; this is a property of the current feedback amplifiers.

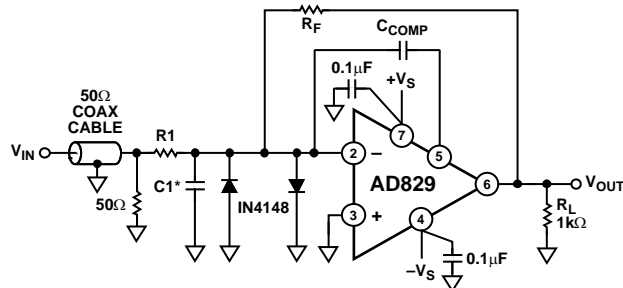

*RECOMMENDED VALUE OF C_{COMP} FOR $C1$

<7 pF	0 pF
≥ 7 pF	15 pF

C_{COMP} SHOULD NEVER EXCEED 15 pF FOR THIS CONNECTION

Figure 39. Inverting Amplifier Connection Using Current Feedback Compensation

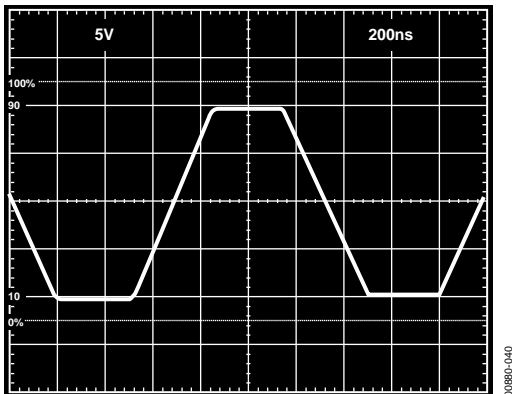

Figure 40. Large Signal Pulse Response of Inverting Amplifier Using Current Feedback Compensation, $C_{COMP} = 15$ pF, $C1 = 15$ pF, $R_F = 1$ k Ω , $R1 = 1$ k Ω

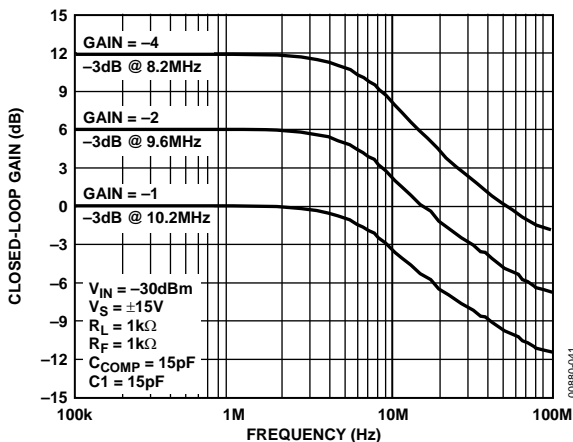

Figure 41. Closed-Loop Gain vs. Frequency for the Circuit of Figure 38

Figure 42 is an oscilloscope photo of the pulse response of a unity-gain inverter that has been configured to provide a small signal bandwidth of 53 MHz and a subsequent slew rate of 180 V/ μ s; $R_F = 3$ k Ω and $C_{COMP} = 1$ pF. Figure 43 shows the excellent pulse response as a unity-gain inverter, this using component values of $R_F = 1$ k Ω and $C_{COMP} = 4$ pF.

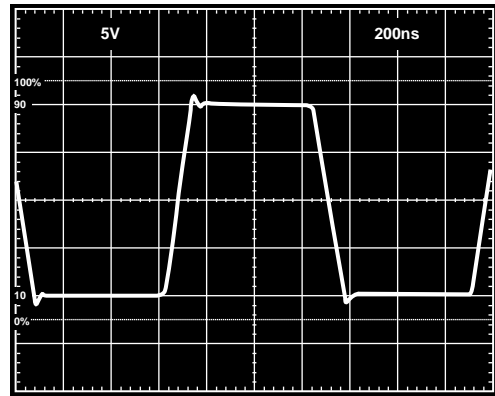

Figure 42. Large Signal Pulse Response of the Inverting Amplifier Using Current Feedback Compensation, $C_{COMP} = 1$ pF, $R_F = 3$ k Ω , $R1 = 3$ k Ω

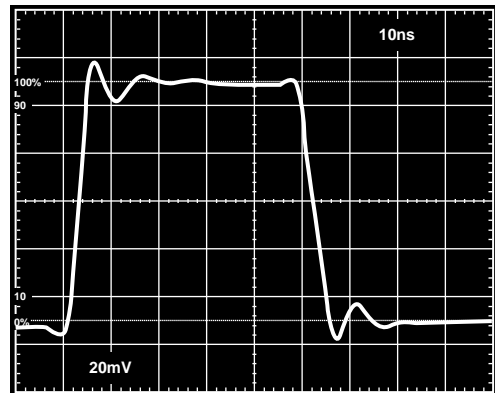

Figure 43. Small Signal Pulse Response of Inverting Amplifier Using Current Feedback Compensation, $C_{COMP} = 4$ pF, $R_F = 1$ k Ω , $R1 = 1$ k Ω

Figure 44 and Figure 45 show the closed-loop frequency response of the AD829 for different closed-loop gains and different supply voltages.

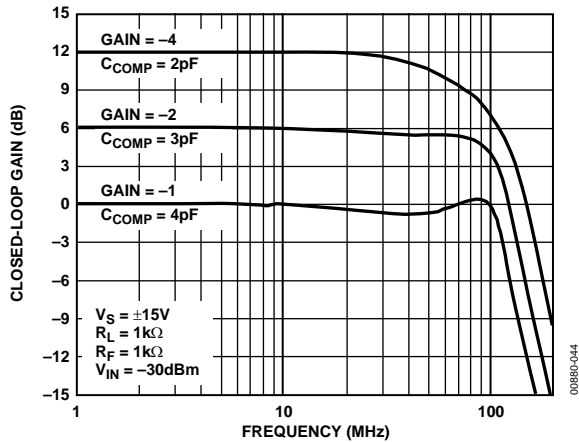

Figure 44. Closed-Loop Frequency Response for the Inverting Amplifier Using Current Feedback Compensation

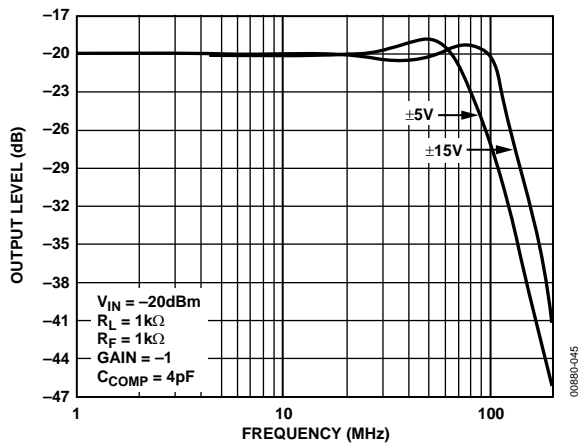

Figure 45. Closed-Loop Frequency Response vs. Supply for the Inverting Amplifier Using Current Feedback Compensation

When a noninverting amplifier configuration using a current feedback compensation is needed, the circuit shown in Figure 46 is recommended. This circuit provides a slew rate twice that of the shunt compensated noninverting amplifier of Figure 47 at the expense of gain flatness. Nonetheless, this circuit delivers 95 MHz bandwidth with 1 dB flatness into a back-terminated cable, with a differential gain error of only 0.01% and a differential phase error of only 0.015 at 4.43 MHz.

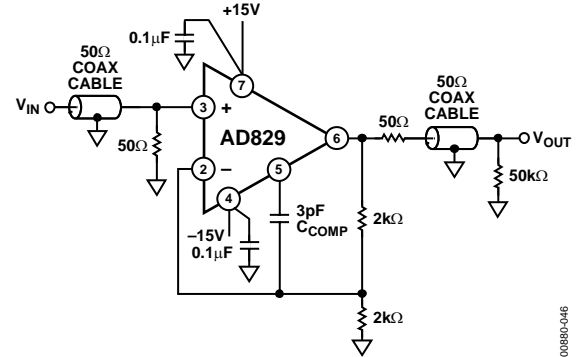

Figure 46. Noninverting Amplifier Connection Using Current Feedback Compensation

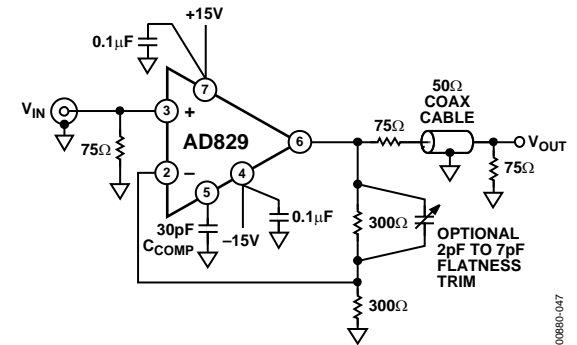

Figure 47. Video Line Driver with a Flatness over Frequency Adjustment

LOW ERROR VIDEO LINE DRIVER

The buffer circuit shown in Figure 47 drives a back-terminated 75 Ω video line to standard video levels (1 V p-p), with 0.1 dB gain flatness to 30 MHz and with only 0.04° and 0.02% differential phase and gain at the 4.43 MHz PAL color subcarrier frequency. This level of performance, which meets the requirements for high definition video displays and test equipment, is achieved using only 5 mA quiescent current.

HIGH GAIN VIDEO BANDWIDTH, 3-OP-AMP INSTRUMENTATION AMPLIFIER

Figure 48 shows a 3-op-amp instrumentation amplifier circuit that provides a gain of 100 at video bandwidths. At a circuit gain of 100, the small signal bandwidth equals 18 MHz into a FET probe. Small signal bandwidth equals 6.6 MHz with a 50 Ω load. The 0.1% settling time is 300 ns.

The input amplifiers operate at a gain of 20, while the output op amp runs at a gain of 5. In this circuit, the main bandwidth limitation is the gain/bandwidth product of the output amplifier. Extra care should be taken while breadboarding this circuit because even a couple of extra picofarads of stray capacitance at the compensation pins of A1 and A2 will degrade circuit bandwidth.

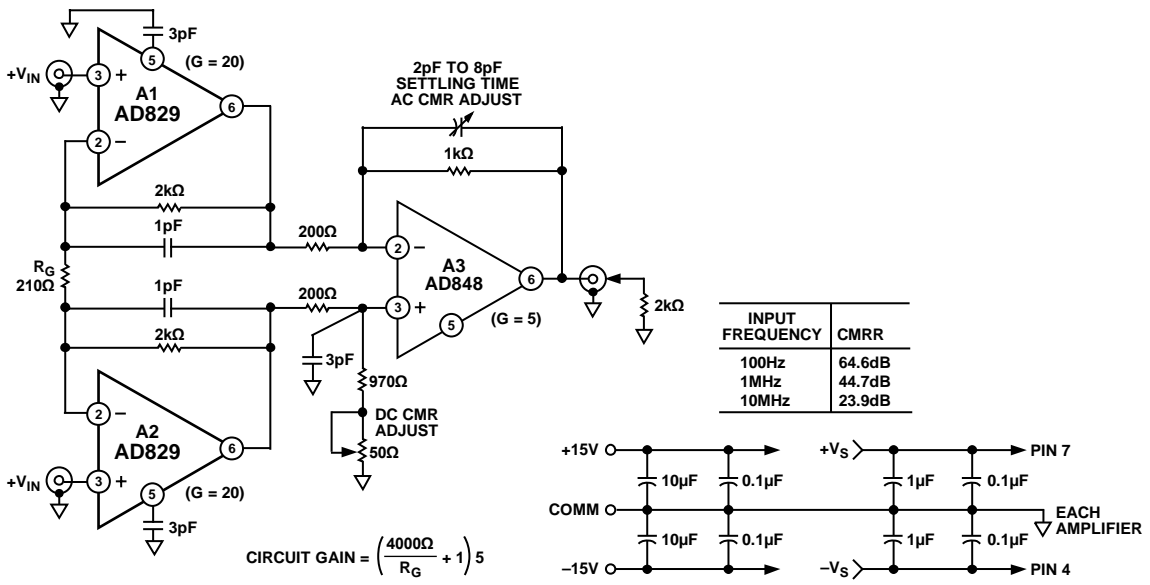
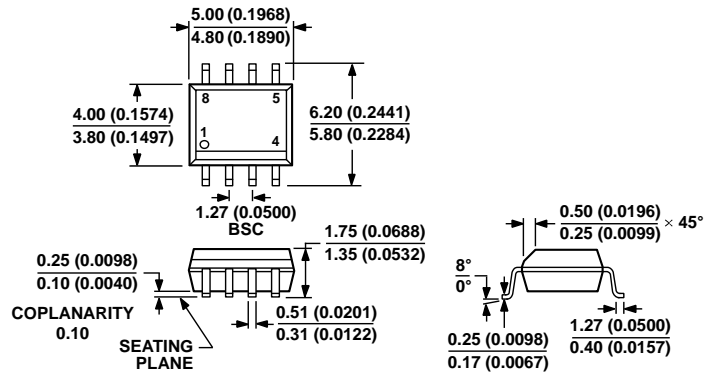

Figure 48. High Gain Video Bandwidth, 3-Op-Amp In-Amp Circuit

OUTLINE DIMENSIONS



COMPLIANT TO JEDEC STANDARDS MS-012-AA
 CONTROLLING DIMENSIONS ARE IN MILLIMETERS; INCH DIMENSIONS (IN PARENTHESES) ARE ROUNDED-OFF MILLIMETER EQUIVALENTS FOR REFERENCE ONLY AND ARE NOT APPROPRIATE FOR USE IN DESIGN.

Figure 49. 8-Lead Standard Small Outline Package [SOIC_N] Narrow Body (R-8)
 Dimensions shown in millimeters and (inches)

012407-A

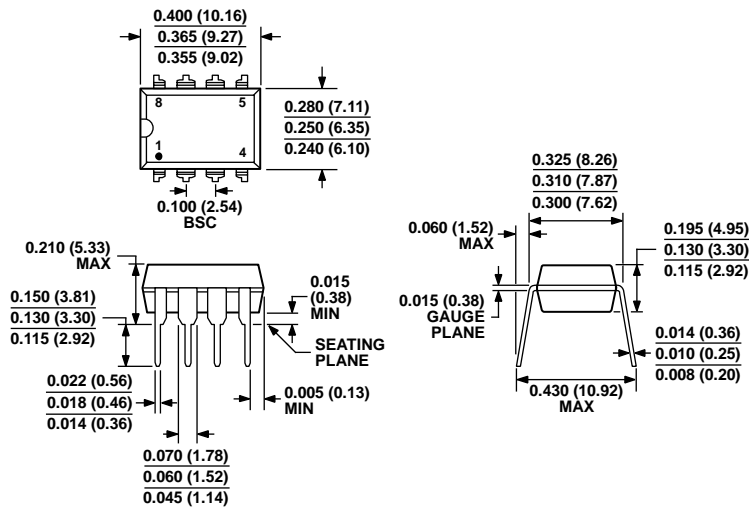

COMPLIANT TO JEDEC STANDARDS MS-001
 CONTROLLING DIMENSIONS ARE IN INCHES; MILLIMETER DIMENSIONS (IN PARENTHESES) ARE ROUNDED-OFF INCH EQUIVALENTS FOR REFERENCE ONLY AND ARE NOT APPROPRIATE FOR USE IN DESIGN. CORNER LEADS MAY BE CONFIGURED AS WHOLE OR HALF LEADS.

Figure 50. 8-Lead Plastic Dual In-Line Package [PDIP] Narrow Body (N-8)
 Dimensions shown in inches and (millimeters)

070606-A

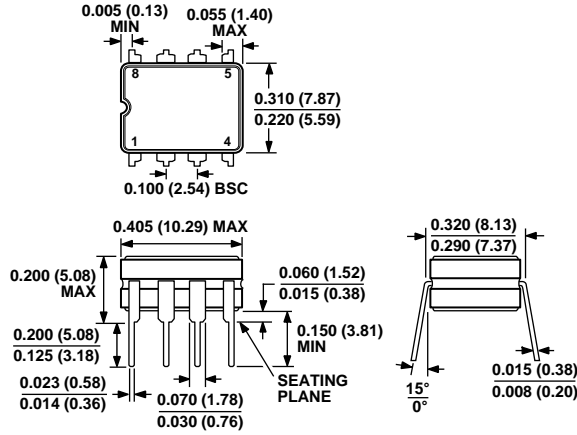

CONTROLLING DIMENSIONS ARE IN INCHES; MILLIMETER DIMENSIONS (IN PARENTHESES) ARE ROUNDED-OFF INCH EQUIVALENTS FOR REFERENCE ONLY AND ARE NOT APPROPRIATE FOR USE IN DESIGN.

Figure 51. 8-Lead Ceramic Dual In-Line [CERDIP] (Q-8)

Dimensions shown in inches and (millimeters)

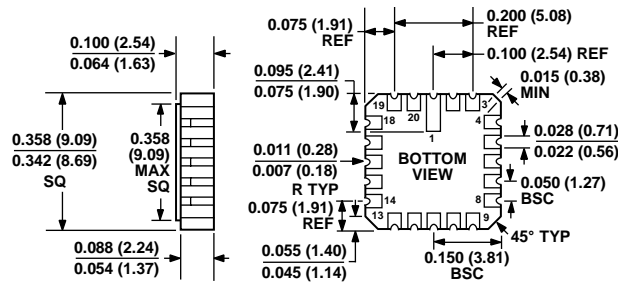

CONTROLLING DIMENSIONS ARE IN INCHES; MILLIMETER DIMENSIONS (IN PARENTHESES) ARE ROUNDED-OFF INCH EQUIVALENTS FOR REFERENCE ONLY AND ARE NOT APPROPRIATE FOR USE IN DESIGN.

Figure 52. 20-Terminal Ceramic Leadless Chip Carrier [LCC] (E-20-1)

Dimensions shown in inches and (millimeters)

022106-A

ORDERING GUIDE

Model ¹	Temperature Range	Package Description	Package Option
AD829AR	−40°C to +125°C	8-Lead SOIC_N	R-8
AD829AR-REEL	−40°C to +125°C	8-Lead SOIC_N	R-8
AD829AR-REEL7	−40°C to +125°C	8-Lead SOIC_N	R-8
AD829ARZ	−40°C to +125°C	8-Lead SOIC_N	R-8
AD829ARZ-REEL	−40°C to +125°C	8-Lead SOIC_N	R-8
AD829ARZ-REEL7	−40°C to +125°C	8-Lead SOIC_N	R-8
AD829JN	0°C to 70°C	8-Lead PDIP	N-8
AD829JNZ	0°C to 70°C	8-Lead PDIP	N-8
AD829JR	0°C to 70°C	8-Lead SOIC_N	R-8
AD829JR-REEL	0°C to 70°C	8-Lead SOIC_N	R-8
AD829JR-REEL7	0°C to 70°C	8-Lead SOIC_N	R-8
AD829JRZ	0°C to 70°C	8-Lead SOIC_N	R-8
AD829JRZ-REEL	0°C to 70°C	8-Lead SOIC_N	R-8
AD829JRZ-REEL7	0°C to 70°C	8-Lead SOIC_N	R-8
AD829AQ	−40°C to +125°C	8-Lead Cerdip	Q-8
AD829SQ	−55°C to +125°C	8-Lead Cerdip	Q-8
AD829SQ/883B	−55°C to +125°C	8-Lead Cerdip	Q-8
5962-9312901MPA	−55°C to +125°C	8-Lead Cerdip	Q-8
AD829SE/883B	−55°C to +125°C	20-Lead LCC	E-20-1
5962-9312901M2A	−55°C to +125°C	20-Lead LCC	E-20-1
AD829JCHIPS		Die	
AD829SCHIPS		Die	
AD829AR-EBZ		Evaluation Board	

¹ Z = RoHS Compliant Part.

NOTES