

## FEATURES

- Low  $R_{DS(on)}$  of 40 m $\Omega$
- Wide input voltage range: 2.3 V to 13.2 V
- 2 A continuous operating current,  $T_J = <85^\circ\text{C}$
- 1.2 V logic compatible enable input
- Low 15  $\mu\text{A}$  quiescent current,  $V_{IN} = 3.3\text{ V}$
- Low 19  $\mu\text{A}$  quiescent current,  $V_{IN} = 6.5\text{ V}$
- Ultralow shutdown current: 2.0  $\mu\text{A}$  at  $V_{IN} = 6.5\text{ V}$
- Ultrasmall 1.0 mm  $\times$  1.5 mm, 6-ball, 0.5 mm pitch WLCSP

## APPLICATIONS

- Mobile phones
- Digital cameras and audio devices
- Portable and battery-powered equipment

## GENERAL DESCRIPTION

The **ADP1290** is a high-side load switch designed for operation between 2.3 V and 13.2 V. This load switch provides power domain isolation, helping to extend battery operation. The device contains a low on-resistance, N-channel MOSFET that supports more than 2 A of continuous current and minimizes power loss. In addition,  $R_{DS(on)}$  is constant independent of the  $V_{IN}$  voltage. The low 15  $\mu\text{A}$  quiescent current and ultralow shutdown current of 20  $\mu\text{A}$  make the **ADP1290** ideal for battery-operated portable equipment. The built-in level shifter for enable logic makes the **ADP1290** compatible with many processors and general-purpose input/output (GPIO) controllers.

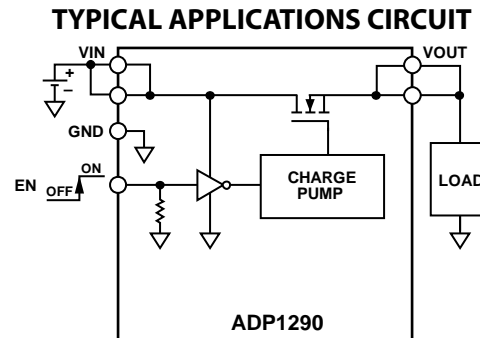

Figure 1.

In addition to operating performance, the **ADP1290** occupies minimal printed circuit board (PCB) space with an area of less than 1.5 mm<sup>2</sup> and a height of 0.60 mm.

The **ADP1290** is available in an ultrasmall, 1 mm  $\times$  1.5 mm, 6-ball, 0.5 mm pitch WLCSP.

# ADP1290\* Product Page Quick Links

Last Content Update: 11/01/2016

---

## [Comparable Parts](#)

View a parametric search of comparable parts

## [Evaluation Kits](#)

- [ADP1290 Evaluation Board](#)

## [Documentation](#)

### **Data Sheet**

- [ADP1290: 12 V, 2 A Logic Controlled High-Side Power Switch Data Sheet](#)

## [Design Resources](#)

- [ADP1290 Material Declaration](#)
- [PCN-PDN Information](#)
- [Quality And Reliability](#)
- [Symbols and Footprints](#)

## [Discussions](#)

View all ADP1290 EngineerZone Discussions

## [Sample and Buy](#)

Visit the product page to see pricing options

## [Technical Support](#)

Submit a technical question or find your regional support number

---

**TABLE OF CONTENTS**

Features .....	1	Theory of Operation .....	9
Applications.....	1	Applications Information .....	10
Typical Applications Circuit.....	1	Capacitor Selection .....	10
General Description .....	1	Ground Current.....	10
Revision History .....	2	Enable Feature .....	10
Specifications.....	3	Timing .....	11
Timing Diagram .....	3	Current and Thermal Overload Precautions.....	11
Absolute Maximum Ratings.....	4	Thermal Considerations.....	11
Thermal Resistance .....	4	Outline Dimensions .....	12
ESD Caution.....	4	Ordering Guide .....	12
Pin Configuration and Function Descriptions.....	5		
Typical Performance Characteristics .....	6		

**REVISION HISTORY**

**12/14—Revision 0: Initial Version**

## SPECIFICATIONS

$V_{IN} = 6.5\text{ V}$ , enable input voltage ( $V_{EN} = V_{IN}$ ),  $I_{OUT} = 2\text{ A}$ ,  $T_A = 25^\circ\text{C}$ ,  $T_J = -40^\circ\text{C}$  to  $+105^\circ\text{C}$  for minimum/maximum specifications, unless otherwise noted.

Table 1.

Parameter	Symbol	Test Conditions/Comments	Min	Typ	Max	Unit
INPUT VOLTAGE RANGE	$V_{IN}$		2.3		13.2	V
EN INPUT		$V_{IN} = 2.3\text{ V}$ to $13.2\text{ V}$				
EN Input	$V_{IH}$		1.0			V
	$V_{IL}$				0.4	V
EN Input Pull-Down Current	$I_{EN}$		15		1000	nA
CURRENT						
Ground (Quiescent) Current	$I_{GND}$	$V_{IN} = 2.3\text{ V}$		10	30	$\mu\text{A}$
		$V_{IN} = 3.3\text{ V}$		15	45	$\mu\text{A}$
		$V_{IN} = 6.5\text{ V}$		19	45	$\mu\text{A}$
		$V_{IN} = 13.2\text{ V}$		20	45	$\mu\text{A}$
Shutdown Current	$I_{OFF}$	$V_{EN} = 0\text{ V}$ , $V_{IN} = 6.5\text{ V}$ , output = high impedance			2.0	$\mu\text{A}$
		$V_{EN} = 0\text{ V}$ , output voltage ( $V_{OUT}$ ) = $0\text{ V}$ , $V_{IN} = 2.3\text{ V}$ to $13.2\text{ V}$			4.0	$\mu\text{A}$
Continuous Operating Current	$I_{OUT}$	$V_{IN} = 2.3\text{ V}$ to $13.2\text{ V}$ , $T_J < 85^\circ\text{C}$	2			A
VIN TO VOUT RESISTANCE	$R_{DS(on)}$					
		$V_{IN} = 2.3\text{ V}$		40	70	$\text{m}\Omega$
		$V_{IN} = 3.3\text{ V}$		40	70	$\text{m}\Omega$
		$V_{IN} = 6.5\text{ V}$		40	70	$\text{m}\Omega$
		$V_{IN} = 13.2\text{ V}$		40	70	$\text{m}\Omega$
$V_{OUT}$ TURN ON		See Figure 2				
Turn On Delay Time	$t_{ON\_DLY}$	$V_{IN} = 5.5\text{ V}$ , $C_{LOAD} = 10\text{ }\mu\text{F}$		250		$\mu\text{s}$
Turn On Rise Time	$t_{ON\_RISE}$	$V_{IN} = 5.5\text{ V}$ , $C_{LOAD} = 10\text{ }\mu\text{F}$		350		$\mu\text{s}$
Turn On Time	$t_{ON}$	Turn on delay time + turn on rise time		600	2000	$\mu\text{s}$
$V_{OUT}$ TURN OFF		See Figure 2				
Turn Off Delay Time	$t_{OFF\_DLY}$	$V_{IN} = 5.5\text{ V}$ , $C_{LOAD} = 10\text{ }\mu\text{F}$ , $I_{OUT} = 20\text{ mA}$		125		$\mu\text{s}$
Turn Off Fall Time	$t_{OFF\_FALL}$	$V_{IN} = 5.5\text{ V}$ , $C_{LOAD} = 10\text{ }\mu\text{F}$ , $I_{OUT} = 20\text{ mA}$		2000		$\mu\text{s}$
Turn Off Time	$t_{OFF}$	Turn off delay time + turn off fall time		2125		$\mu\text{s}$
SOURCE DRAIN BODY DIODE						
Diode Forward Current	$I_D$	$V_{IN} = 0\text{ V}$ , pulse width = $70\text{ }\mu\text{s}$ , duty cycle $< 1\%$ , $V_{OUT} = 0.9\text{ V}$	4		6	A

## TIMING DIAGRAM

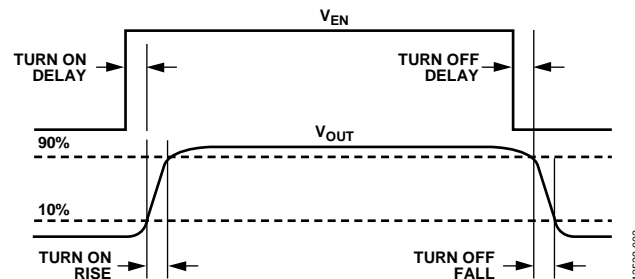

Figure 2. Timing Diagram

## ABSOLUTE MAXIMUM RATINGS

Table 2.

Parameter	Rating
VIN to GND	−0.3 V to +16.5 V
VOU to GND	−0.3 V to VIN
EN to GND	−0.3 V to +16.5 V
Continuous Drain Current	
T <sub>J</sub> = 70°C	±3 A
T <sub>J</sub> = 105°C	±1.6 A
Continuous Diode Current	−50 mA
Storage Temperature Range	−65°C to +150°C
Operating Junction Temperature Range	−40°C to +105°C
Soldering Conditions	JEDEC J-STD-020

Stresses at or above those listed under Absolute Maximum Ratings may cause permanent damage to the product. This is a stress rating only; functional operation of the product at these or any other conditions above those indicated in the operational section of this specification is not implied. Operation beyond the maximum operating conditions for extended periods may affect product reliability.

## THERMAL RESISTANCE

$\theta_{JA}$  is specified for the worst case conditions, that is, a device soldered in a circuit board for surface-mount packages.

Table 3 Thermal Resistance

Package Type	$\theta_{JA}$	$\Psi_{JB}$	Unit
6-Ball, 0.5 mm Pitch WLCSP	260	58	°C/W

## ESD CAUTION



**ESD (electrostatic discharge) sensitive device.** Charged devices and circuit boards can discharge without detection. Although this product features patented or proprietary protection circuitry, damage may occur on devices subjected to high energy ESD. Therefore, proper ESD precautions should be taken to avoid performance degradation or loss of functionality.

## PIN CONFIGURATION AND FUNCTION DESCRIPTIONS

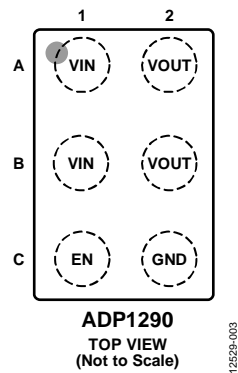

Figure 3. Pin Configuration

Table 4. Pin Function Descriptions

Pin No.	Mnemonic	Description
A1, B1	VIN	Input Voltage.
A2, B2	VOUT	Output Voltage.
C1	EN	Enable Input. Drive the EN pin high to turn on the switch. Drive the EN pin low to turn off the switch.
C2	GND	Ground.

# TYPICAL PERFORMANCE CHARACTERISTICS

$V_{IN} = 6.5\text{ V}$ ,  $V_{EN} = V_{IN}$ ,  $C_{IN} = C_{OUT} = 0\ \mu\text{F}$ ,  $T_A = 25^\circ\text{C}$ , unless otherwise noted.

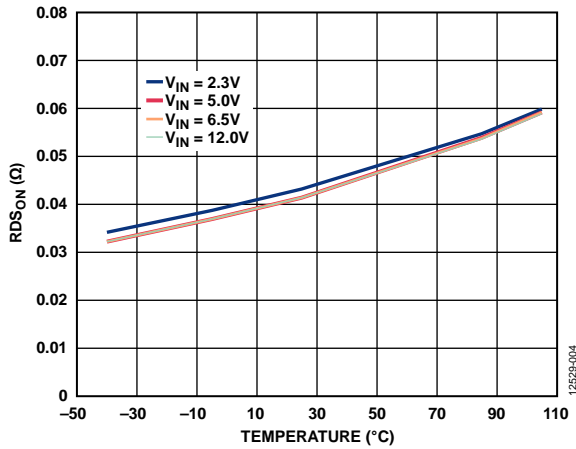

Figure 4.  $R_{DS(on)}$  vs. Temperature, 50 mA, Different Input Voltages ( $V_{IN}$ )

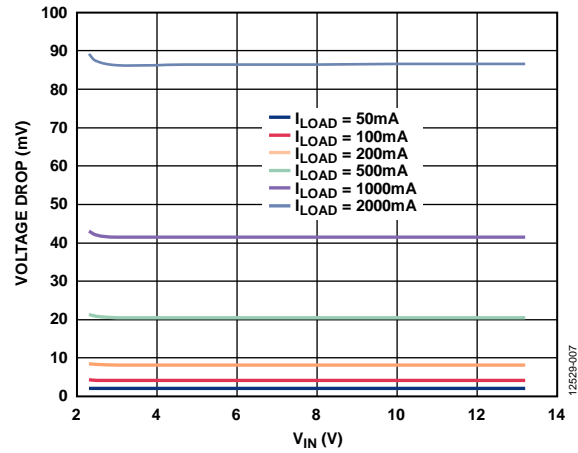

Figure 7. Voltage Drop vs. Input Voltage ( $V_{IN}$ ), Different Load Currents ( $I_{LOAD}$ )

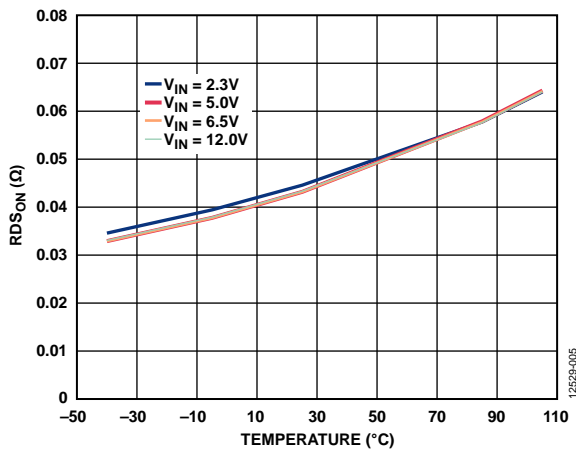

Figure 5.  $R_{DS(on)}$  vs. Temperature, 2 A, Different Input Voltages ( $V_{IN}$ )

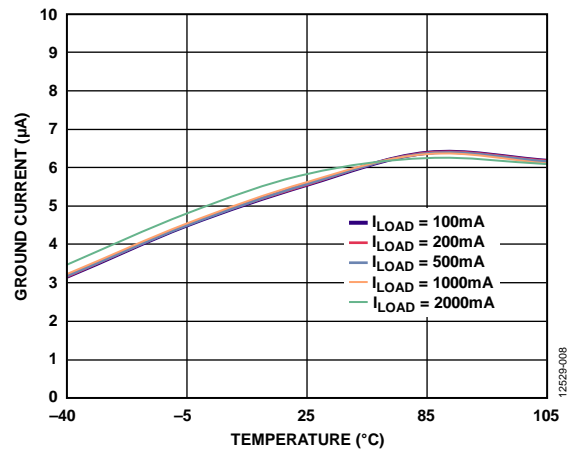

Figure 8. Ground Current vs. Temperature, Different Load Currents,  $V_{IN} = 2.3\text{ V}$

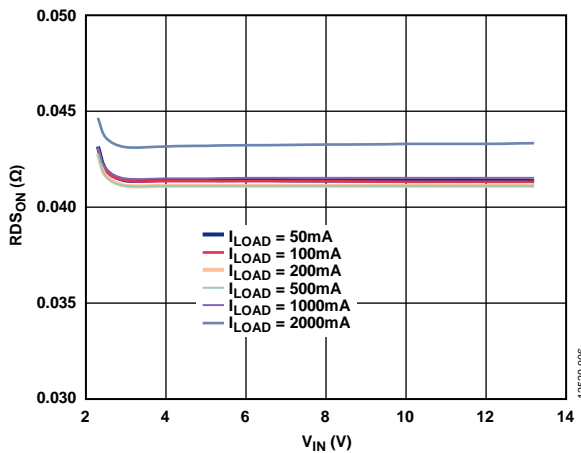

Figure 6.  $R_{DS(on)}$  vs. Input Voltage ( $V_{IN}$ ), Different Load Currents ( $I_{LOAD}$ )

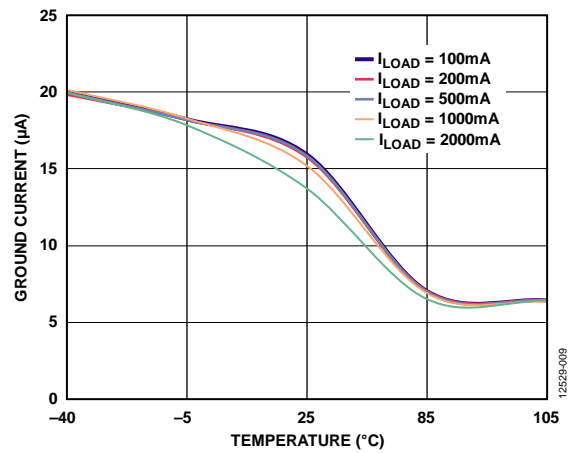

Figure 9. Ground Current vs. Temperature, Different Load Currents,  $V_{IN} = 6.5\text{ V}$

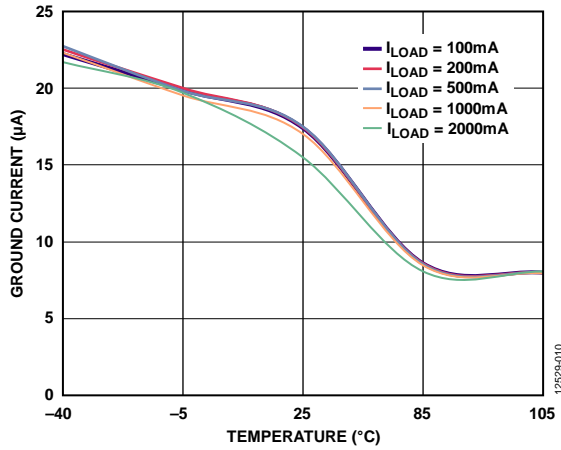

Figure 10. Ground Current vs. Temperature, Different Load Currents,  $V_{IN} = 13.2\text{ V}$

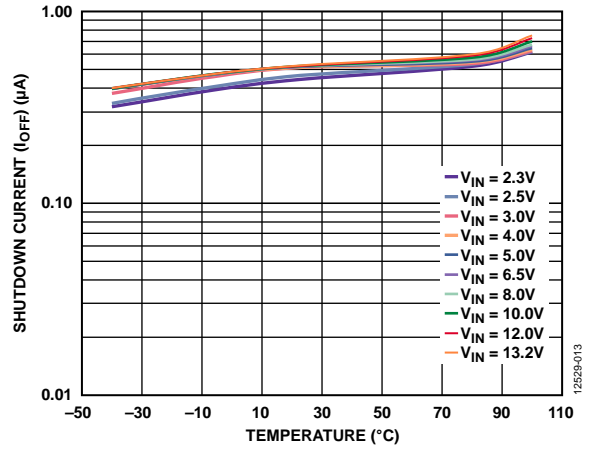

Figure 13. Ground Shutdown Current vs. Temperature,  $V_{OUT} = 0\text{ V}$ , Different Input Voltages ( $V_{IN}$ )

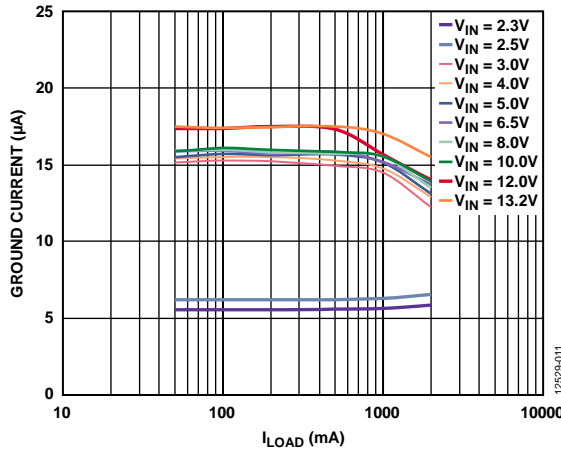

Figure 11. Ground Current vs. Load Current ( $I_{LOAD}$ ), Different Input Voltages ( $V_{IN}$ )

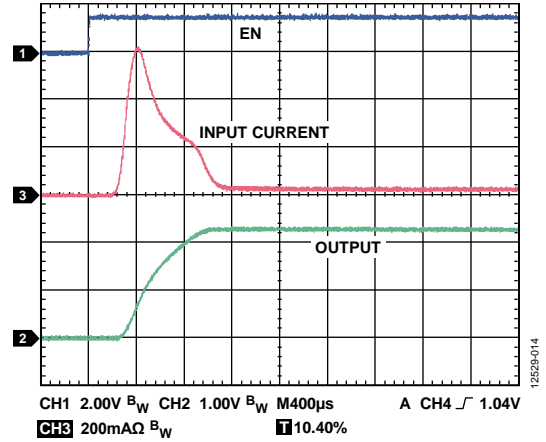

Figure 14. Typical Turn On Time and Inrush Current,  $V_{IN} = 2.3\text{ V}$ ,  $C_{OUT} = 100\text{ }\mu\text{F}$ ,  $R_{LOAD} = 100\text{ }\Omega$

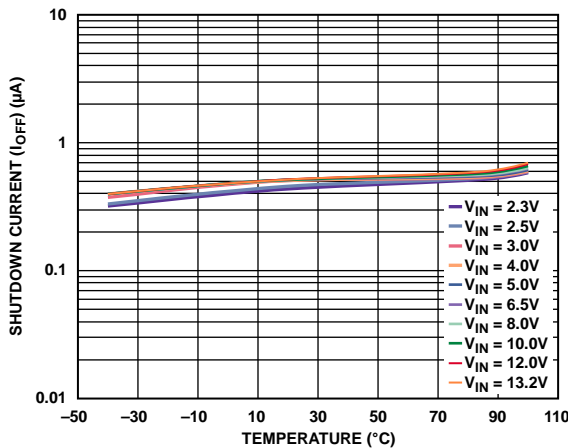

Figure 12. Ground Shutdown Current vs. Temperature, Output Open, Different Input Voltages ( $V_{IN}$ )

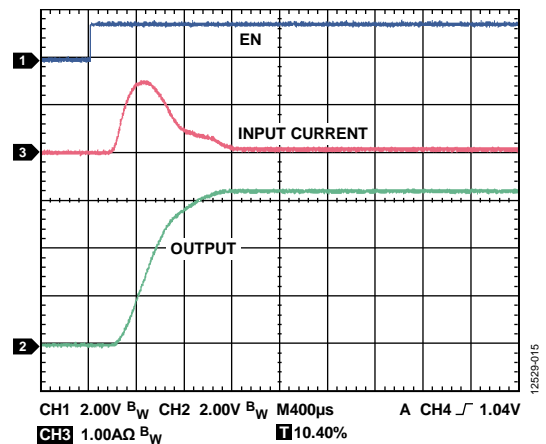

Figure 15. Typical Turn On Time and Inrush Current,  $V_{IN} = 6.5\text{ V}$ ,  $C_{OUT} = 100\text{ }\mu\text{F}$ ,  $R_{LOAD} = 100\text{ }\Omega$



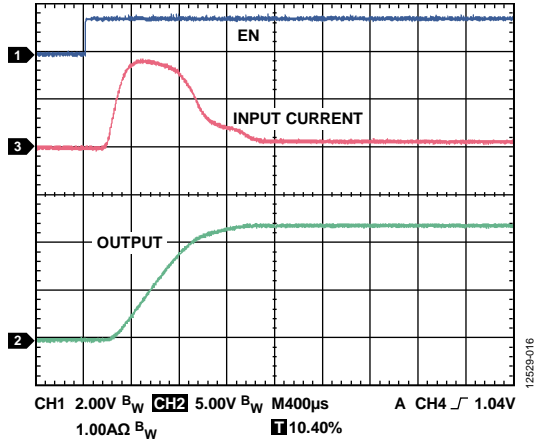

Figure 16. Typical Turn On Time and Inrush Current,  $V_{IN} = 13.2\text{ V}$ ,  $C_{OUT} = 100\ \mu\text{F}$ ,  $R_{LOAD} = 100\ \Omega$

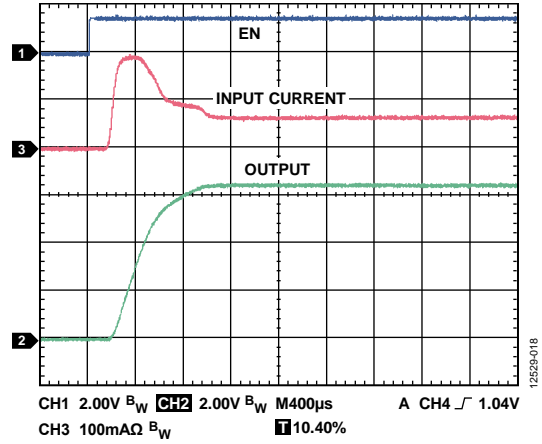

Figure 18. Typical Turn On Time and Inrush Current,  $V_{IN} = 6.5\text{ V}$ ,  $C_{OUT} = 10\ \mu\text{F}$ ,  $R_{LOAD} = 100\ \Omega$

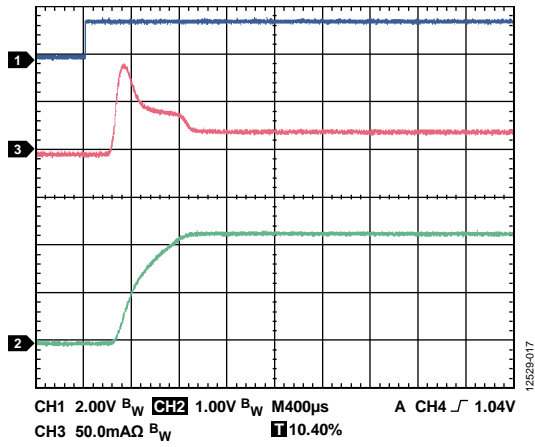

Figure 17. Typical Turn On Time and Inrush Current,  $V_{IN} = 2.3\text{ V}$ ,  $C_{OUT} = 10\ \mu\text{F}$ ,  $R_{LOAD} = 100\ \Omega$

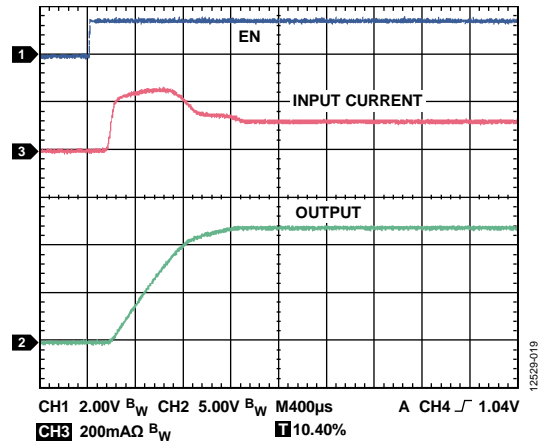

Figure 19. Typical Turn On Time and Inrush Current,  $V_{IN} = 13.2\text{ V}$ ,  $C_{OUT} = 10\ \mu\text{F}$ ,  $R_{LOAD} = 100\ \Omega$

## THEORY OF OPERATION

The **ADP1290** is a high-side NMOS load switch, controlled by an internal charge pump. The **ADP1290** is designed to operate with power supply voltages between 2.3 V and 13.2 V.

An internal charge pump biases the NMOS switch to achieve a relatively constant, ultralow on resistance of 40 m $\Omega$  across the entire input voltage range. The use of the internal charge pump also allows controlled turn on times. Turning the NMOS switch on and off is controlled by the enable input, EN, which is capable of interfacing directly with 1.2 V logic signals.

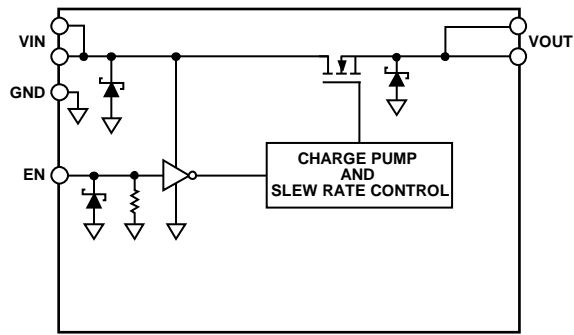

Figure 20. Functional Block Diagram

12529-020

The **ADP1290** is capable of 2 A of continuous current as long as  $T_J$  is less than 85°C. Between 85°C and 105°C, the rated current decreases linearly to 1.6 A.

ESD protection structures are shown in the block diagram as Zener diodes.

The **ADP1290** is a low quiescent current device with a weak 15 nA pull-down current sink on its enable pin (EN).

The **ADP1290** is available in a space-saving 1.0 mm  $\times$  1.5 mm, 0.5 mm pitch, 6-ball WLCSP.

## APPLICATIONS INFORMATION

### CAPACITOR SELECTION

#### Output Capacitor

The ADP1290 is designed for operation with small, space-saving ceramic capacitors but functions with most commonly used capacitors when the effective series resistance (ESR) value is carefully considered. The ESR of the output capacitor affects the response to load transients. A typical 1  $\mu\text{F}$  capacitor with an ESR of 0.1  $\Omega$  or less is recommended for good transient response. Using a larger value of output capacitance improves the transient response to large changes in load current.

#### Input Bypass Capacitor

Connecting at least 1  $\mu\text{F}$  of capacitance from  $V_{\text{IN}}$  to GND reduces the circuit sensitivity to the PCB layout, especially when high source impedance or long input traces are encountered. When an output capacitance of greater than 1  $\mu\text{F}$  is required, increase the input capacitor to match it.

### GROUND CURRENT

The major source for ground current in the ADP1290 is the internal charge pump for the FET drive circuitry. Figure 21 shows the typical ground current when  $V_{\text{EN}} = V_{\text{IN}}$  and varies from 2.3 V to 13.2 V.

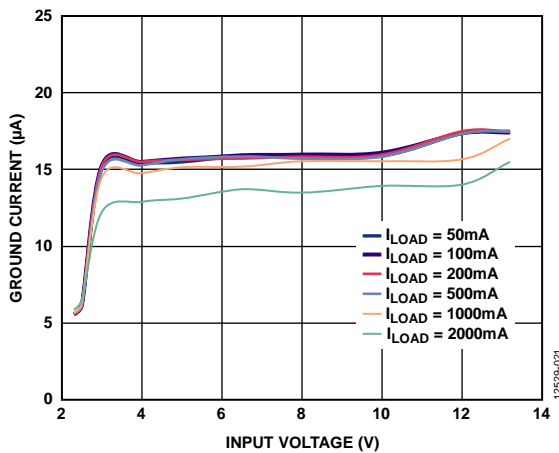

Figure 21. Ground Current vs. Input Voltage ( $V_{\text{IN}}$ ), Different Load Currents ( $I_{\text{LOAD}}$ )

### ENABLE FEATURE

The ADP1290 uses the EN pin to enable and disable the  $V_{\text{OUT}}$  pin under normal operating conditions. As shown in Figure 22, when a rising voltage ( $V_{\text{EN}}$ ) on the EN pin crosses the active threshold, the  $V_{\text{OUT}}$  pin turns on. When a falling voltage ( $V_{\text{EN}}$ ) on the EN pin crosses the inactive threshold, the  $V_{\text{OUT}}$  pin turns off.

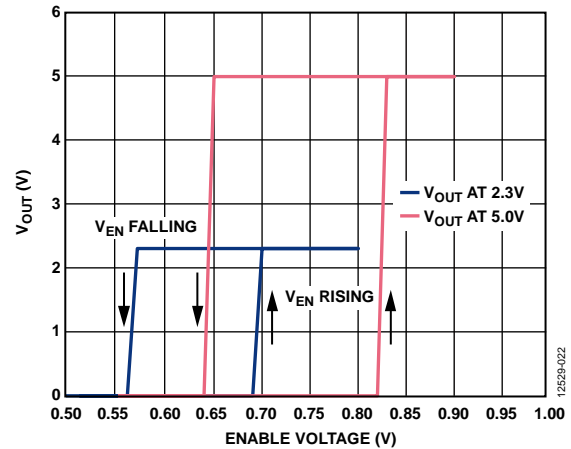

Figure 22. Typical EN Operation

As shown in Figure 22, the EN pin has hysteresis built into it. The hysteresis prevents on/off oscillations that can occur due to noise on the EN pin as it passes through the threshold points.

The EN pin rising and falling thresholds derive from the  $V_{\text{IN}}$  voltage; therefore, these thresholds vary with the changing input voltage. Figure 23 shows the typical EN rising and falling thresholds when the input voltage varies from 2.3 V to 13.2 V.

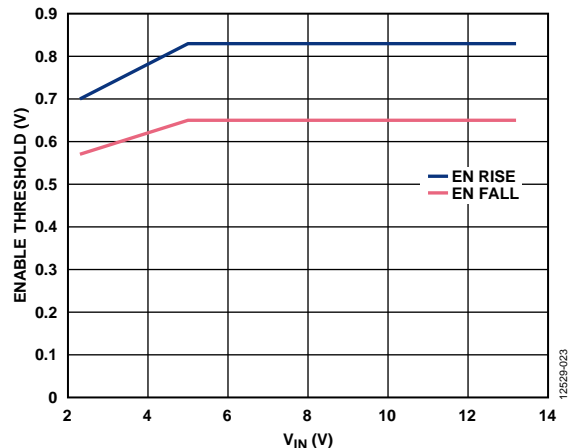

Figure 23. Typical EN Thresholds (Rising and Falling) vs. Input Voltage ( $V_{\text{IN}}$ )

**TIMING**

Turn on delay is defined as the interval between the time that  $V_{EN}$  exceeds the rising threshold voltage and when  $V_{OUT}$  rises to ~10% of its final value. The ADP1290 includes circuitry that has a typical 250  $\mu$ s turn on delay and a controlled rise time to limit the  $V_{IN}$  inrush current. As shown in Figure 24 and Figure 25, the turn on delay is nearly independent of the input voltage.

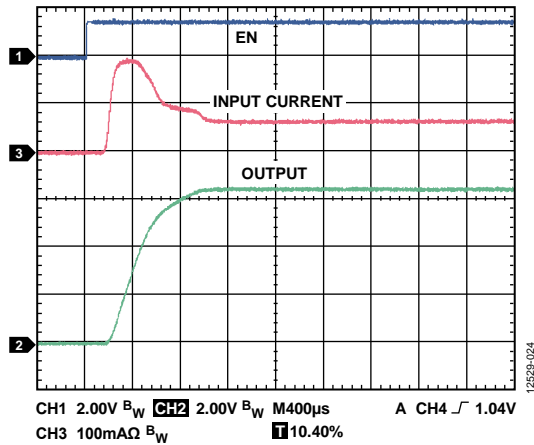

Figure 24. Typical Turn On Time and Inrush Current,  $V_{IN} = 2.5 V$ ,  $C_{OUT} = 10 \mu F$ ,  $R_{LOAD} = 100 \Omega$

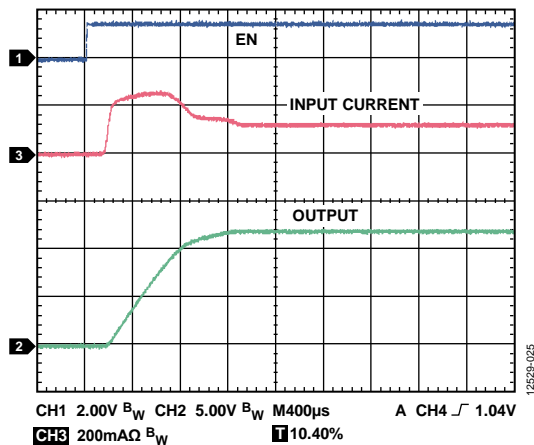

Figure 25. Typical Turn On Time and Inrush Current,  $V_{IN} = 6.5 V$ ,  $C_{OUT} = 10 \mu F$ ,  $R_{LOAD} = 100 \Omega$

The rise time is defined as the time it takes the output voltage to rise from 10% to 90% of  $V_{OUT}$  reaching its final value. The turn on delay is dependent on the rise time of the internal charge pump.

For very large values of output capacitance, the RC time constant (where C is the load capacitance,  $C_{LOAD}$ , and R is the  $R_{DS(ON)} || R_{LOAD}$ ) can become a factor in the rise time of the output voltage. Because  $R_{DS(ON)}$  is much smaller than  $R_{LOAD}$ , an adequate approximation for RC is  $R_{DS(ON)} \times C_{LOAD}$ . An input or load capacitor is not required for the ADP1290; however, capacitors can suppress noise on the board.

The turn off time is defined as the time it takes for the output voltage to fall from 90% to 10% of  $V_{OUT}$  reaching its final value. The turn off time is also dependent on the RC time constant of the output capacitance ( $C_{LOAD}$ ) and load resistance ( $R_{LOAD}$ ).

Figure 26 and Figure 27 show the typical turn off times with  $V_{IN} = 6.5 V$ ,  $C_{OUT} = 10 \mu F$  and  $100 \mu F$ , and  $R_{LOAD} = 100 \Omega$ .

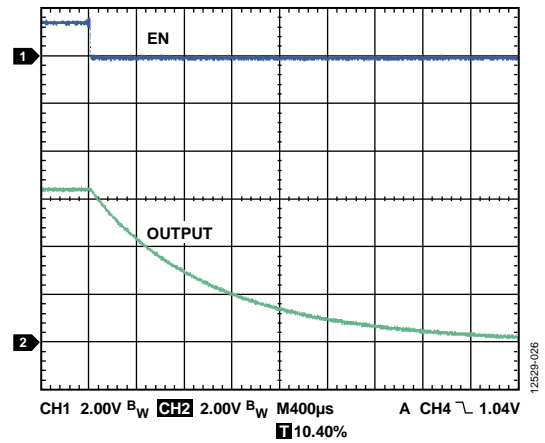

Figure 26. Typical Turn Off Time,  $C_{OUT} = 10 \mu F$ ,  $R_{LOAD} = 100 \Omega$

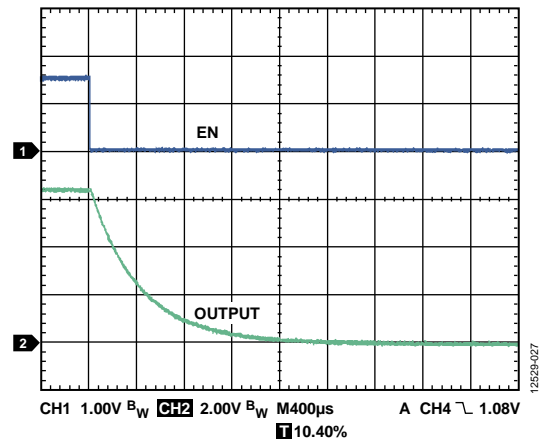

Figure 27. Typical Turn Off Time,  $C_{OUT} = 100 \mu F$ ,  $R_{LOAD} = 100 \Omega$

**CURRENT AND THERMAL OVERLOAD PRECAUTIONS**

The ADP1290 is not protected against damage due to excessive power dissipation and does not have thermal overload protection circuits. To prevent permanent damage, never allow current through the ADP1290 to exceed its rated value for more than a few milliseconds. Permanent damage can also occur if the output is shorted to ground

**THERMAL CONSIDERATIONS**

To guarantee reliable operation, the junction temperature of the ADP1290 must not exceed 105°C. To ensure that the junction temperature stays below this maximum value, the user must be aware of the parameters that contribute to junction temperature changes. These parameters include ambient temperature, power dissipation in the power device, and thermal resistances between the junction and ambient air ( $\theta_{JA}$ ). The  $\theta_{JA}$  number is dependent on the package assembly and the amount of copper used to solder the package pins to the PCB.

OUTLINE DIMENSIONS

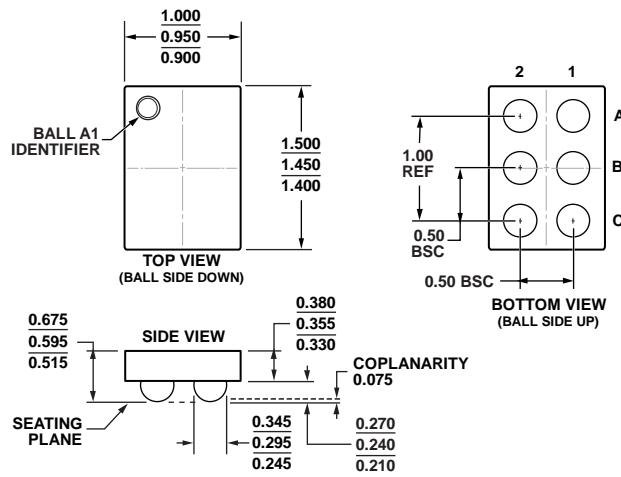

11-08-2012-B

Figure 28. 6-Ball Wafer Level Chip Scale Package [WLCSP] (CB-6-2)  
Dimensions shown in millimeters

ORDERING GUIDE

Model <sup>1</sup>	Temperature Range	Package Description	Package Option	Branding
ADP1290ACBZ-R7	-40°C to +105°C	6-Ball Wafer Level Chip Scale Package [WLCSP]	CB-6-2	CL
ADP1290CB-EVALZ		Evaluation Board		

<sup>1</sup> Z = RoHS Compliant Part.