



Is Now Part of



ON Semiconductor®

To learn more about ON Semiconductor, please visit our website at
www.onsemi.com

ON Semiconductor and the ON Semiconductor logo are trademarks of Semiconductor Components Industries, LLC dba ON Semiconductor or its subsidiaries in the United States and/or other countries. ON Semiconductor owns the rights to a number of patents, trademarks, copyrights, trade secrets, and other intellectual property. A listing of ON Semiconductor's product/patent coverage may be accessed at www.onsemi.com/site/pdf/Patent-Marking.pdf. ON Semiconductor reserves the right to make changes without further notice to any products herein. ON Semiconductor makes no warranty, representation or guarantee regarding the suitability of its products for any particular purpose, nor does ON Semiconductor assume any liability arising out of the application or use of any product or circuit, and specifically disclaims any and all liability, including without limitation special, consequential or incidental damages. Buyer is responsible for its products and applications using ON Semiconductor products, including compliance with all laws, regulations and safety requirements or standards, regardless of any support or applications information provided by ON Semiconductor. "Typical" parameters which may be provided in ON Semiconductor data sheets and/or specifications can and do vary in different applications and actual performance may vary over time. All operating parameters, including "Typicals" must be validated for each customer application by customer's technical experts. ON Semiconductor does not convey any license under its patent rights nor the rights of others. ON Semiconductor products are not designed, intended, or authorized for use as a critical component in life support systems or any FDA Class 3 medical devices or medical devices with a same or similar classification in a foreign jurisdiction or any devices intended for implantation in the human body. Should Buyer purchase or use ON Semiconductor products for any such unintended or unauthorized application, Buyer shall indemnify and hold ON Semiconductor and its officers, employees, subsidiaries, affiliates, and distributors harmless against all claims, costs, damages, and expenses, and reasonable attorney fees arising out of, directly or indirectly, any claim of personal injury or death associated with such unintended or unauthorized use, even if such claim alleges that ON Semiconductor was negligent regarding the design or manufacture of the part. ON Semiconductor is an Equal Opportunity/Affirmative Action Employer. This literature is subject to all applicable copyright laws and is not for resale in any manner.



RHRP3060

30 A, 600 V Hyperfast Diodes

Features

- Hyperfast Recovery $t_{rr} = 45 \text{ ns}$ (@ $I_F = 30 \text{ A}$)
- Max Forward Voltage, $V_F = 2.1 \text{ V}$ (@ $T_C = 25^\circ\text{C}$)
- 600 V Reverse Voltage and High Reliability
- Avalanche Energy Rated
- RoHS Compliant

Description

The RHRP3060 is a hyperfast diode with soft recovery characteristics. It has the half recovery time of ultrafast diodes and is silicon nitride passivated ionimplanted epitaxial planar construction. These devices are intended to be used as freewheeling clamping diodes and diodes in a variety of switching power supplies and other power switching applications. Their low stored charge and hyperfast soft recovery minimize ringing and electrical noise in many power switching circuits reducing power loss in the switching transistors.

Applications

- Switching Power Supplies
- Power Switching Circuits
- General Purpose

Ordering Informations

Part Number	Package	Brand
RHRP3060	TO-220AC-2L	RHRP3060

Pin Assignments

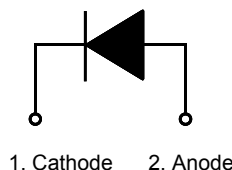
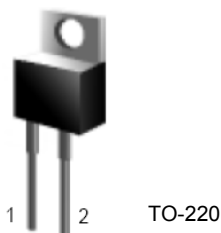

Absolute Maximum Ratings

Symbol	Parameter	RHRP3060	Unit
V_{RRM}	Peak Repetitive Reverse Voltage	600	V
V_{RWM}	Working Peak Reverse Voltage	600	V
V_R	DC Blocking Voltage	600	V
$I_{F(AV)}$	Average Rectified Forward Current ($T_C = 120^\circ\text{C}$)	30	A
I_{FRM}	Repetitive Peak Surge Current (Square Wave, 20KHz)	70	A
I_{FSM}	Nonrepetitive Peak Surge Current (Halfwave, 1 Phase, 60Hz)	325	A
P_D	Maximum Power Dissipation	125	W
E_{AVL}	Avalanche Energy (See Figures 10 and 11)	20	mJ
T_J, T_{STG}	Operating and Storage Temperature	-65 to 175	$^\circ\text{C}$

Electrical Characteristics T_C = 25°C unless otherwise noted

Symbol	Test Conditions	RHRP3060			Unit
		Min.	Typ.	Max.	
V _F	I _F = 30 A	-	-	2.1	V
	I _F = 30 A, T _C = 150°C	-	-	1.7	V
I _R	V _R = 400 V	-	-	-	μA
	V _R = 600 V	-	-	250	μA
	V _R = 400 V, T _C = 150°C	-	-	-	mA
	V _R = 600 V, T _C = 150°C	-	-	1.0	mA
t _{rr}	I _F = 1 A, dI _F /dt = 200 A/μs	-	-	40	ns
	I _F = 30 A, dI _F /dt = 200 A/μs	-	-	45	ns
t _a	I _F = 30 A, dI _F /dt = 200 A/μs	-	22	-	ns
t _b	I _F = 30 A, dI _F /dt = 200 A/μs	-	18	-	ns
Q _{RR}	I _F = 30 A, dI _F /dt = 200 A/μs	-	100	-	nC
C _J	V _R = 600 V, I _F = 0 A	-	85	-	pF
R _{θJC}		-	-	1.2	°C/W

DEFINITIONS

V_F = Instantaneous forward voltage (pw = 300μs, D = 2%)

I_R = Instantaneous reverse current.

t_{rr} = Reverse recovery time (See Figure 9), summation of t_a + t_b.

t_a = Time to reach peak reverse current (See Figure 9).

t_b = Time from peak I_{RM} to projected zero crossing of I_{RM} based on a straight line from peak I_{RM} through 25% of I_{RM} (See Figure 9).

Q_{RR} = Reverse recovery charge.

C_J = Junction Capacitance.

R_{θJC} = Thermal resistance junction to case.

pw = pulse width.

D = Duty cycle.

Typical Performance Characteristics

Figure 1. Forward Current vs Forward Voltage

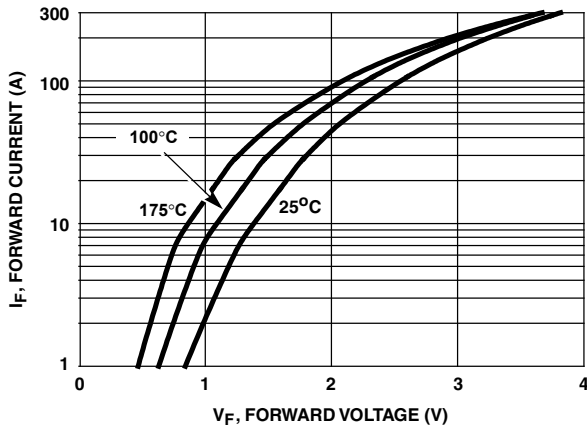

Figure 2. Reverse Current vs Reverse Voltage

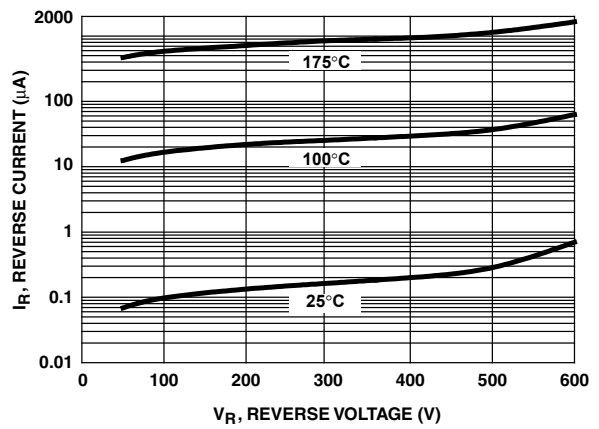

Figure 3. t_{rr} , t_a and t_b Curves vs Forward Current

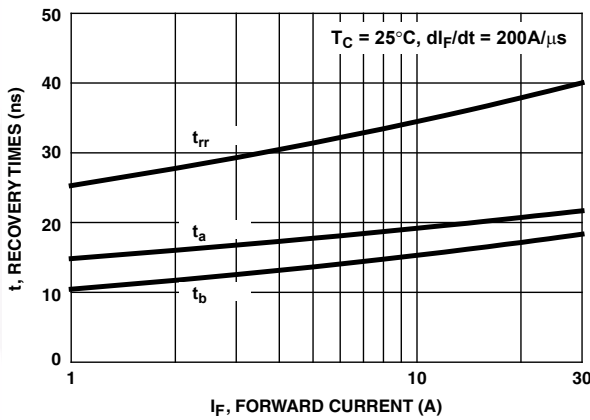

Figure 4. t_{rr} , t_a and t_b Curves vs Forward Current

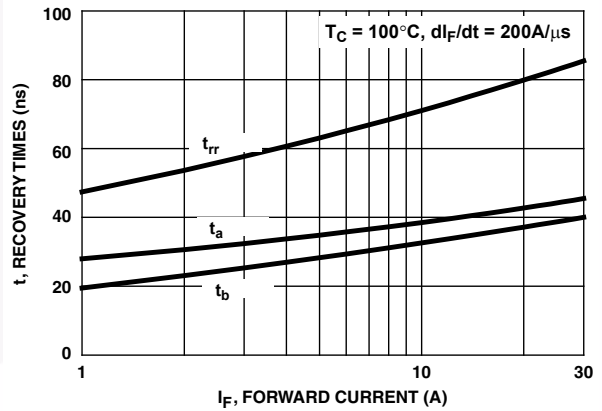

Figure 5. t_{rr} , t_a and t_b Curves vs Forward Current

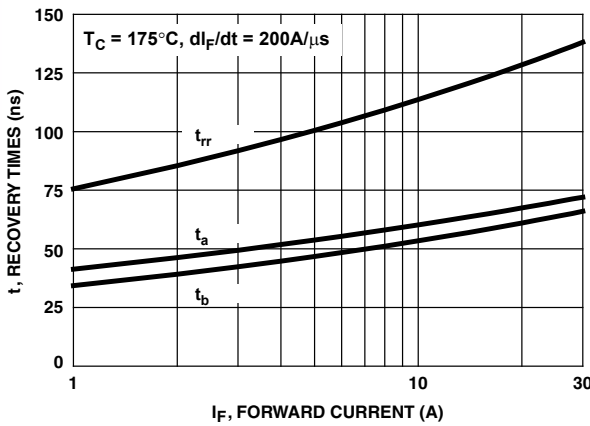
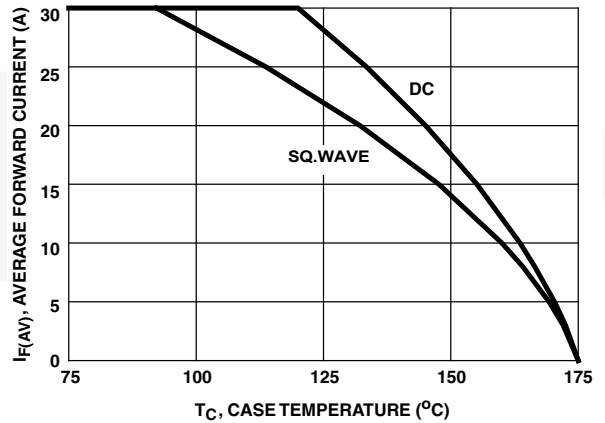
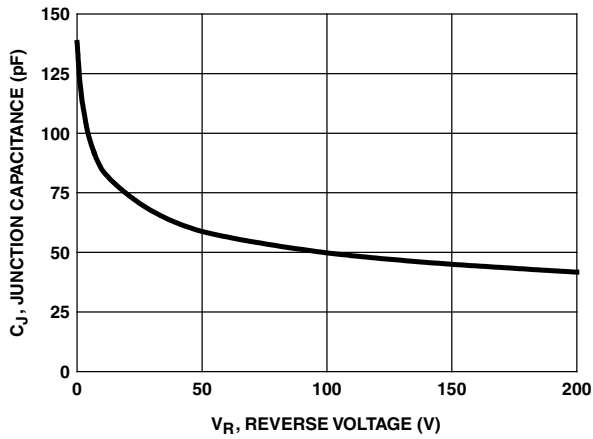

Figure 6. Current Derating Curve



Typical Performance Characteristics (Continued)

Figure 7. Junction Capacitance vs Reverse Voltage



Test Circuit and Waveforms

Figure 8. t_{rr} Test Circuit

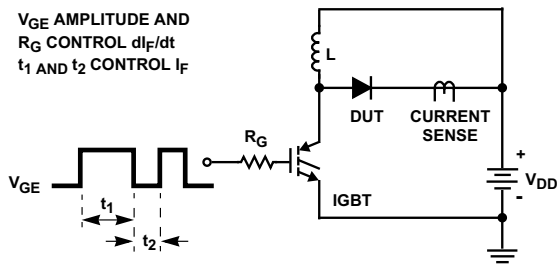

Figure 9. t_{rr} Waveforms and Definitions

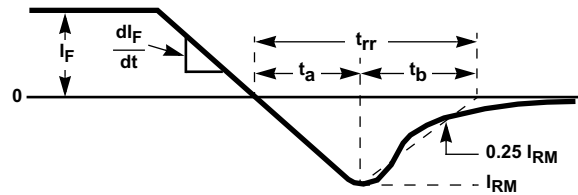

Figure 10. Avalanche Energy Test Circuit

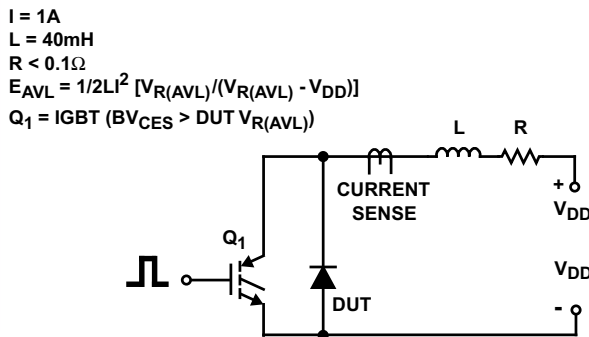
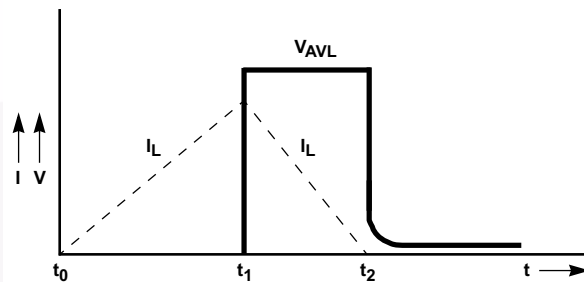

Figure 11. Avalanche Current and Voltage Waveforms





NOTES:

- A. PACKAGE REFERENCE: JEDEC TO220,ISSUE K, VARIATION AC,DATED APRIL 2002.
- B. ALL DIMENSIONS ARE IN MILLIMETERS.
- C. DIMENSION AND TOLERANCE AS PER ASME Y14.5-2009.
- D. DIMENSIONS ARE EXCLUSIVE OF BURRS, MOLD FLASH AND TIE BAR PROTRUSIONS.
- E. DRAWING FILE NAME: TO220A02REV5

ON Semiconductor and  are trademarks of Semiconductor Components Industries, LLC dba ON Semiconductor or its subsidiaries in the United States and/or other countries. ON Semiconductor owns the rights to a number of patents, trademarks, copyrights, trade secrets, and other intellectual property. A listing of ON Semiconductor's product/patent coverage may be accessed at www.onsemi.com/site/pdf/Patent-Marking.pdf. ON Semiconductor reserves the right to make changes without further notice to any products herein. ON Semiconductor makes no warranty, representation or guarantee regarding the suitability of its products for any particular purpose, nor does ON Semiconductor assume any liability arising out of the application or use of any product or circuit, and specifically disclaims any and all liability, including without limitation special, consequential or incidental damages. Buyer is responsible for its products and applications using ON Semiconductor products, including compliance with all laws, regulations and safety requirements or standards, regardless of any support or applications information provided by ON Semiconductor. "Typical" parameters which may be provided in ON Semiconductor data sheets and/or specifications can and do vary in different applications and actual performance may vary over time. All operating parameters, including "Typicals" must be validated for each customer application by customer's technical experts. ON Semiconductor does not convey any license under its patent rights nor the rights of others. ON Semiconductor products are not designed, intended, or authorized for use as a critical component in life support systems or any FDA Class 3 medical devices or medical devices with a same or similar classification in a foreign jurisdiction or any devices intended for implantation in the human body. Should Buyer purchase or use ON Semiconductor products for any such unintended or unauthorized application, Buyer shall indemnify and hold ON Semiconductor and its officers, employees, subsidiaries, affiliates, and distributors harmless against all claims, costs, damages, and expenses, and reasonable attorney fees arising out of, directly or indirectly, any claim of personal injury or death associated with such unintended or unauthorized use, even if such claim alleges that ON Semiconductor was negligent regarding the design or manufacture of the part. ON Semiconductor is an Equal Opportunity/Affirmative Action Employer. This literature is subject to all applicable copyright laws and is not for resale in any manner.

PUBLICATION ORDERING INFORMATION

LITERATURE FULFILLMENT:

Literature Distribution Center for ON Semiconductor
19521 E. 32nd Pkwy, Aurora, Colorado 80011 USA
Phone: 303-675-2175 or 800-344-3860 Toll Free USA/Canada
Fax: 303-675-2176 or 800-344-3867 Toll Free USA/Canada
Email: orderlit@onsemi.com

N. American Technical Support: 800-282-9855 Toll Free
USA/Canada
Europe, Middle East and Africa Technical Support:
Phone: 421 33 790 2910
Japan Customer Focus Center
Phone: 81-3-5817-1050

ON Semiconductor Website: www.onsemi.com
Order Literature: <http://www.onsemi.com/orderlit>
For additional information, please contact your local
Sales Representative