

FEATURES

Single 1.8 V supply operation
SNR: 49.3 dBFS at 200 MHz input at 500 MSPS
SFDR: 65 dBc at 200 MHz input at 500 MSPS
Low power: 315 mW at 500 MSPS
On-chip interleaved clocking
On-chip reference and track-and-hold
1.2 V p-p analog input range for each channel
Differential input with 500 MHz bandwidth
LVDS-compliant digital output
On-chip voltage reference and sample-and-hold circuit
DNL: ± 0.2 LSB
Serial port control options
 Interleaved clock timing adjustment
 Offset binary, Gray code, or twos complement data format
 Optional clock duty cycle stabilizer
 Built-in selectable digital test pattern generation
Pin-programmable power-down function
Available in 48-lead LFCSP

APPLICATIONS

Battery-powered instruments
Handheld scope meters
Low cost digital oscilloscopes
OTS: video over fiber

GENERAL DESCRIPTION

The **AD9286** is an 8-bit, monolithic sampling, analog-to-digital converter (ADC) that supports interleaved operation and is optimized for low cost, low power, and ease of use. Each ADC operates at up to a 250 MSPS conversion rate with outstanding dynamic performance.

The **AD9286** takes a single sample clock and, with an on-chip clock divider, time interleaves the two ADC cores (each running at one-half the clock frequency) to achieve the rated 500 MSPS. By using the SPI, the user can accurately adjust the timing of the sampling edge per ADC to minimize the image spur energy.

The ADC requires a single 1.8 V supply and an encode clock for full performance operation. No external reference components are required for many applications. The digital outputs are LVDS compatible.

The **AD9286** is available in a Pb-free, 48-lead LFCSP that is specified over the industrial temperature range of -40°C to $+85^{\circ}\text{C}$.

PRODUCT HIGHLIGHTS

1. Integrated 8-Bit, 500 MSPS ADC.
2. Single 1.8 V Supply Operation with LVDS Outputs.
3. Power-Down Option Controlled via a Pin-Programmable Setting.

FUNCTIONAL BLOCK DIAGRAM

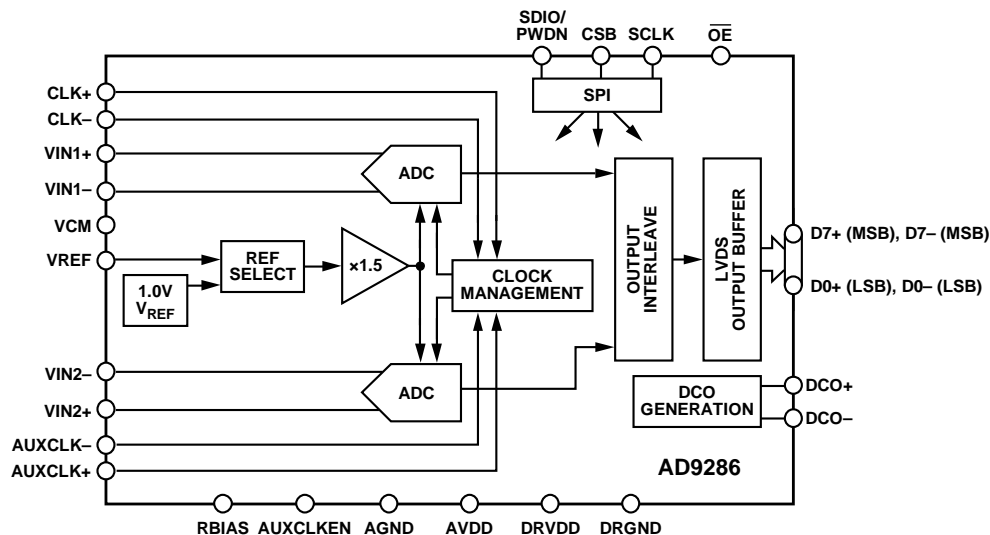

Figure 1.

Rev. C

[Document Feedback](#)

Information furnished by Analog Devices is believed to be accurate and reliable. However, no responsibility is assumed by Analog Devices for its use, nor for any infringements of patents or other rights of third parties that may result from its use. Specifications subject to change without notice. No license is granted by implication or otherwise under any patent or patent rights of Analog Devices. Trademarks and registered trademarks are the property of their respective owners.

One Technology Way, P.O. Box 9106, Norwood, MA 02062-9106, U.S.A.
 Tel: 781.329.4700 ©2011–2015 Analog Devices, Inc. All rights reserved.
[Technical Support](#) www.analog.com

AD9286* Product Page Quick Links

Last Content Update: 11/01/2016

[Comparable Parts](#)

View a parametric search of comparable parts

[Evaluation Kits](#)

- AD9286 Evaluation Board

[Documentation](#)

Application Notes

- AN-1142: Techniques for High Speed ADC PCB Layout
- AN-282: Fundamentals of Sampled Data Systems
- AN-345: Grounding for Low-and-High-Frequency Circuits
- AN-501: Aperture Uncertainty and ADC System Performance
- AN-586: LVDS Outputs for High Speed A/D Converters
- AN-715: A First Approach to IBIS Models: What They Are and How They Are Generated
- AN-737: How ADIsimADC Models an ADC
- AN-742: Frequency Domain Response of Switched-Capacitor ADCs
- AN-756: Sampled Systems and the Effects of Clock Phase Noise and Jitter
- AN-827: A Resonant Approach to Interfacing Amplifiers to Switched-Capacitor ADCs
- AN-835: Understanding High Speed ADC Testing and Evaluation
- AN-851: A WiMax Double Downconversion IF Sampling Receiver Design
- AN-877: Interfacing to High Speed ADCs via SPI
- AN-878: High Speed ADC SPI Control Software
- AN-905: Visual Analog Converter Evaluation Tool Version 1.0 User Manual
- AN-935: Designing an ADC Transformer-Coupled Front End

Data Sheet

- AD9286: 8-Bit, 500 MSPS, 1.8 V Analog-to-Digital Converter (ADC) Data Sheet

User Guides

- UG-191: Evaluating the AD9286 Analog-to-Digital Converter

[Tools and Simulations](#)

- Visual Analog

[Reference Materials](#)

Technical Articles

- MS-2210: Designing Power Supplies for High Speed ADC

[Design Resources](#)

- ad9286 Material Declaration
- PCN-PDN Information
- Quality And Reliability
- Symbols and Footprints

[Discussions](#)

View all ad9286 EngineerZone Discussions

[Sample and Buy](#)

Visit the product page to see pricing options

[Technical Support](#)

Submit a technical question or find your regional support number

* This page was dynamically generated by Analog Devices, Inc. and inserted into this data sheet. Note: Dynamic changes to the content on this page does not constitute a change to the revision number of the product data sheet. This content may be frequently modified.

TABLE OF CONTENTS

Features	1	Voltage Reference	15
Applications	1	RBIAS	15
General Description	1	Clock Input Considerations	16
Product Highlights	1	Digital Outputs	18
Functional Block Diagram	1	Built-In Self-Test (BIST) and Output Test	19
Revision History	2	Built-In Self-Test (BIST)	19
Specifications	3	Output Test Modes	19
DC Specifications	3	Serial Port Interface (SPI)	20
AC Specifications	4	Configuration Using the SPI	20
Digital Specifications	5	Hardware Interface	21
Switching Specifications	6	Configuration Without the SPI	21
SPI Timing Specifications	6	SPI Accessible Features	21
Absolute Maximum Ratings	9	Memory Map	22
Thermal Resistance	9	Reading the Memory Map Register Table	22
ESD Caution	9	Memory Map Register Table	23
Pin Configuration and Function Descriptions	10	Memory Map Register Descriptions	25
Typical Performance Characteristics	12	Applications Information	26
Equivalent Circuits	14	Design Guidelines	26
Theory of Operation	15	Outline Dimensions	27
ADC Architecture	15	Ordering Guide	27
Analog Input Considerations	15		

REVISION HISTORY

1/15—Rev. B to Rev. C

Changes to Table 13	24
---------------------------	----

6/13—Rev. A to Rev. B

Changes to Clock Input Parameters, Table 4	6
Changes to Clocking Modes Section	16
Changes to Table 9	17
Changes to Register 0x09, Table 13	23

3/11—Rev. 0 to Rev. A

Changes to General Description, ADC Conversion Rate	1
---	---

1/11—Revision 0: Initial Version

SPECIFICATIONS

DC SPECIFICATIONS

AVDD = 1.8 V, DRVDD = 1.8 V, 1.0 V internal ADC reference, unless otherwise noted.

Table 1.

Parameter ¹	Temperature	Min	Typ	Max	Unit
RESOLUTION	Full	8			Bits
DC ACCURACY					
Differential Nonlinearity	Full		±0.2	±0.4	LSB
Integral Nonlinearity	Full		±0.1	±0.3	LSB
No Missing Codes	Full		Guaranteed		
Offset Error	Full	0	±0.4	±2.1	% FS
Gain Error	Full	0	±2	±2.8	% FS
MATCHING CHARACTERISTICS					
Offset Error ²	Full	0	±0.4	±2.1	% FS
Gain Error	Full	0	±0.05	±0.2	% FS
TEMPERATURE DRIFT					
Offset Error	Full		±2		ppm/°C
Gain Error	Full		±20		ppm/°C
ANALOG INPUT					
Input Span	Full		1.2		V p-p
Input Common-Mode Voltage	Full		1.4		V
Input Resistance (Differential)	Full		16		kΩ
Input Capacitance (Differential)	Full		250		fF
Full Power Bandwidth	Full		700		MHz
VOLTAGE REFERENCE					
Internal Reference	Full	0.97	1	1.03	V
Input Resistance	Full		3		kΩ
POWER SUPPLIES					
Supply Voltage					
AVDD	Full	1.7	1.8	1.9	V
DRVDD	Full	1.7	1.8	1.9	V
Supply Current					
I _{AVDD}	Full		125	130	mA
I _{DRVDD}	Full		51	54	mA
POWER CONSUMPTION					
Sine Wave Input ³	Full		315	330	mW
Power-Down Power	Full		0.3	1.7	mW

¹ See the [AN-835 Application Note](#), *Understanding High Speed ADC Testing and Evaluation*, for a complete set of definitions and an explanation of how these tests were completed.

² See the Interleave Performance section.

³ Measured with a low frequency, full-scale sine wave, with approximately 5 pF loading on each output bit.

AC SPECIFICATIONS

AVDD = 1.8 V, DRVDD = 1.8 V, 1.0 V internal ADC reference, VIN = -1.0 dBFS differential input, optimum timing value set, unless otherwise noted.

Table 2.

Parameter	Temperature	Min	Typ	Max	Unit
SIGNAL-TO-NOISE RATIO (SNR)					
$f_{IN} = 10.3$ MHz	25°C		49.3		dBFS
$f_{IN} = 70$ MHz	25°C		49.3		dBFS
$f_{IN} = 96.6$ MHz	Full	48.8	49.3		dBFS
$f_{IN} = 220$ MHz	25°C		49.3		dBFS
SIGNAL-TO-NOISE-AND-DISTORTION (SINAD)					
$f_{IN} = 10.3$ MHz	25°C		49.2		dBFS
$f_{IN} = 70$ MHz	25°C		49.2		dBFS
$f_{IN} = 96.6$ MHz	Full	48.7	49.2		dBFS
$f_{IN} = 220$ MHz	25°C		49.2		dBFS
EFFECTIVE NUMBER OF BITS (ENOB)					
$f_{IN} = 10.3$ MHz	25°C		7.9		Bits
$f_{IN} = 70$ MHz	25°C		7.9		Bits
$f_{IN} = 96.6$ MHz	Full	7.8	7.9		Bits
$f_{IN} = 220$ MHz	25°C		7.9		Bits
WORST SECOND OR THIRD HARMONIC					
$f_{IN} = 10.3$ MHz	25°C		-70		dBc
$f_{IN} = 70$ MHz	25°C		-70		dBc
$f_{IN} = 96.6$ MHz	Full		-69	-61	dBc
$f_{IN} = 220$ MHz	25°C		-65		dBc
SPURIOUS-FREE DYNAMIC RANGE (SFDR) ¹					
$f_{IN} = 10.3$ MHz	25°C		70		dBc
$f_{IN} = 70$ MHz	25°C		70		dBc
$f_{IN} = 96.6$ MHz	Full	61	68		dBc
$f_{IN} = 220$ MHz	25°C		65		dBc
WORST OTHER HARMONIC OR SPUR					
$f_{IN} = 10.3$ MHz	25°C		-71		dBc
$f_{IN} = 70$ MHz	25°C		-71		dBc
$f_{IN} = 96.6$ MHz	Full		-71	-64	dBc
$f_{IN} = 220$ MHz	25°C		-67		dBc
CROSSTALK	Full		-80		dBc

¹ Excludes offset and alias spur (see the Interleave Performance section).

DIGITAL SPECIFICATIONS

AVDD = 1.8 V, DRVDD = 1.8 V, 1.0 V internal ADC reference, AIN = 5 MHz, full temperature, unless otherwise noted.

Table 3.

Parameter ¹	Temperature	Min	Typ	Max	Unit
CLOCK INPUTS (CLK+, CLK-, AUXCLK+, AUXCLK-)					
Logic Compliance			LVDS/PECL		
Internal Common-Mode Bias	Full		1.2		V
Differential Input Voltage ²	Full	0.2		6	V p-p
Input Voltage Range	Full	AVDD - 0.3		AVDD + 1.6	V
High Level Input Voltage	Full	1.2		3.6	V
Low Level Input Voltage	Full	0		0.8	V
High Level Input Current	Full	-10		+10	μA
Low Level Input Current	Full	-10		+10	μA
Input Resistance (Differential)	25°C		20		kΩ
Input Capacitance	25°C		4		pF
LOGIC INPUTS					
CSB					
High Level Input Voltage	Full	1.2		DRVDD + 0.3	V
Low Level Input Voltage	Full	0		0.8	V
High Level Input Current	Full	-5	-0.4	+5	μA
Low Level Input Current	Full	-80	-63	-50	μA
Input Resistance	25°C		30		kΩ
Input Capacitance	25°C		2		pF
SCLK, SDIO/PWDN, AUXCLKEN, \overline{OE}					
High Level Input Voltage	Full	1.2		DRVDD + 0.3	V
Low Level Input Voltage	Full	0		0.8	V
High Level Input Current	Full	50	57	70	μA
Low Level Input Current	Full	-5	-0.4	+5	μA
Input Resistance	25°C		30		kΩ
Input Capacitance	25°C		2		pF
DIGITAL OUTPUTS (D7+, D7- to D0+, D0-), LVDS					
DRVDD = 1.8 V					
Differential Output Voltage (V _{OD})	Full	290	345	400	mV
Output Offset Voltage (V _{OS})	Full	1.15	1.25	1.35	V
Output Coding (Default)			Offset binary		

¹ See the [AN-835 Application Note, Understanding High Speed ADC Testing and Evaluation](#), for a complete set of definitions and an explanation of how these tests were completed.

² Specified for LVDS and LVPECL only.

SWITCHING SPECIFICATIONS

AVDD = 1.8 V, DRVDD = 1.8 V, maximum sample rate, -1.0 dBFS differential input, 1.0 V internal reference, unless otherwise noted.

Table 4.

Parameter	Temperature	Min	Typ	Max	Unit
CLOCK INPUT PARAMETERS					
Input Clock Rate	Full	60		500	MHz
CLK Period (t_{CLK})	Full	2			Ns
CLK Pulse Width High (t_{CH})	Full		1		Ns
DATA OUTPUT PARAMETERS					
Data Propagation Delay (t_{PD})			3.7		ns
DCO Propagation Delay (t_{DCO})	Full		3.7		ns
DCO to Data Skew (t_{SKEW})	Full	-280	-60	100	ps
Pipeline Delay (Latency)	Full		11		Cycles
Aperture Delay (t_A)	Full		1.0		ns
Aperture Uncertainty (Jitter, t_j)	Full		0.1		ps rms
Wake-Up Time ¹	Full		500		μ s
OUT-OF-RANGE RECOVERY TIME	Full		4		Cycles

¹ Wake-up time is dependent on the value of the decoupling capacitors.

SPI TIMING SPECIFICATIONS

Table 5.

Parameter	Description	Min	Typ	Max	Unit
SPI TIMING REQUIREMENTS					
t_{DS}	Setup time between the data and the rising edge of SCLK	2			ns
t_{DH}	Hold time between the data and the rising edge of SCLK	2			ns
t_{CLK}	Period of the SCLK	40			ns
t_S	Setup time between CSB and SCLK	2			ns
t_H	Hold time between CSB and SCLK	2			ns
t_{HIGH}	SCLK pulse width high	10			ns
t_{LOW}	SCLK pulse width low	10			ns
t_{EN_SDIO}	Time required for the SDIO pin to switch from an input to an output relative to the SCLK falling edge	10			ns
t_{DIS_SDIO}	Time required for the SDIO pin to switch from an output to an input relative to the SCLK rising edge	10			ns

Timing Diagrams

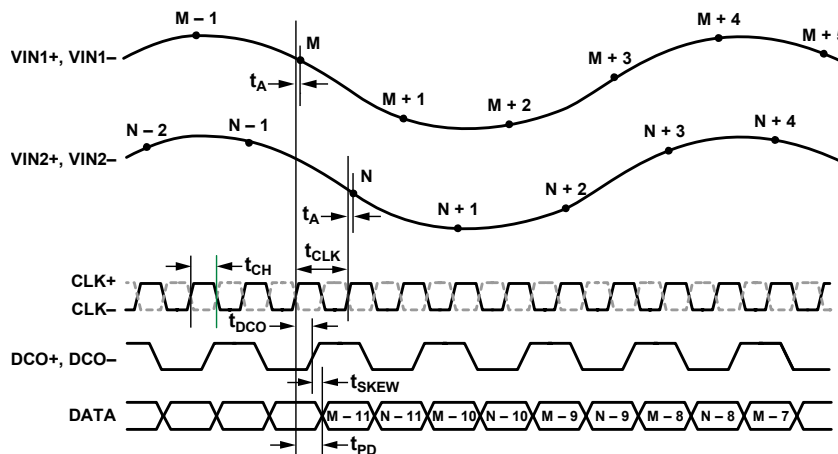

Figure 2. Output Timing Diagram, Sample Mode = Interleaved (Default)

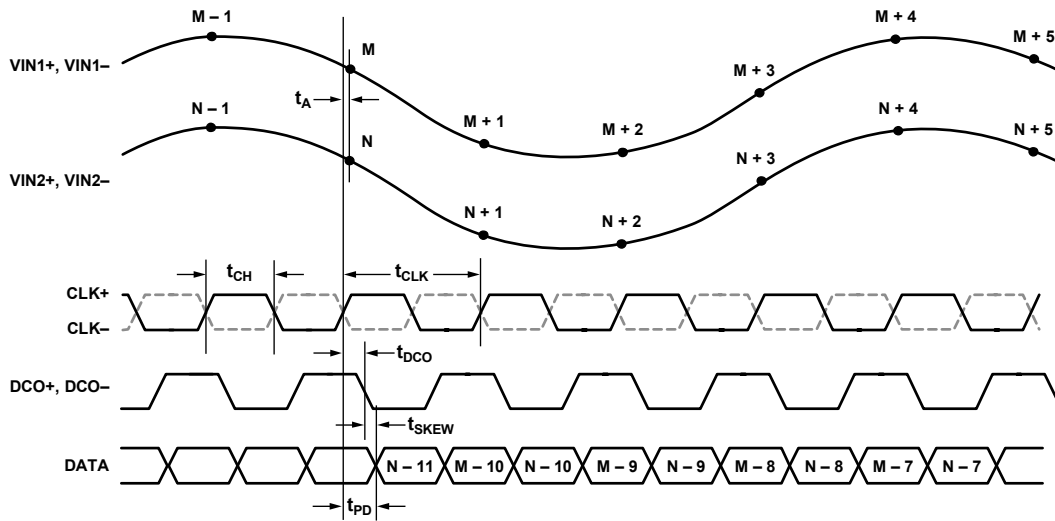

Figure 3. Output Timing Diagram, Sample Mode = Simultaneous, AUXCLKEN = 0

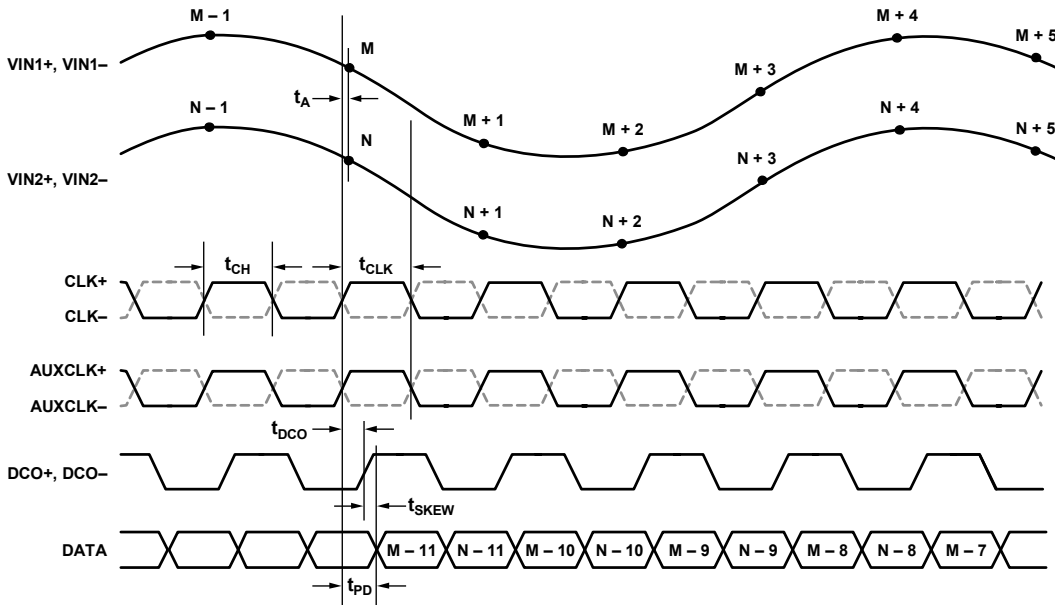

Figure 4. Output Timing Diagram, Sample Mode = Simultaneous, AUXCLKEN = 1, CLK and AUXCLK in Phase

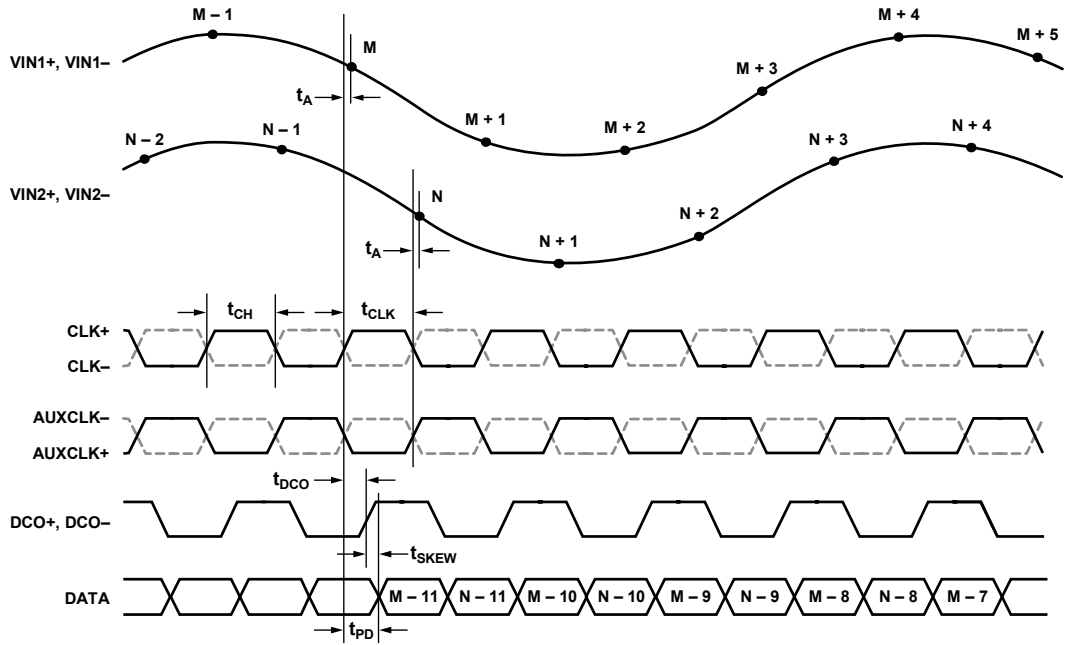

Figure 5. Output Timing Diagram, Sample Mode = Simultaneous, AUXCLKEN = 1, CLK and AUXCLK Out of Phase

09338-107

ABSOLUTE MAXIMUM RATINGS

Table 6.

Parameter	Rating
Electrical	
AVDD to AGND	−0.3 V to +2.0 V
DRVDD to DRGND	−0.3 V to +2.0 V
AGND to DRGND	−0.3 V to +0.3 V
AVDD to DRVDD	−2.0 V to +2.0 V
D0+/D0− through D7+/D7− to DRGND	−0.3 V to DRVDD + 0.3 V
DCO+, DCO− to DRGND	−0.3 V to DRVDD + 0.3 V
CLK+, CLK− to AGND	−0.3 V to AVDD + 0.2 V
AUXCLK+, AUXCLK− to AGND	−0.3 V to AVDD + 0.2 V
VIN1±, VIN2± to AGND	−0.3 V to AVDD + 0.2 V
SDIO/PWDN to DRGND	−0.3 V to DRVDD + 0.3 V
CSB to AGND	−0.3 V to DRVDD + 0.3 V
SCLK to AGND	−0.3 V to DRVDD + 0.3 V
Environmental	
Storage Temperature Range	−65°C to +125°C
Operating Temperature Range	−40°C to +85°C
Lead Temperature (Soldering, 10 sec)	300°C
Junction Temperature	150°C

Stresses at or above those listed under Absolute Maximum Ratings may cause permanent damage to the product. This is a stress rating only; functional operation of the product at these or any other conditions above those indicated in the operational section of this specification is not implied. Operation beyond the maximum operating conditions for extended periods may affect product reliability.

THERMAL RESISTANCE

θ_{JA} is specified for the worst-case conditions, that is, a device soldered in a circuit board for surface-mount packages.

Table 7. Thermal Resistance

Package Type	θ_{JA}	θ_{JC}	Unit
48-Lead LFCSP (CP-48-12)	30.4	2.9	°C/W

ESD CAUTION



ESD (electrostatic discharge) sensitive device. Charged devices and circuit boards can discharge without detection. Although this product features patented or proprietary protection circuitry, damage may occur on devices subjected to high energy ESD. Therefore, proper ESD precautions should be taken to avoid performance degradation or loss of functionality.

PIN CONFIGURATION AND FUNCTION DESCRIPTIONS

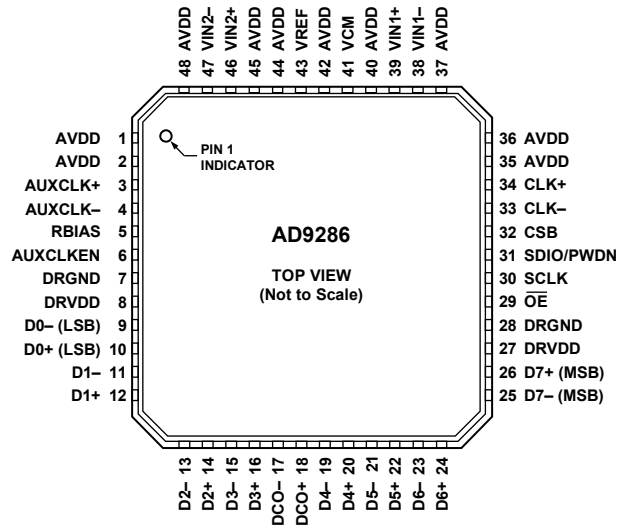

NOTES
 1. THE EXPOSED PADDLE MUST BE SOLDERED TO THE PCB ANALOG GROUND TO ENSURE PROPER FUNCTIONALITY AND HEAT DISSIPATION, NOISE, AND MECHANICAL STRENGTH BENEFITS.

00338-003

Figure 6. Pin Configuration

Table 8. Pin Function Descriptions

Pin No.	Mnemonic	Type	Description
ADC Power Pins			
1, 2, 35, 36, 37, 40, 42, 44, 45, 48	AVDD	Supply	Analog Power Supply (1.8 V Nominal).
8, 27	DRVDD	Supply	Digital Output Driver Supply (1.8 V Nominal).
7, 28	DRGND	Ground	Digital Output Ground.
0	AGND	Ground	Analog Ground. Pin 0 is the exposed thermal pad on the bottom of the package. This is the only ground connection, and it must be soldered to the PCB analog ground to ensure proper functionality and heat dissipation, noise, and mechanical strength benefits.
ADC Analog Pins			
39	VIN1+	Input	Differential Analog Input Pin (+) for Channel 1.
38	VIN1-	Input	Differential Analog Input Pin (-) for Channel 1.
46	VIN2+	Input	Differential Analog Input Pin (+) for Channel 2.
47	VIN2-	Input	Differential Analog Input Pin (-) for Channel 2.
43	VREF	Input/output	Voltage Reference Input/Output.
5	RBIAS	Input/output	External Reference Bias Resistor. Connect 10 kΩ from RBIAS to AGND.
41	VCM	Output	Common-Mode Level Bias Output for Analog Inputs.
34	CLK+	Input	ADC Clock Input—True.
33	CLK-	Input	ADC Clock Input—Complement.
3	AUXCLK+	Input	Auxiliary ADC Clock Input—True.
4	AUXCLK-	Input	Auxiliary ADC Clock Input—Complement.
Digital Inputs			
6	AUXCLKEN	Input	Auxiliary Clock Input Enable.
29	OE	Input	Digital Enable (Active Low) to Tristate Output Data Pins.
Digital Outputs			
26	D7+ (MSB)	Output	Output Data 7—True.
25	D7- (MSB)	Output	Output Data 7—Complement.
24	D6+	Output	Output Data 6—True.
23	D6-	Output	Output Data 6—Complement.
22	D5+	Output	Output Data 5—True.
21	D5-	Output	Output Data 5—Complement.

Pin No.	Mnemonic	Type	Description
20	D4+	Output	Output Data 4—True.
19	D4–	Output	Output Data 4—Complement.
16	D3+	Output	Output Data 3—True.
15	D3–	Output	Output Data 3—Complement.
14	D2+	Output	Output Data 2—True.
13	D2–	Output	Output Data 2—Complement.
12	D1+	Output	Output Data 1—True.
11	D1–	Output	Output Data 1—Complement.
10	D0+ (LSB)	Output	Output Data 0—True.
9	D0– (LSB)	Output	Output Data 0—Complement.
18	DCO+	Output	Data Clock Output—True.
17	DCO–	Output	Data Clock Output—Complement.
SPI Control Pins			
30	SCLK	Input	SPI Serial Clock.
31	SDIO/PWDN	Input/output	SPI Serial Data I/O (SDIO)/Power-Down Input in External Mode (PWDN).
32	CSB	Input	SPI Chip Select (Active Low).

TYPICAL PERFORMANCE CHARACTERISTICS

AVDD = 1.8 V, DRVDD = 1.8 V, sample rate = 500 MSPS, DCS enable, 1.2 V p-p differential input, VIN = -1.0 dBFS, 64k sample, TA = 25°C, unless otherwise noted.

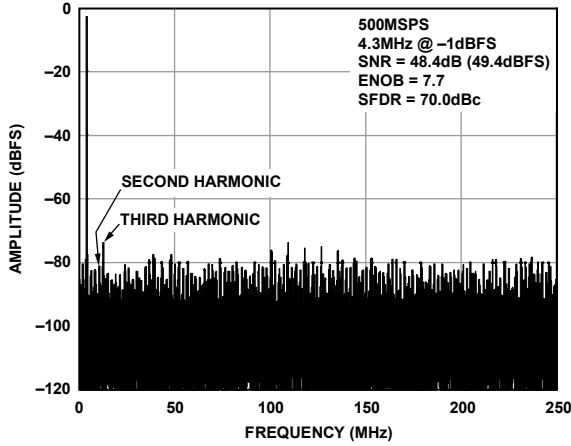

Figure 7. Single-Tone FFT with $f_{IN} = 4.3$ MHz

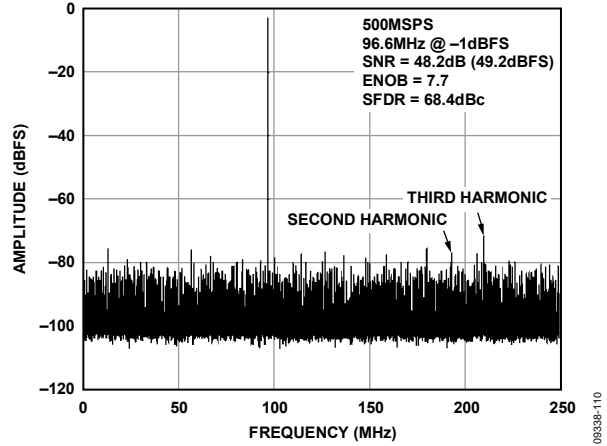

Figure 10. Single-Tone FFT with $f_{IN} = 96.6$ MHz

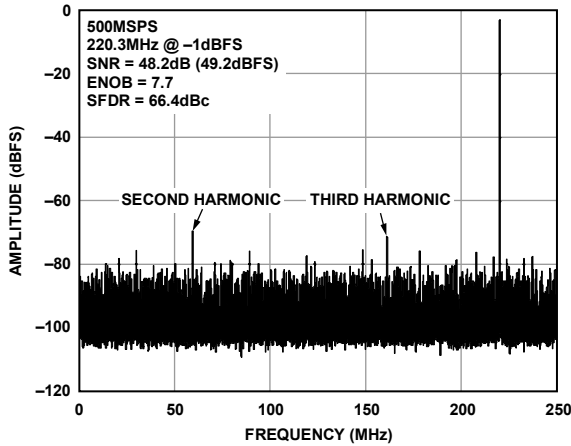

Figure 8. Single-Tone FFT with $f_{IN} = 220.3$ MHz

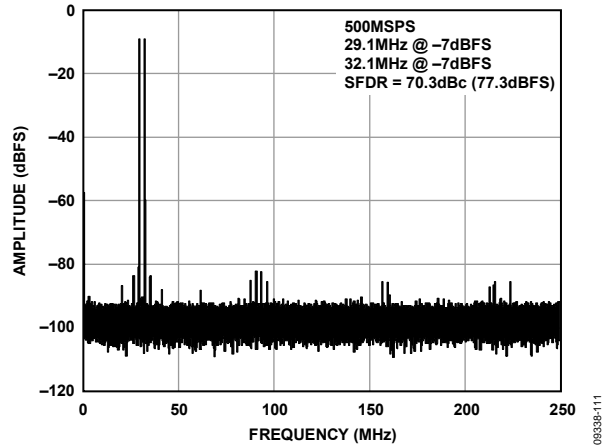

Figure 11. Two-Tone FFT with $f_{IN1} = 29.1$ MHz and $f_{IN2} = 32.1$ MHz

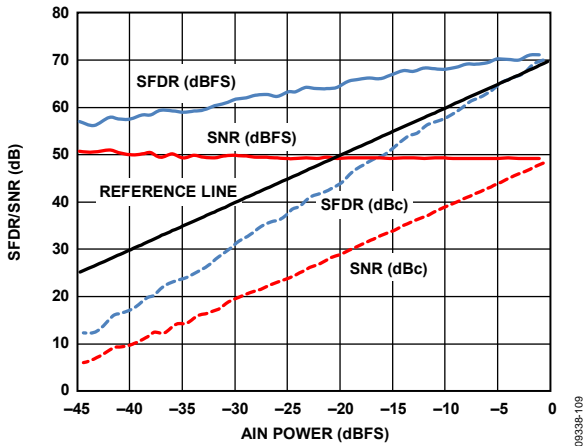

Figure 9. SFDR/SNR vs. Input Amplitude (AIN) with $f_{IN} = 2.2$ MHz

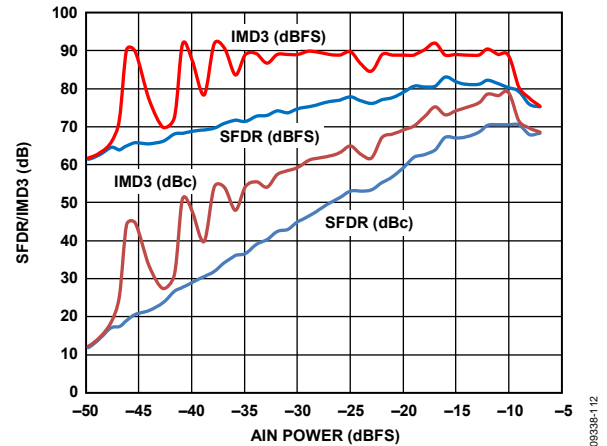

Figure 12. Two-Tone SFDR/IMD3 vs. Input Amplitude (AIN) with $f_{IN1} = 29.1$ MHz and $f_{IN2} = 32.1$ MHz

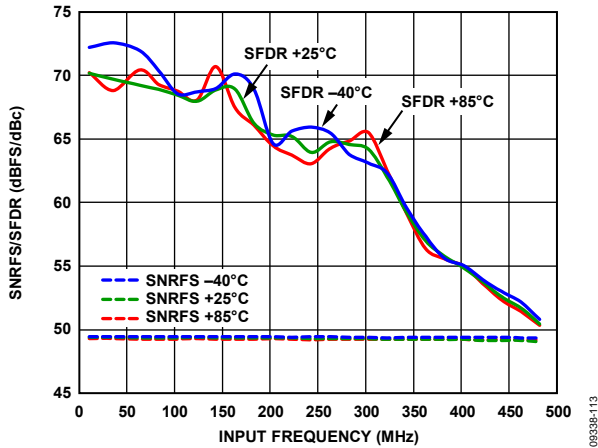

Figure 13. SNRFS/SFDR vs. Input Frequency (f_{IN}) and Temperature

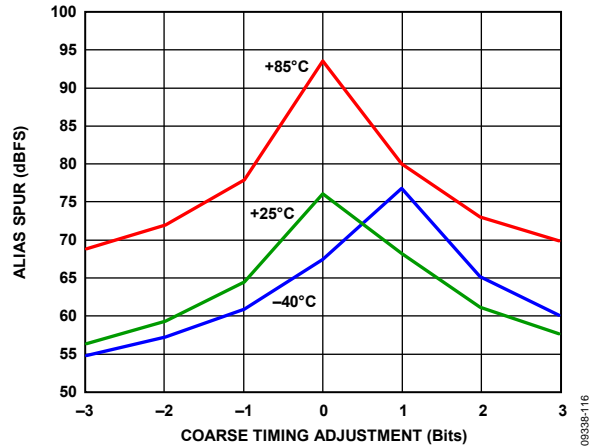

Figure 16. Alias Spur vs. Coarse Timing Adjustment and Temperature

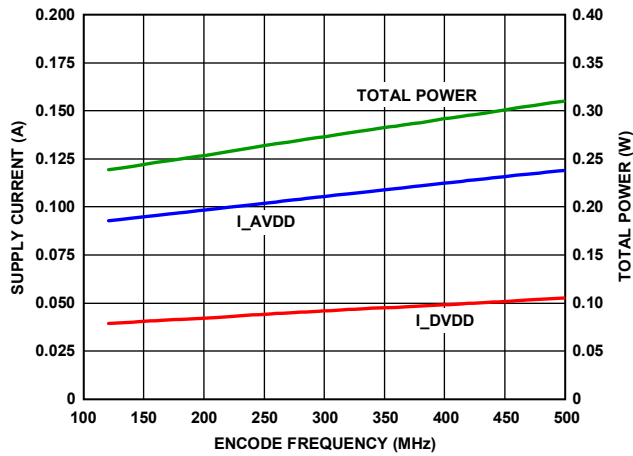

Figure 14. Supply Current and Power vs. Encode

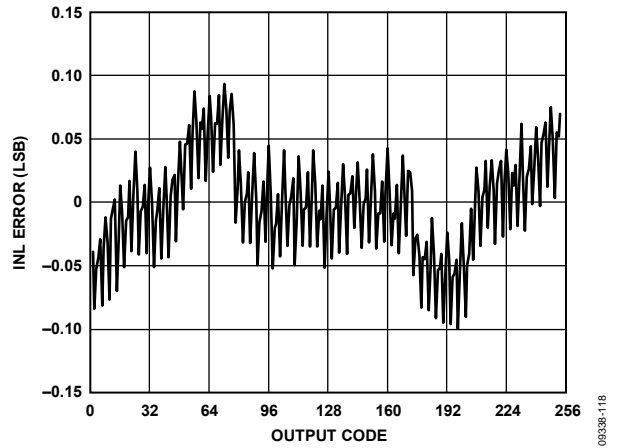

Figure 17. INL Error with $f_{IN} = 4.3$ MHz

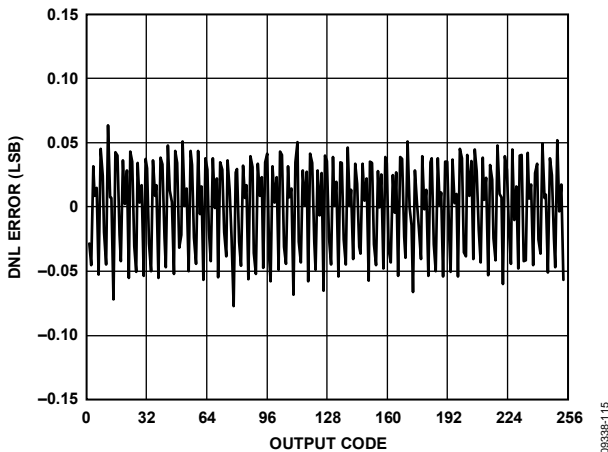

Figure 15. DNL Error with $f_{IN} = 4.3$ MHz

EQUIVALENT CIRCUITS

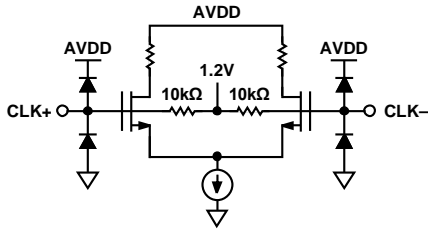

Figure 18. Clock Inputs

09338-019

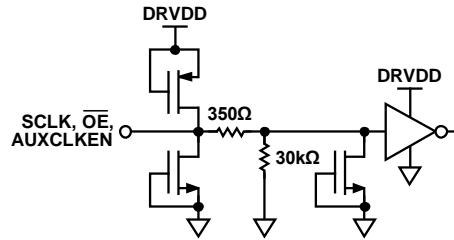

Figure 21. SCLK, \overline{OE} , AUXCLKEN

09338-022

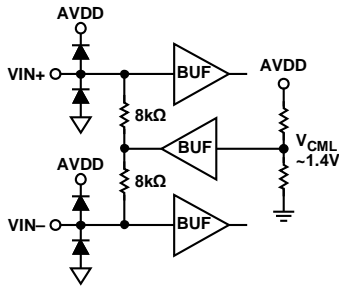

Figure 19. Analog Inputs ($V_{CML} \sim 1.4V$)

09338-020

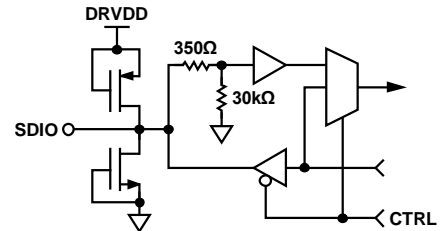

Figure 22. SDIO

09338-023

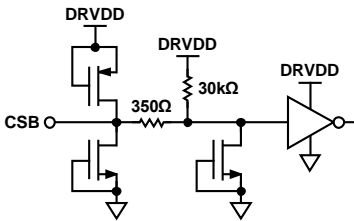

Figure 20. CSB

09338-021

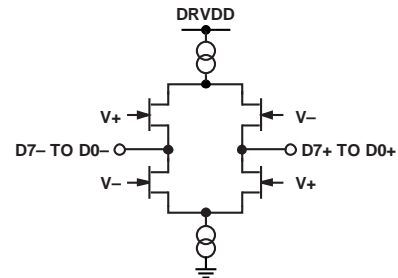

Figure 23. LVDS Output Driver

09338-024

THEORY OF OPERATION

The **AD9286** is a pipeline-type converter. The input buffers are differential, and both sets of inputs are internally biased. This allows the use of ac or dc input modes. A sample-and-hold amplifier is incorporated into the first stage of the multistage pipeline converter core. The output staging block aligns the data, carries out error correction for the pipeline stages, and feeds that data to the output interleave block and, finally, to the output buffers. All user-selected options are programmed through dedicated digital input pins or a serial port interface (SPI).

ADC ARCHITECTURE

Each interleaving channel of the **AD9286** consists of a differential input buffer followed by a sample-and-hold amplifier (SHA). This SHA is followed by a pipeline switched-capacitor ADC. The quantized outputs from each stage are combined into a final 8-bit result in the digital correction logic. The pipelined architecture permits the first stage to operate on a new input sample, whereas the remaining stages operate on preceding samples.

Each stage of the pipeline, excluding the last, consists of a low resolution flash ADC connected to a switched-capacitor DAC and interstage residue amplifier (MDAC). The residue amplifier magnifies the difference between the reconstructed DAC output and the flash input for the next stage in the pipeline. One bit of redundancy is used in each stage to facilitate digital correction of flash errors. The last stage consists of a flash ADC.

The input stage contains a differential SHA that can be ac- or dc-coupled in differential or single-ended mode. The output staging block aligns the data, carries out the error correction, and passes the data to the output buffers. The output buffers are powered from a separate supply, allowing adjustment of the output voltage swing. During power-down, the output buffers go into a high impedance state.

The outputs from both interleaving channels are time interleaved to achieve an effective 500 MSPS.

ANALOG INPUT CONSIDERATIONS

The analog inputs of the **AD9286** are differentially buffered. For best dynamic performance, the source impedances driving VIN1+, VIN1-, VIN2+, and VIN2- should be matched such that common-mode settling errors are symmetrical. Because the **AD9286** interleaves two ADC cores, special attention should be given, during board layout, to the symmetry of the two analog paths. Mismatch introduces undesired distortion. The analog inputs are optimized to provide superior wideband performance and must be driven differentially. SNR and SINAD performance degrades significantly if the analog inputs are driven with a single-ended signal.

A wideband transformer, such as Mini-Circuits® ADT1-1WT, can provide the differential analog inputs for applications that require a single-ended-to-differential conversion. Both analog inputs are self-biased by an on-chip resistor divider to a nominal 1.4 V.

Differential Input Configurations

Optimum performance is achieved when driving the **AD9286** in a differential input configuration. For baseband applications, the **ADA4937-1** differential driver provides excellent performance and a flexible interface to the ADC (see Figure 24). The output common-mode voltage of the **AD9286** is easily set to 1.4 V, and the driver can be configured in a Sallen-Key filter topology to provide band limiting of the input signal.

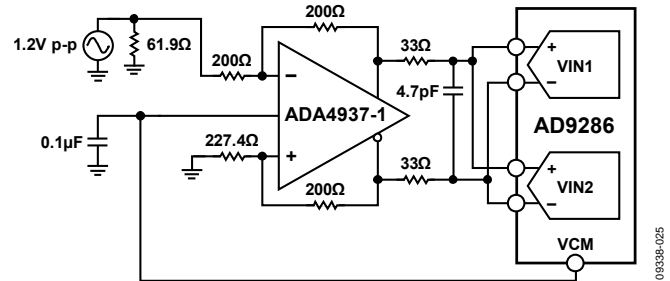

Figure 24. Differential Input Configuration Using the **ADA4937-1**

The **AD9286** can also be driven passively with a differential transformer-coupled input (see Figure 25). To bias the analog input, the VCM voltage can be connected to the center tap of the secondary winding of the transformer.

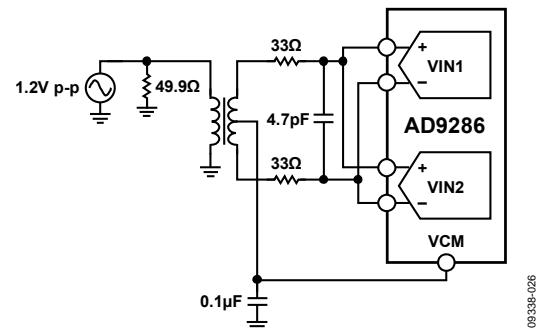

Figure 25. Differential Transformer-Coupled Configuration

The signal characteristics must be considered when selecting a transformer. Most RF transformers saturate at frequencies below a few megahertz (MHz). Excessive signal power can also cause core saturation, which leads to distortion.

VOLTAGE REFERENCE

An internal differential voltage reference creates positive and negative reference voltages that define the 1.2 V p-p fixed span of the ADC core. This internal voltage reference can be adjusted by means of SPI control. It can also be driven externally with an off-chip stable reference. See the Memory Map Register Descriptions section for more details.

RBIAS

The **AD9286** requires the user to place a 10 kΩ resistor between the RBIAS pin and ground. This resistor, which is used to set the master current reference of the ADC core, should have a 1% tolerance.

CLOCK INPUT CONSIDERATIONS

For optimum performance, clock the [AD9286](#) sample clock inputs, CLK+ and CLK- (and, optionally, AUXCLK+ and AUXCLK-), with a differential signal. The signal is typically ac-coupled into the CLK+ and CLK- pins via a transformer or capacitors.

Clock Input Options

The [AD9286](#) has a very flexible clock input structure. The clock input can be an LVDS, LVPECL, or sine wave signal. Each configuration that is described in this section applies to both CLK+ and CLK- and AUXCLK+ and AUXCLK-, when necessary.

Figure 26 and Figure 27 show two preferred methods for clocking the [AD9286](#). A low jitter clock source is converted from a single-ended signal to a differential signal using either an RF transformer or an RF balun. The back-to-back Schottky diodes across the transformer/balun secondary limit clock excursions into the [AD9286](#) to approximately 0.8 V p-p differential.

This limit helps prevent the large voltage swings of the clock from feeding through to other portions of the [AD9286](#), while preserving the fast rise and fall times of the signal that are critical to low jitter performance.

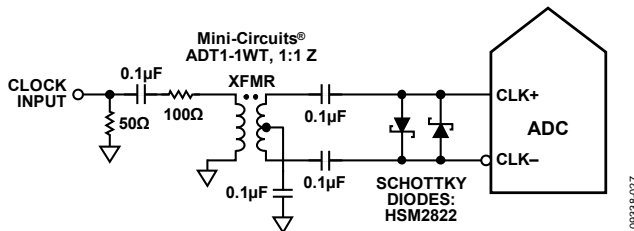

Figure 26. Transformer-Coupled Differential Clock

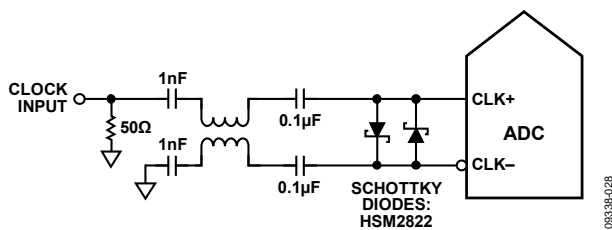

Figure 27. Balun-Coupled Differential Clock

If a low jitter clock source is not available, another option is to ac couple a differential PECL signal to the sample clock input pins, as shown in Figure 28. The [AD9510/AD9511/AD9512/AD9513/AD9514/AD9515/AD9516/AD9517](#) clock drivers offer excellent jitter performance.

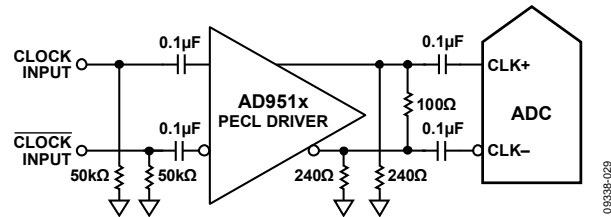

Figure 28. Differential PECL Sample Clock

A third option is to ac couple a differential LVDS signal to the sample clock input pins, as shown in Figure 29. The [AD9510/AD9511/AD9512/AD9513/AD9514/AD9515/AD9516/AD9517](#) clock drivers offer excellent jitter performance.

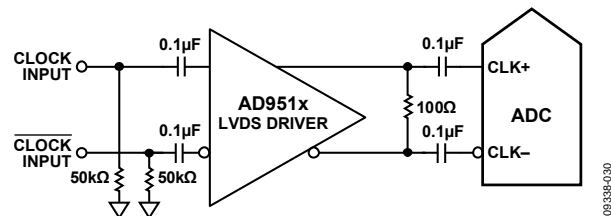

Figure 29. Differential LVDS Sample Clock

Clocking Modes

The [AD9286](#) powers up as a single-channel converter with interleaving enabled. In this mode, a single high speed clock, driving CLK+ and CLK-, is divided down into two half-speed clocks running 180° out of phase with each other, each driving their respective ADC core. By strapping the two analog inputs together externally, the [AD9286](#) operates as a single 500 MSPS ADC.

Because the high sample rate is achieved by interleaving two ADC cores, mismatch between the cores, board layout, and clock timing can cause unwanted distortion. The [AD9286](#) has been designed with two well-matched ADC cores to minimize mismatch. To aid the user in removing timing errors, the [AD9286](#) provides both fine and coarse timing adjustments, per channel, through SPI. These features are available at Register 0x37 (fine) and Register 0x38 (coarse).

The [AD9286](#) supports a mode that allows the user to provide two separate half-speed clocks, bypassing the internal clock timing circuits and permitting external control of the clock timing relationship for each interleave channel. When the sample mode is set to simultaneous (Address 0x09, Bit 3 = 1) and the AUXCLKEN pin is tied to DRVDD, the [AD9286](#) expects a second clock on its auxiliary clock input (AUXCLK+, AUXCLK-).

In this mode, the AD9286 can also function as a dual 8-bit, 250 MSPS converter. This may be useful in applications where both a single 8-bit, 500 MSPS and a dual 8-bit, 250 MSPS converter are needed. The clock management block requires that CLK± and AUXCLK± be either 0° or 180°, relative to each other. If this requirement is satisfied, the circuit correctly time aligns the data coming out of each ADC core.

If the user desires to operate the AD9286 as a dual 8-bit, 250 MSPS converter and supply only a single clock, this is achieved by setting sample mode to simultaneous, with the AUXCLKEN pin tied to AGND. In this mode, the two ADC cores sample simultaneously. For a summary of all supported clocking modes, see Table 9.

The AD9286 supports the clocking of each internal ADC with separate clocks. By setting AUXCLKEN to DRVDD, the user can supply a differential auxiliary clock to AUXCLK+ and AUXCLK-. In this mode, each internal ADC core has a maximum sample rate of 250 MSPS. This mode bypasses the internal timing adjustment blocks.

Interleave Performance

The AD9286 achieves 500 MSPS conversion by time interleaving two 250 MSPS ADC channels. Although this technique is sufficient in achieving 8-bit performance, quantifiable errors are introduced. These errors come from three sources: gain mismatch, imperfect out-of-phase sampling, and offset mismatch between the two channels. Distortion appears spectrally in two distinct ways: gain and timing mismatch appear as an alias spur (see Equation 1), and offset mismatch appears as a spur located at the Nyquist rate of the converter (see Equation 2).

$$f_{ALIAS_SPUR} = f_s/2 - f_{IN} \tag{1}$$

where:

f_s is the interleaved sample rate.

f_{IN} is the analog input frequency.

$$f_{OFFSET_SPUR} = f_s/2 \tag{2}$$

where f_s is the interleaved sample rate.

The magnitude of the alias spur (AS) contributed by a gain error is shown in Equation 3.

$$AS_{GAIN} \text{ (dBc)} = 20 \times \log(AS_{GAIN}) = 20 \times \log(G_E/2) \tag{3}$$

where:

$$G_E = \text{Gain_Error_Ratio} = 1 - V_{FS1}/V_{FS2}$$

V_{FSn} is the full-scale voltage of Core n .

Table 9. Supported Clocking Modes

Effective Number of Channels	Maximum CLK Frequency	AUXCLK Frequency	AUXCLK Phase Relative to CLK	AUXCLKEN	SPI Register, Address 0x09, Bit 3	Clock Timing Adjust
One	500 MSPS	N/A	N/A	Low	0	Internal
Two	250 MSPS	N/A	N/A	Low	1	N/A
Two	250 MSPS	CLK	0°	High	1	N/A
One	250 MSPS	CLK	180°	High	1	External

AS_{GAIN} , as a function of gain mismatch, is shown in Figure 30.

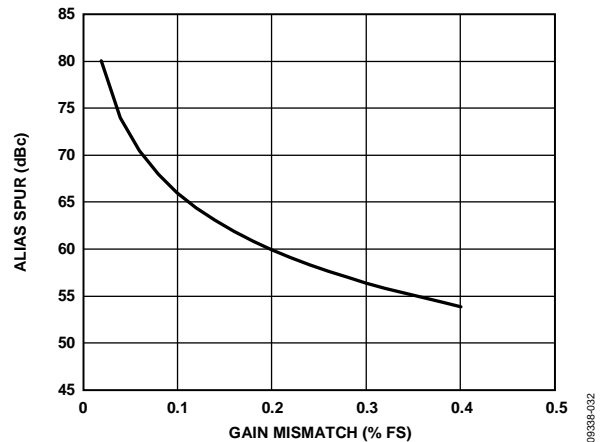

Figure 30. AS_{GAIN} as a Function of Gain Mismatch

The magnitude of the alias spur (AS) contributed by a timing error is shown in Equation 4.

$$AS_{TIMING} \text{ (dBc)} = 20 \times \log(AS_{TIMING}) = 20 \times \log(\theta_{EP}/2) \tag{4}$$

where $\theta_{EP} = \omega_A \times \Delta t_E$ (Radians), with ω_A as the analog input frequency and Δt_E as the clock skew error.

AS_{TIMING} , as a function of timing error, is shown in Figure 31.

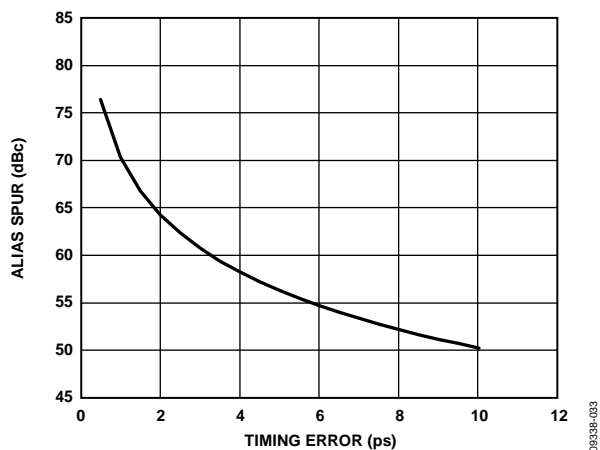

Figure 31. AS_{TIMING} as a Function of Timing Error

The total magnitude of the alias spur (AS) is shown in Equation 5.

$$AS_{TOTAL} \text{ (dB)} = 20 \times \log\sqrt{(AS_{GAIN})^2 + (AS_{TIMING})^2} \tag{5}$$

The magnitude of the offset spur (OS) is shown in Equation 6.

$$OS_{\text{OFFSET}} \text{ (dBFS)} = 20 \times \log(\text{OFFSET} \times 2/2^{\text{RESOLUTION}}) \quad (6)$$

where:

OFFSET is the channel-to-channel offset in codes.

RESOLUTION is the resolution of the converter (eight bits).

OS_{OFFSET} , as a function of offset mismatch, is shown in Figure 32.

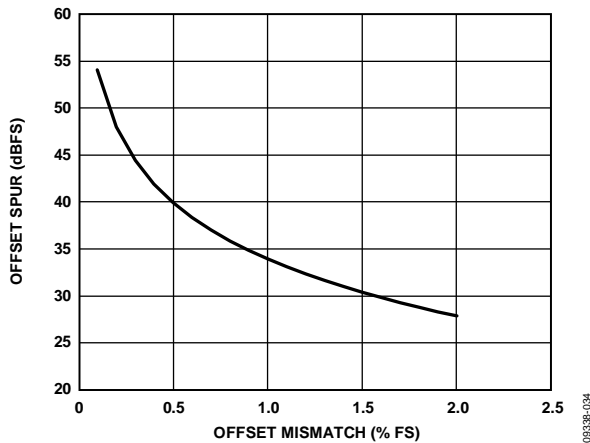

Figure 32. OS_{OFFSET} as a Function of Offset Mismatch

Due to the orthogonal relationship between the gain and timing errors, it is impossible to correct for one with the other. To minimize channel-to-channel gain error, the AD9286 is designed to have very close gain matching between the two channels. Address 0x37 and Address 0x38 of the SPI provide the ability to add delay to either clock path to realize a minimum clock skew error. Also provided via the SPI, in Address 0x10, is the ability to minimize the channel-to-channel offset error.

DIGITAL OUTPUTS

Digital Output Enable Function (\overline{OE})

The AD9286 has a flexible three-state ability for the digital output pins. The three-state mode is enabled using the \overline{OE} pin. When \overline{OE} is set to logic level high, the output drivers for both data buses are placed into a high impedance state.

BUILT-IN SELF-TEST (BIST) AND OUTPUT TEST

The [AD9286](#) includes a built-in self-test feature that is designed to enable verification of the integrity of each channel, as well as facilitate board level debugging. A built-in self-test (BIST) feature that verifies the integrity of the digital datapath of the [AD9286](#) is included. Various output test options are also provided to place predictable values on the outputs of the [AD9286](#).

BUILT-IN SELF-TEST (BIST)

The BIST is a thorough test of the digital portion of the selected [AD9286](#) signal path. Perform the BIST test after a reset to ensure that the part is in a known state. During BIST, data from an internal pseudorandom noise (PN) source is driven through the digital datapath of both channels, starting at the ADC block output. At the datapath output, CRC logic calculates a signature from the data. The BIST sequence runs for 512 cycles and then stops. When the test is completed, the BIST compares the signature results with a predetermined value. If the signatures match, the BIST sets Bit 0 of Register 0x0E, signifying that the test passed. If the BIST test fails, Bit 0 of Register 0x0E is cleared. The outputs are connected during this test, so the PN sequence can be observed as it runs.

Writing a value of 0x05 to Register 0x0E runs the BIST. This enables the Bit 0 (BIST enable) of Register 0x0E and resets the PN sequence generator, Bit 2 (BIST init) of Register 0x0E. At the completion of the BIST, Bit 0 of Register 0x0E is automatically cleared. The PN sequence can be continued from its last value by writing a 0 to Bit 2 of Register 0x0E. However, if the PN sequence is not reset, the signature calculation does not equal the predetermined value at the end of the test. At that point, the user must rely on verifying the output data.

OUTPUT TEST MODES

The output test options are described in Table 13 at Address 0x0D. When an output test mode is enabled, the analog section of the ADC is disconnected from the digital back-end blocks and the test pattern is run through the output formatting block. Some test patterns are subject to output formatting, and some are not. The PN generators from the PN sequence tests can be reset by setting Bit 4 or Bit 5 of Register 0x0D. These tests can be performed with or without an analog signal (if present, the analog signal is ignored), but they do require an encode clock. For more information, see the [AN-877 Application Note, Interfacing to High Speed ADCs via SPI](#).

SERIAL PORT INTERFACE (SPI)

The AD9286 serial port interface (SPI) allows the user to configure the converter for specific functions or operations through a structured register space provided inside the ADC. The SPI gives the user added flexibility and customization, depending on the application. Addresses are accessed via the serial port and can be written to or read from via the port. Memory is organized into bytes that can be further divided into fields, which are documented in the Memory Map section. For detailed operational information, see the [AN-877 Application Note, Interfacing to High Speed ADCs via SPI](#).

CONFIGURATION USING THE SPI

Three pins define the SPI of this ADC: SCLK, SDIO, and CSB (see Table 10). SCLK (a serial clock) is used to synchronize the read and write data presented from and to the ADC. SDIO (serial data input/output) is a dual-purpose pin that allows data to be sent to and read from the internal ADC memory map registers. CSB (chip select bar) is an active low control that enables or disables the read and write cycles.

Table 10. Serial Port Interface Pins

Pin	Function
SCLK	Serial clock. A serial shift clock input that is used to synchronize serial interface reads and writes.
SDIO	Serial data input/output. A dual-purpose pin that typically serves as an input or an output, depending on the instruction being sent and the relative position in the timing frame.
CSB	Chip select bar. An active low control that gates the read and write cycles.

The falling edge of CSB, in conjunction with the rising edge of SCLK, determines the start of the framing. An example of the serial timing and its definitions can be found in Figure 33.

Other modes involving CSB are available. The CSB pin can be held low indefinitely, which permanently enables the device; this is called streaming. CSB can stall high between bytes to allow for additional external timing. When the CSB pin is tied high, SPI functions are placed in high impedance mode. This mode turns on any SPI pin secondary functions.

During the instruction phase, a 16-bit instruction is transmitted. Data follows the instruction phase, and its length is determined by the W0 and W1 bits, as shown in Figure 33.

All data is composed of 8-bit words. The first bit of the first byte in a multibyte serial data transfer frame indicates whether a read command or a write command is issued. This allows the serial data input/output (SDIO) pin to change direction, from an input to an output, at the appropriate point in the serial frame.

In addition to word length, the instruction phase determines whether the serial frame is a read or write operation, allowing the serial port to be used both to program the chip and to read the contents of the on-chip memory. If the instruction is a readback operation, the serial data input/output (SDIO) pin changes direction, from an input to an output, at the appropriate point in the serial frame.

Data can be sent in MSB-first mode or in LSB-first mode. MSB first is the default on power-up and can be changed via the SPI port configuration register. For more information about this and other features, see the [AN-877 Application Note, Interfacing to High Speed ADCs via SPI](#).

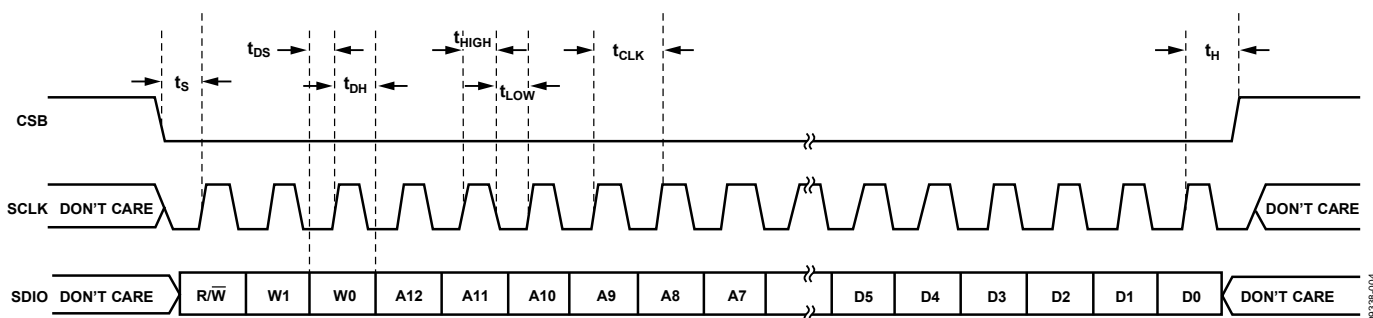

Figure 33. Serial Port Interface Timing Diagram

HARDWARE INTERFACE

The pins described in Table 10 constitute the physical interface between the programming device of the user and the serial port of the AD9286. The SCLK and CSB pins function as inputs when using the SPI interface. The SDIO pin is bidirectional, functioning as an input during write phases and as an output during readback.

The SPI interface is flexible enough to be controlled by either FPGAs or microcontrollers. One method for SPI configuration is described in detail in the [AN-812 Application Note, Micro-controller-Based Serial Port Interface \(SPI\) Boot Circuit](#).

The SPI port should not be active during periods when the full dynamic performance of the converter is required. Because the SCLK, CSB, and SDIO signals are typically asynchronous to the ADC clock, noise from these signals can degrade converter performance. If the on-board SPI bus is used for other devices, it may be necessary to provide buffers between this bus and the AD9286 to prevent these signals from transitioning at the converter inputs during critical sampling periods.

SDIO/PWDN serves a dual function when the SPI interface is not being used. When the pin is strapped to AVDD or ground during device power-on, it is associated with a specific function. The mode selection table (see Table 11) describes the strappable functions that are supported on the AD9286.

Table 11. Mode Selection

Pin	External Voltage	Configuration
SDIO/PWDN	AVDD (default)	Chip in full power-down
	AGND	Normal operation
$\overline{\text{OE}}$	AVDD	Outputs in high impedance
	AGND (default)	Outputs enabled

CONFIGURATION WITHOUT THE SPI

In applications that do not interface to the SPI control registers, the SDIO/PWDN pin serves as a standalone, CMOS-compatible control pin. When the device is powered up, it is assumed that the user intends to use the SDIO, SCLK, and CSB pins as static control lines for the output enable and power-down feature control. In this mode, connecting the CSB chip select to AVDD disables the serial port interface.

SPI ACCESSIBLE FEATURES

Table 12 provides a brief description of the general features that are accessible via the SPI. These features are described in detail in the [AN-877 Application Note, Interfacing to High Speed ADCs via SPI](#). The AD9286 part-specific features are described in detail in Table 13.

Table 12. Features Accessible Using the SPI

Feature	Description
Mode	Allows the user to set either power-down mode or standby mode
Clock Offset	Allows the user to access the DCS via the SPI
Test I/O	Allows the user to digitally adjust the converter offset
Output Mode	Allows the user to set test modes to have known data on output bits
Output Phase	Allows the user to set up outputs
Output Delay	Allows the user to set the output clock polarity
Voltage Reference	Allows the user to vary the DCO delay
	Allows the user to set the voltage reference

MEMORY MAP

READING THE MEMORY MAP REGISTER TABLE

Each row in the memory map register table (see Table 13) has eight bit locations. The memory map is roughly divided into three sections: the chip configuration registers (Address 0x00 to Address 0x02), the device index and transfer registers (Address 0x05 and Address 0xFF), and the program registers (Address 0x08 to Address 0x38).

Table 13 documents the default hexadecimal value for each hexadecimal address shown. The column with the heading Bit 7 (MSB) is the start of the default hexadecimal value given. For more information on this function and others, see the [AN-877 Application Note, Interfacing to High Speed ADCs via SPI](#). This document details the functions controlled by Register 0x00 to Register 0xFF.

Open Locations

All address and bit locations that are not included in the SPI map are not currently supported for this device. Unused bits of a valid address location should be written with 0s. Writing to these locations is required only when part of an address location is open. If the entire address location is open, it is omitted from the SPI map (for example, Address 0x13) and should not be written.

Default Values

After the [AD9286](#) is reset, critical registers are loaded with default values. The default values for the registers are given in the memory map register table (see Table 13).

Logic Levels

An explanation of logic level terminology follows:

- “Bit is set” is synonymous with “bit is set to Logic 1” or “writing Logic 1 for the bit.”
- “Bit is cleared” is synonymous with “bit is set to Logic 0” or “writing Logic 0 for the bit.”

Transfer Register Map

Address 0x08 to Address 0x38 are shadowed. Writes to these addresses do not affect part operation until a transfer command is issued by writing 0x01 to Address 0xFF, setting the transfer bit. Setting the transfer bit allows these registers to be updated internally and simultaneously. The internal update takes place when the transfer bit is set, and then the bit autoclears.

Channel-Specific Registers

Some channel setup functions can be programmed differently for each channel. In these cases, channel address locations are internally duplicated for each channel. These registers and bits are designated in the memory map register table as local. These local registers and bits can be accessed by setting the appropriate Channel 1 (Bit 0) or Channel 2 (Bit 1) bits in Register 0x05.

If both bits are set, the subsequent write affects the registers of both channels. In a read cycle, set only Channel 1 or Channel 2 to read one of the two registers. If both bits are set during an SPI read cycle, the part returns the value for Channel 1. Registers and bits designated as global in the memory map register table affect the entire part or the channel features for which independent settings are not allowed between channels. The settings in Register 0x05 do not affect the global registers and bits.

MEMORY MAP REGISTER TABLE

All address and bit locations that are not included in Table 13 are not currently supported for this device.

Table 13. Memory Map Registers

Addr (Hex)	Register Name	Bit 7 (MSB)	Bit 6	Bit 5	Bit 4	Bit 3	Bit 2	Bit 1	Bit 0 (LSB)	Default Value (Hex)	Default Notes/Comments
Chip Configuration Registers											
0x00	SPI port configuration	0	LSB first	Soft reset	1	1	Soft reset	LSB first	0	0x18	Nibbles are mirrored so that LSB-first or MSB-first mode registers correctly, regardless of shift mode
0x01	Chip ID (global)	8-bit chip ID								0x0A	Unique chip ID used to differentiate devices; read only
0x02	Chip grade (global)	Open	Speed grade ID 100 = 500 MSPS			Open			0x40	Unique speed grade ID used to differentiate devices; read only	
Device Index and Transfer Registers											
0x05	Device Index A	Open						ADC 2 default	ADC 1 default	0xFF	Bits are set to determine which on-chip device receives the next write command; default is all devices on the chip
0xFF	Transfer	Open						Transfer		0xFF	Synchronous transfer of data from the master shift register to the slave
Program Registers (May or may not be indexed by device index)											
0x08	Modes (global)	Open				Internal power-down mode 00: chip run 01: full power-down 10: reserved 11: reserved			0x00	Determines various generic modes of chip operation	
0x09	Clock (global)	Open			Sample mode 0: interleaved 1: simultaneous	Open	Clock boost	Duty cycle stabilizer	0x09		
0x0D	Test mode (local)	Open	Reset PN23 gen	Reset PN9 gen	Open	Output test mode 000: off 001: midscale short 010: +FS short 011: -FS short 100: checkerboard output 101: PN23 sequence 110: PN9 sequence 111: one-/zero-word toggle			0x00	When test mode is set, test data is placed on the output pins in place of normal data	
0x0E	BIST (local)	Open				BIST init	Open	BIST enable	0x00	BIST mode config	

Addr (Hex)	Register Name	Bit 7 (MSB)	Bit 6	Bit 5	Bit 4	Bit 3	Bit 2	Bit 1	Bit 0 (LSB)	Default Value (Hex)	Default Notes/ Comments
0x0F	ADC input (global/local)	Open					Analog disconnect (local)	Common-mode input enable (global)	Open	0x02	
0x10	Offset (local)	Open				Offset adjust (twos complement format) 0111: +7 0110: +6 ... 0001: +1 0000: 0 1111: -1 ... 1001: -7 1000: -8				0x00	Device offset trim
0x14	Output mode (local)	Open			Output enable	Open	Output invert	Data format select 00: offset binary 01: twos complement 10: Gray code 11: reserved		0x00	Configures the outputs and the format of the data
0x16	Output phase (global)	DCO invert	Open						0x00		
0x18	Voltage reference (global)	Open			Voltage reference and input full-scale adjustment (see Table 14)				0x00	Selects/adjusts V_{REF}	
0x24	MISR LSB (local)	LSBs of multiple input shift register (MISR)								0x00	MISR least significant byte; read only
0x25	MISR MSB (local)	MSBs of multiple input shift register (MISR)								0x00	MISR most significant byte; read only
0x37	Timing adjust (local)	Open				Fine timing skew 0000: 0.0 ps 0001: 0.075 ps ... 1111: 1.125 ps				0x00	Determines the clock delay that is introduced into the sampling path
0x38		Open				Coarse timing skew 0000: 0.0 ps 0001: 1.2 ps ... 1111: 18 ps				0x00	Determines the clock delay that is introduced into the sampling path

MEMORY MAP REGISTER DESCRIPTIONS

For more information about functions controlled in Register 0x00 to Register 0xFF, see the [AN-877 Application Note, Interfacing to High Speed ADCs via SPI](#).

Voltage Reference (Register 0x18)

Bits[7:5]—Reserved

Bits[4:0]—Voltage Reference

Bits[4:0] scale the internally generated voltage reference and, consequently, the full scale of the analog input. Within this register, the reference driver can be configured to be more easily driven externally by reducing the capacitive loading.

The relationship between the V_{REF} voltage and the input full scale is described by Equation 7. See Table 14 for a complete list of register settings.

$$Input_Full_Scale = V_{REF} \times 1.2 \quad (7)$$

Table 14. V_{REF} and Input Full Scale (Register 0x18)

Value	V_{REF} (V)	Full Scale (V)
0x14	0.844	1.013
0x15	0.857	1.028
0x16	0.87	1.044
0x17	0.883	1.060
0x18	0.896	1.075
0x19	0.909	1.091
0x1A	0.922	1.106
0x1B	0.935	1.122
0x1C	0.948	1.138
0x1D	0.961	1.153
0x1E	0.974	1.169
0x1F	0.987	1.184
0x00	1	1.200
0x01	1.013	1.216
0x02	1.026	1.231
0x03	1.039	1.247
0x04	1.052	1.262
0x05	1.065	1.278
0x06	1.078	1.294
0x07	1.091	1.309
0x08	1.104	1.325
0x09	1.117	1.340
0x0A	1.13	1.356
0x0B	1.143	1.372
0x0C	1.156	1.387
0x0D	1.169	1.403
0x0E	1.182	1.418
0x0F	1.195	1.434
0x10	1.208	1.450
0x11	1.221	1.465
0x12	1.234	1.481
0x13	External	External \times 1.2

APPLICATIONS INFORMATION

DESIGN GUIDELINES

Before starting design and layout of the [AD9286](#) as a system, it is recommended that the designer become familiar with these guidelines, which discuss the special circuit connections and layout requirements that are needed for certain pins.

Power and Ground Recommendations

When connecting power to the [AD9286](#), it is strongly recommended that two separate supplies be used. Use one 1.8 V supply for analog (AVDD); use a separate 1.8 V supply for the digital output supply (DRVDD). If a common 1.8 V AVDD and DRVDD supply must be used, the AVDD and DRVDD domains must be isolated with a ferrite bead or filter choke and separate decoupling capacitors. Several different decoupling capacitors can be used to cover both high and low frequencies. Locate these capacitors close to the point of entry at the printed circuit board (PCB) level and close to the pins of the part, with minimal trace length.

A single PCB ground plane should be sufficient when using the [AD9286](#). With proper decoupling and smart partitioning of the PCB analog, digital, and clock sections, optimum performance is easily achieved.

Exposed Paddle Thermal Heat Sink Recommendations

The exposed paddle (Pin 0) is the only ground connection for the [AD9286](#); therefore, it must be connected to analog ground (AGND) on the customer PCB. To achieve the best electrical and thermal performance, mate an exposed (no solder mask), continuous copper plane on the PCB to the [AD9286](#) exposed paddle, Pin 0.

The copper plane should have several vias to achieve the lowest possible resistive thermal path for heat dissipation to flow through the bottom of the PCB. Fill or plug these vias with nonconductive epoxy.

To maximize the coverage and adhesion between the ADC and the PCB, a silkscreen should be overlaid to partition the continuous plane on the PCB into several uniform sections. This provides several tie points between the ADC and the PCB during the reflow process. Using one continuous plane with no partitions guarantees only one tie point between the ADC and the PCB. For detailed information about packaging and PCB layout of chip scale packages, see the [AN-772 Application Note, A Design and Manufacturing Guide for the Lead Frame Chip Scale Package \(LFCSPP\)](#), at www.analog.com.

VCM

The VCM pin should be decoupled to ground with a 0.1 μF capacitor.

RBIAS

The [AD9286](#) requires that a 10 k Ω resistor be placed between the RBIAS pin and ground. This resistor, which sets the master current reference of the ADC core, should have at least a 1% tolerance.

Reference Decoupling

Decouple the VREF pin externally to ground with a low ESR, 1.0 μF capacitor in parallel with a low ESR, 0.1 μF ceramic capacitor.

SPI Port

The SPI port should not be active during periods when the full dynamic performance of the converter is required. Because the SCLK, CSB, and SDIO signals are typically asynchronous to the ADC clock, noise from these signals can degrade converter performance. If the on-board SPI bus is used for other devices, it may be necessary to provide buffers between this bus and the [AD9286](#) to prevent these signals from transitioning at the converter inputs during critical sampling periods.

OUTLINE DIMENSIONS

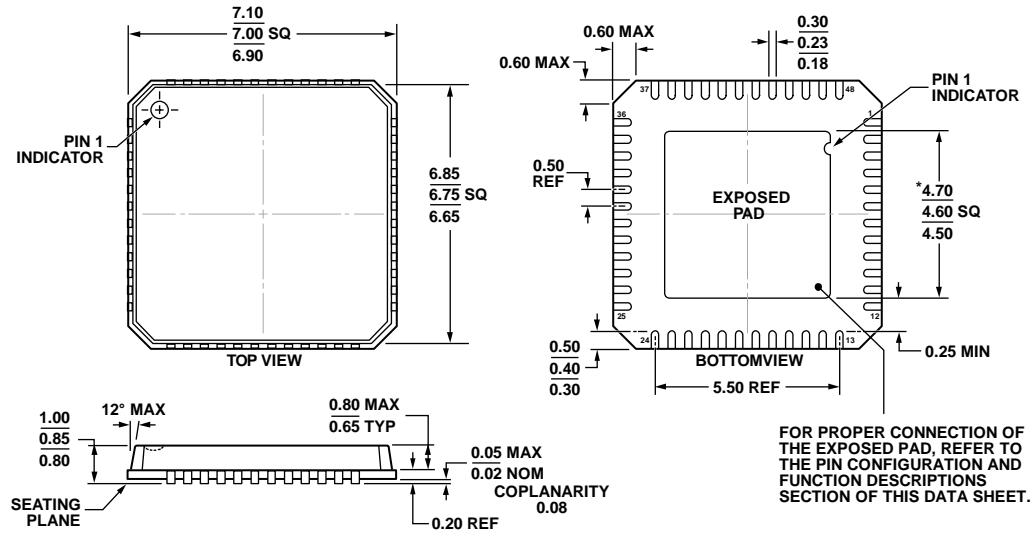

FOR PROPER CONNECTION OF THE EXPOSED PAD, REFER TO THE PIN CONFIGURATION AND FUNCTION DESCRIPTIONS SECTION OF THIS DATA SHEET.

*COMPLIANT TO JEDEC STANDARDS MO-220-VKGD-2 WITH EXCEPTION TO EXPOSED PAD DIMENSION

Figure 34. 48-Lead Lead Frame Chip Scale Package [LFCSP_VQ]
7 mm × 7 mm Body, Very Thin Quad
(CP-48-12)
Dimensions shown in millimeters

06-07-2012-A

ORDERING GUIDE

Model ¹	Temperature Range	Package Description	Package Option
AD9286BCPZ-500	-40°C to +85°C	48-Lead Lead Frame Chip Scale Package [LFCSP_VQ]	CP-48-12
AD9286BCPZRL7-500	-40°C to +85°C	48-Lead Lead Frame Chip Scale Package [LFCSP_VQ]	CP-48-12
AD9286-500EBZ		Evaluation Board	

¹ Z = RoHS Compliant Part.