



Is Now Part of



ON Semiconductor®

To learn more about ON Semiconductor, please visit our website at
www.onsemi.com

ON Semiconductor and the ON Semiconductor logo are trademarks of Semiconductor Components Industries, LLC dba ON Semiconductor or its subsidiaries in the United States and/or other countries. ON Semiconductor owns the rights to a number of patents, trademarks, copyrights, trade secrets, and other intellectual property. A listing of ON Semiconductor's product/patent coverage may be accessed at www.onsemi.com/site/pdf/Patent-Marking.pdf. ON Semiconductor reserves the right to make changes without further notice to any products herein. ON Semiconductor makes no warranty, representation or guarantee regarding the suitability of its products for any particular purpose, nor does ON Semiconductor assume any liability arising out of the application or use of any product or circuit, and specifically disclaims any and all liability, including without limitation special, consequential or incidental damages. Buyer is responsible for its products and applications using ON Semiconductor products, including compliance with all laws, regulations and safety requirements or standards, regardless of any support or applications information provided by ON Semiconductor. "Typical" parameters which may be provided in ON Semiconductor data sheets and/or specifications can and do vary in different applications and actual performance may vary over time. All operating parameters, including "Typicals" must be validated for each customer application by customer's technical experts. ON Semiconductor does not convey any license under its patent rights nor the rights of others. ON Semiconductor products are not designed, intended, or authorized for use as a critical component in life support systems or any FDA Class 3 medical devices or medical devices with a same or similar classification in a foreign jurisdiction or any devices intended for implantation in the human body. Should Buyer purchase or use ON Semiconductor products for any such unintended or unauthorized application, Buyer shall indemnify and hold ON Semiconductor and its officers, employees, subsidiaries, affiliates, and distributors harmless against all claims, costs, damages, and expenses, and reasonable attorney fees arising out of, directly or indirectly, any claim of personal injury or death associated with such unintended or unauthorized use, even if such claim alleges that ON Semiconductor was negligent regarding the design or manufacture of the part. ON Semiconductor is an Equal Opportunity/Affirmative Action Employer. This literature is subject to all applicable copyright laws and is not for resale in any manner.



FDFS6N754

Integrated N-Channel PowerTrench[®] MOSFET and Schottky Diode 30V, 4A, 56mΩ

Features

- Max $r_{DS(on)}$ = 56mΩ at $V_{GS} = 0V$, $I_D = 4A$
 Max $r_{DS(on)}$ = 75mΩ at $V_{GS} = 4.5V$, $I_D = 3.5A$
- $V_F < 0.45V @ 2A$
 $V_F < 0.28V @ 100mA$
- Schottky and MOSFET incorporated into single power surface mount SO-8 package
- Electrically independent Schottky and MOSFET pinout for design flexibility
- Low Gate Charge ($Q_g = 4nC$)
- Low Miller Charge



General Description

The FDFS6N754 combines the exceptional performance of Fairchild's PowerTrench MOSFET technology with a very low forward voltage drop Schottky barrier rectifier in an SO-8 package.

This device is designed specifically as a single package solution for DC to DC converters. It features a fast switching, low gate charge MOSFET with very low on-state resistance. The independently connected Schottky diode allows its use in a variety of DC/DC converter topologies.

Applications

- DC/DC converters

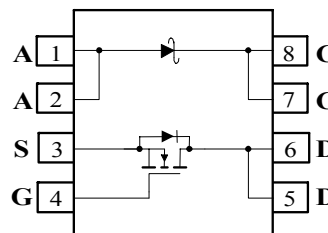
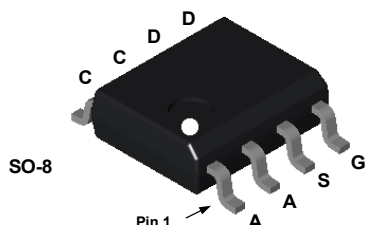

MOSFET Maximum Ratings $T_A = 25^\circ C$ unless otherwise noted

Symbol	Parameter	Ratings	Units
V_{DS}	Drain to Source Voltage	30	V
V_{GS}	Gate to Source Voltage	± 20	V
I_D	Drain Current -Continuous (Note 1a)	4	A
	-Pulsed	20	
P_D	Power Dissipation for Dual Operation	2	W
	Power Dissipation for Single Operation (Note 1a)	1.6	
V_{RRM}	Schottky Repetitive Peak Reverse Voltage	30	V
I_O	Schottky Average Forward Current (Note 1a)	2	A
T_J, T_{STG}	Operating and Storage Temperature	-55 to 150	$^\circ C$

Thermal Characteristics

$R_{\theta JA}$	Thermal Resistance, Junction-to-Ambient (Note 1a)	78	$^\circ C/W$
$R_{\theta JC}$	Thermal Resistance, Junction-to-Case (Note 1)	40	$^\circ C/W$

Package Marking and Ordering Information

Device Marking	Device	Package	Reel Size	Tape Width	Quantity
FDFS6N754	FDFS6N754	SO-8	330mm	12mm	2500 units

FDFS6N754 Integrated N-Channel PowerTrench[®] MOSFET and Schottky Diode

Electrical Characteristics $T_J = 25^\circ\text{C}$ unless otherwise noted

Symbol	Parameter	Test Conditions	Min	Typ	Max	Units
--------	-----------	-----------------	-----	-----	-----	-------

Off Characteristics

BV_{DSS}	Drain to Source Breakdown Voltage	$I_D = 250\mu\text{A}, V_{GS} = 0\text{V}$	30			V
$\frac{\Delta BV_{DSS}}{\Delta T_J}$	Breakdown Voltage Temperature Coefficient	$I_D = 250\mu\text{A}$, referenced to 25°C		24.5		$\text{mV}/^\circ\text{C}$
I_{DSS}	Zero Gate Voltage Drain Current	$V_{DS} = 24\text{V}$ $V_{GS} = 0\text{V}$ $T_J = 125^\circ\text{C}$			1 20	μA
I_{GSS}	Gate to Source Leakage Current	$V_{GS} = \pm 20\text{V}, V_{DS} = 0\text{V}$			± 100	nA

On Characteristics (Note 2)

$V_{GS(th)}$	Gate to Source Threshold Voltage	$V_{DS} = V_{GS}, I_D = 250\mu\text{A}$	1	1.7	2.5	V
$\frac{\Delta V_{GS(th)}}{\Delta T_J}$	Gate to Source Threshold Voltage Temperature Coefficient	$I_D = 250\mu\text{A}$, referenced to 25°C		-4.2		$\text{mV}/^\circ\text{C}$
$r_{DS(on)}$	Drain to Source On Resistance	$V_{GS} = 10\text{V}, I_D = 4\text{A}$		42	56	m Ω
		$V_{GS} = 4.5\text{V}, I_D = 3.5\text{A}$		53	75	
		$V_{GS} = 10\text{V}, I_D = 4\text{A}$, $T_J = 125^\circ\text{C}$		61	81	
g_{FS}	Forward Transconductance	$V_{DS} = 5\text{V}, I_D = 4\text{A}$		10		S

Dynamic Characteristics

C_{iss}	Input Capacitance	$V_{DS} = 15\text{V}, V_{GS} = 0\text{V}$, $f = 1.0\text{MHz}$		225	299	pF
C_{oss}	Output Capacitance			80	107	pF
C_{rss}	Reverse Transfer Capacitance			42	63	pF
R_G	Gate Resistance			5.1		Ω

Switching Characteristics (Note 2)

$t_{d(on)}$	Turn-On Delay Time	$V_{DD} = 15\text{V}, I_D = 1\text{A}$ $V_{GS} = 10\text{V}, R_{GS} = 6\Omega$		6	12	ns
t_r	Rise Time			8	16	ns
$t_{d(off)}$	Turn-Off Delay Time			20	32	ns
t_f	Fall Time			2	10	ns
$Q_{g(TOT)}$	Total Gate Charge at 10V	$V_{DS} = 15\text{V}$, $I_D = 4\text{A}$		4	6	nC
$Q_{g(5)}$	Total Gate Charge at 5V			2	3	nC
Q_{gs}	Gate to Source Gate Charge			0.6		nC
Q_{gd}	Gate to Drain "Miller" Charge			1		nC

Drain-Source Diode Characteristics and Maximum Ratings

V_{SD}	Source to Drain Diode Forward Voltage	$V_{GS} = 0\text{V}, I_S = 1.3\text{A}$ (Note 2)		0.8	1.2	V
t_{rr}	Reverse Recovery Time	$I_F = 4\text{A}, di/dt = 100\text{A}/\mu\text{s}$		13	20	ns
Q_{rr}	Reverse Recovery Charge	$I_F = 4\text{A}, di/dt = 100\text{A}/\mu\text{s}$		4	6	nC

Schottky Diode Characteristics

V_R	Reverse Breakdown Voltage	$I_R = -1\text{mA}$	-30			V
I_R	Reverse Leakage	$V_R = -10\text{V}$	$T_J = 25^\circ\text{C}$	39	250	μA
			$T_J = 125^\circ\text{C}$	18		mA
V_F	Forward Voltage	$I_F = 100\text{mA}$	$T_J = 25^\circ\text{C}$	225	280	mV
			$T_J = 125^\circ\text{C}$	140		
		$I_F = 2\text{A}$	$T_J = 25^\circ\text{C}$	364	450	
			$T_J = 125^\circ\text{C}$	290		

Notes:

1: $R_{\theta JA}$ is the sum of the junction-to-case and case-to-ambient thermal resistance where the case thermal reference is defined as the solder mounting surface of the drain pins. $R_{\theta JC}$ is guaranteed by design while $R_{\theta CA}$ is determined by the user's board design.

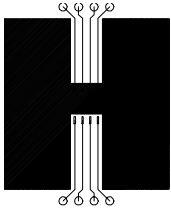

a) 78°C/W when mounted on a 0.5in² pad of 2 oz copper

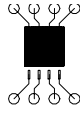

b) 125°C/W when mounted on a 0.02 in² pad of 2 oz copper

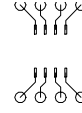

c) 135°C/W when mounted on a minimum pad

Scale 1 : 1 on letter size paper

2: Pulse Test: Pulse Width < 300µs, Duty Cycle < 2.0%.

Typical Characteristics $T_J = 25^\circ\text{C}$ unless otherwise noted

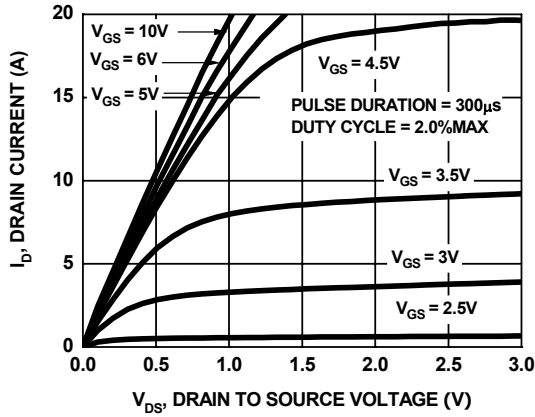

Figure 1. On Region Characteristics

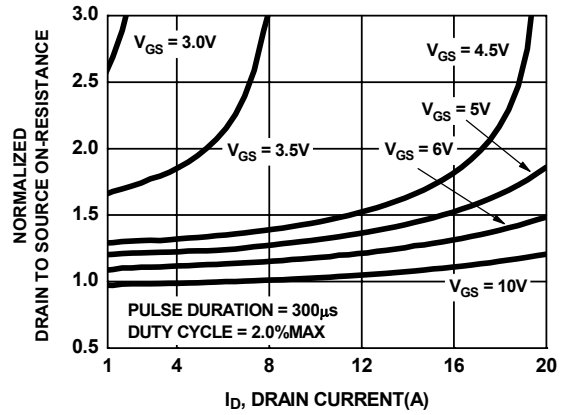

Figure 2. On-Resistance vs Drain Current and Gate Voltage

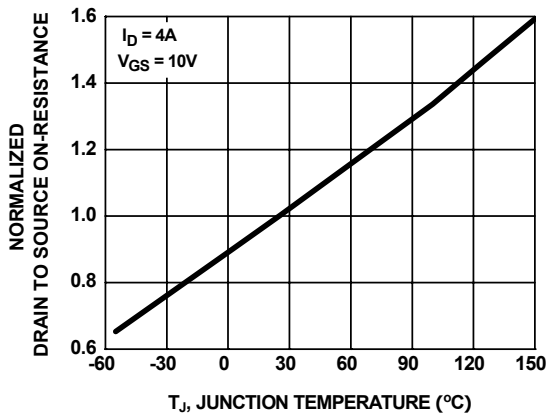

Figure 3. On Resistance vs Temperature

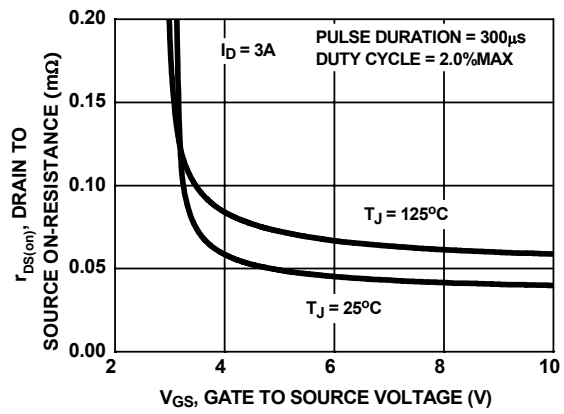

Figure 4. On-Resistance vs Gate to Source Voltage

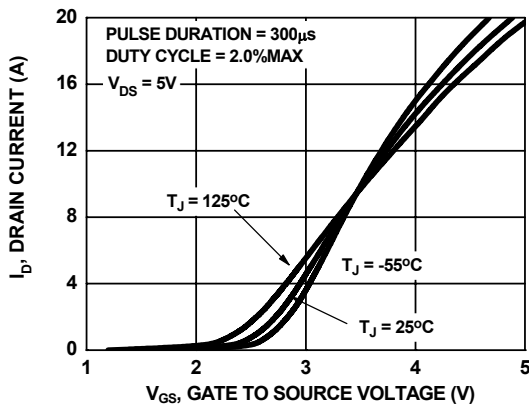

Figure 5. Transfer Characteristics

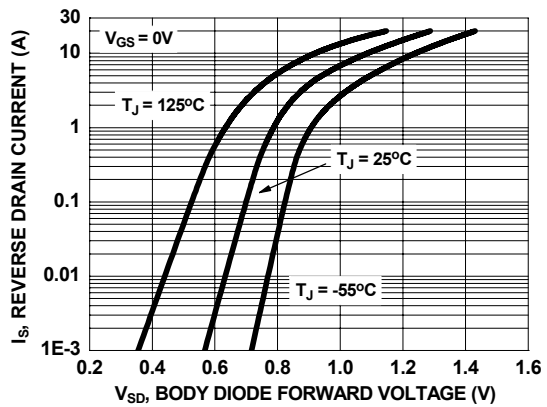

Figure 6. Source to Drain Diode Forward Voltage vs Source Current

Typical Characteristics $T_J = 25^\circ\text{C}$ unless otherwise noted

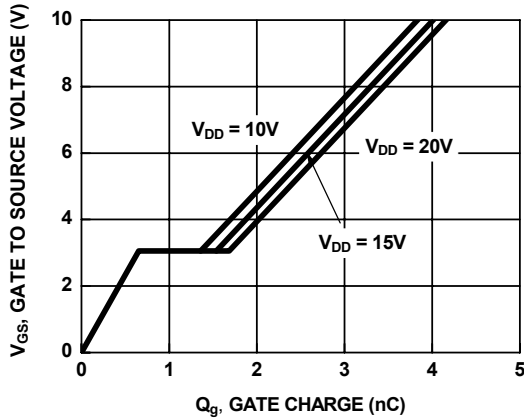

Figure 7. Gate Charge Characteristics

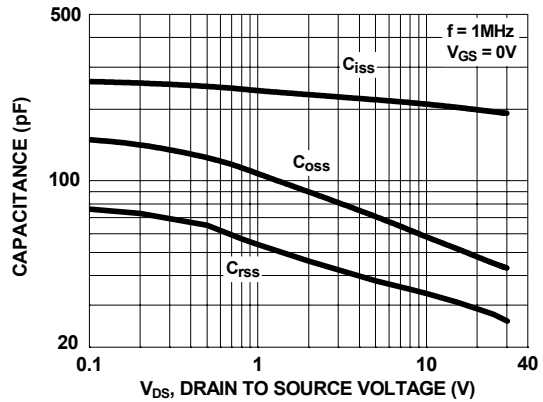

Figure 8. Capacitance vs Drain to Source Voltage

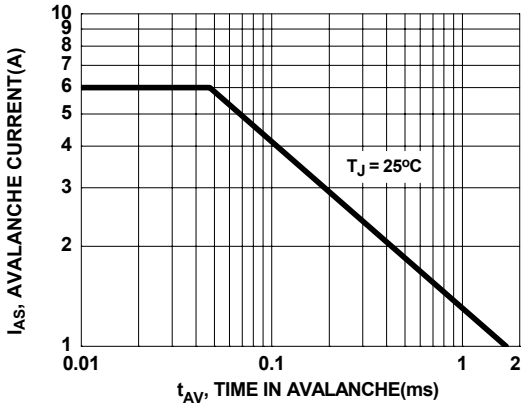

Figure 9. Unclamped Inductive Switching Capability

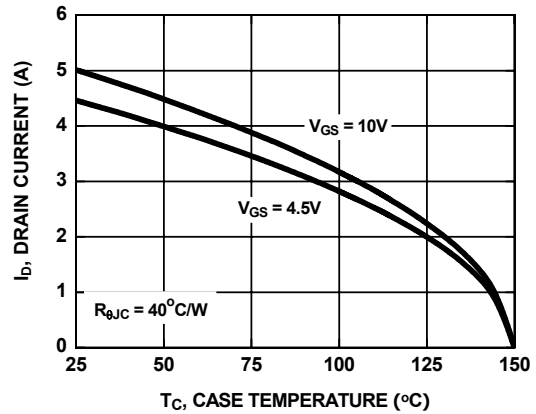

Figure 10. Maximum Continuous Drain Current vs Case Temperature

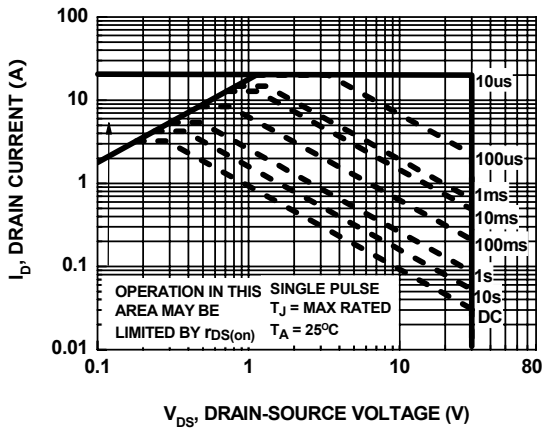

Figure 11. Forward Bias Safe Operating Area

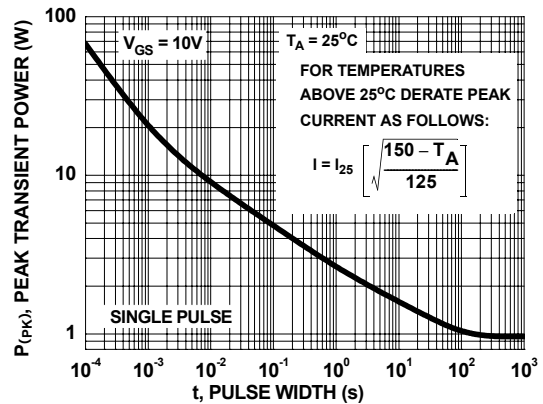

Figure 12. Single Pulse Maximum Power Dissipation

Typical Characteristics $T_J = 25^\circ\text{C}$ unless otherwise noted

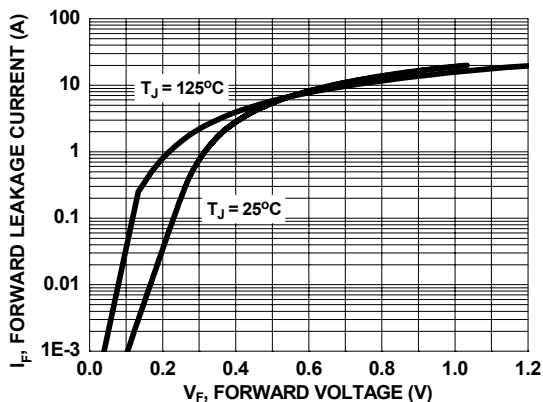

Figure 13. Schottky Diode Forward Voltage

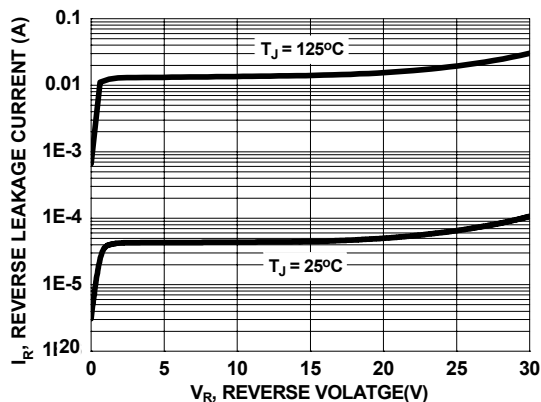

Figure 14. Schottky Diode Reverse Current

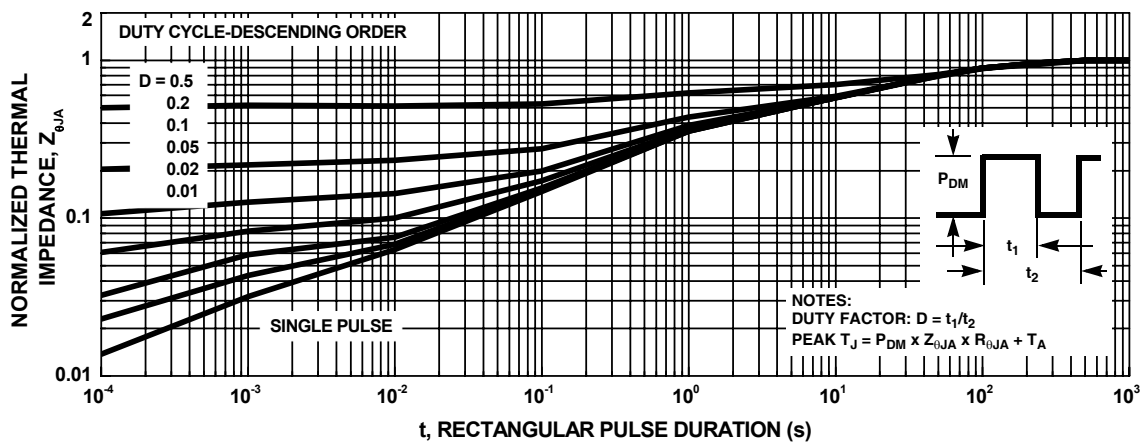
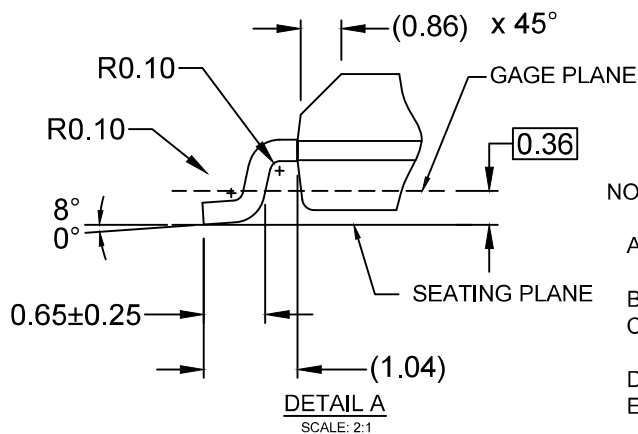
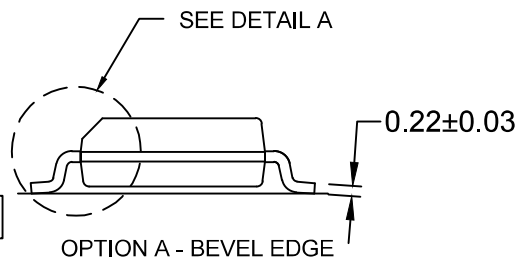
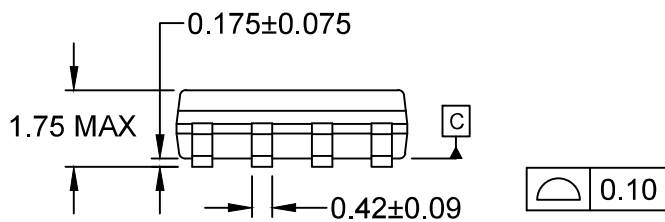
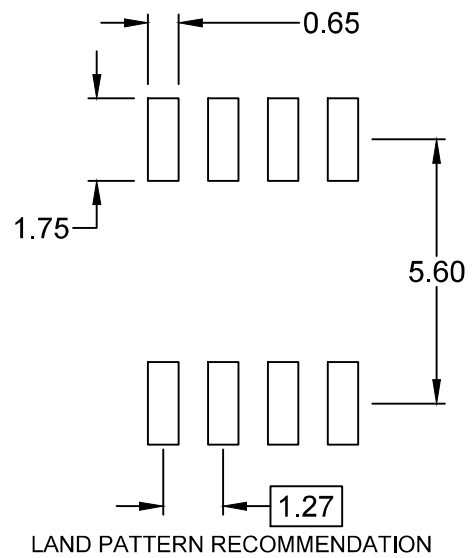
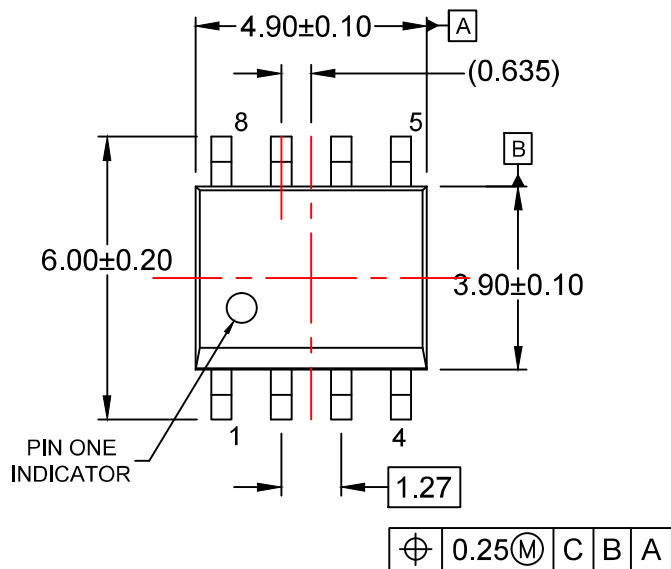

Figure 15. Transient Thermal Response Curve



NOTES:

- A) THIS PACKAGE CONFORMS TO JEDEC MS-012, VARIATION AA.
- B) ALL DIMENSIONS ARE IN MILLIMETERS.
- C) DIMENSIONS DO NOT INCLUDE MOLD FLASH OR BURRS.
- D) LANDPATTERN STANDARD: SOIC127P600X175-8M
- E) DRAWING FILENAME: M08Arev16



ON Semiconductor and  are trademarks of Semiconductor Components Industries, LLC dba ON Semiconductor or its subsidiaries in the United States and/or other countries. ON Semiconductor owns the rights to a number of patents, trademarks, copyrights, trade secrets, and other intellectual property. A listing of ON Semiconductor's product/patent coverage may be accessed at www.onsemi.com/site/pdf/Patent-Marking.pdf. ON Semiconductor reserves the right to make changes without further notice to any products herein. ON Semiconductor makes no warranty, representation or guarantee regarding the suitability of its products for any particular purpose, nor does ON Semiconductor assume any liability arising out of the application or use of any product or circuit, and specifically disclaims any and all liability, including without limitation special, consequential or incidental damages. Buyer is responsible for its products and applications using ON Semiconductor products, including compliance with all laws, regulations and safety requirements or standards, regardless of any support or applications information provided by ON Semiconductor. "Typical" parameters which may be provided in ON Semiconductor data sheets and/or specifications can and do vary in different applications and actual performance may vary over time. All operating parameters, including "Typicals" must be validated for each customer application by customer's technical experts. ON Semiconductor does not convey any license under its patent rights nor the rights of others. ON Semiconductor products are not designed, intended, or authorized for use as a critical component in life support systems or any FDA Class 3 medical devices or medical devices with a same or similar classification in a foreign jurisdiction or any devices intended for implantation in the human body. Should Buyer purchase or use ON Semiconductor products for any such unintended or unauthorized application, Buyer shall indemnify and hold ON Semiconductor and its officers, employees, subsidiaries, affiliates, and distributors harmless against all claims, costs, damages, and expenses, and reasonable attorney fees arising out of, directly or indirectly, any claim of personal injury or death associated with such unintended or unauthorized use, even if such claim alleges that ON Semiconductor was negligent regarding the design or manufacture of the part. ON Semiconductor is an Equal Opportunity/Affirmative Action Employer. This literature is subject to all applicable copyright laws and is not for resale in any manner.

PUBLICATION ORDERING INFORMATION

LITERATURE FULFILLMENT:

Literature Distribution Center for ON Semiconductor
19521 E. 32nd Pkwy, Aurora, Colorado 80011 USA
Phone: 303-675-2175 or 800-344-3860 Toll Free USA/Canada
Fax: 303-675-2176 or 800-344-3867 Toll Free USA/Canada
Email: orderlit@onsemi.com

N. American Technical Support: 800-282-9855 Toll Free
USA/Canada
Europe, Middle East and Africa Technical Support:
Phone: 421 33 790 2910
Japan Customer Focus Center
Phone: 81-3-5817-1050

ON Semiconductor Website: www.onsemi.com
Order Literature: <http://www.onsemi.com/orderlit>
For additional information, please contact your local
Sales Representative