



Is Now Part of



ON Semiconductor®

To learn more about ON Semiconductor, please visit our website at
www.onsemi.com

ON Semiconductor and the ON Semiconductor logo are trademarks of Semiconductor Components Industries, LLC dba ON Semiconductor or its subsidiaries in the United States and/or other countries. ON Semiconductor owns the rights to a number of patents, trademarks, copyrights, trade secrets, and other intellectual property. A listing of ON Semiconductor's product/patent coverage may be accessed at www.onsemi.com/site/pdf/Patent-Marking.pdf. ON Semiconductor reserves the right to make changes without further notice to any products herein. ON Semiconductor makes no warranty, representation or guarantee regarding the suitability of its products for any particular purpose, nor does ON Semiconductor assume any liability arising out of the application or use of any product or circuit, and specifically disclaims any and all liability, including without limitation special, consequential or incidental damages. Buyer is responsible for its products and applications using ON Semiconductor products, including compliance with all laws, regulations and safety requirements or standards, regardless of any support or applications information provided by ON Semiconductor. "Typical" parameters which may be provided in ON Semiconductor data sheets and/or specifications can and do vary in different applications and actual performance may vary over time. All operating parameters, including "Typicals" must be validated for each customer application by customer's technical experts. ON Semiconductor does not convey any license under its patent rights nor the rights of others. ON Semiconductor products are not designed, intended, or authorized for use as a critical component in life support systems or any FDA Class 3 medical devices or medical devices with a same or similar classification in a foreign jurisdiction or any devices intended for implantation in the human body. Should Buyer purchase or use ON Semiconductor products for any such unintended or unauthorized application, Buyer shall indemnify and hold ON Semiconductor and its officers, employees, subsidiaries, affiliates, and distributors harmless against all claims, costs, damages, and expenses, and reasonable attorney fees arising out of, directly or indirectly, any claim of personal injury or death associated with such unintended or unauthorized use, even if such claim alleges that ON Semiconductor was negligent regarding the design or manufacture of the part. ON Semiconductor is an Equal Opportunity/Affirmative Action Employer. This literature is subject to all applicable copyright laws and is not for resale in any manner.



FIN1002 LVDS 1-Bit, High-Speed Differential Receiver

Features

- Greater than 400 Mbs Data Rate
- 3.3 V Power Supply Operation
- 0.4 ns Maximum Pulse Skew
- 2.5 ns Maximum Propagation Delay
- Bus Pin ESD (HBM) Protection Exceeds 10 kV
- Power-Off, Over-voltage tolerant Input and Output
- Fail-safe Protection for open-circuit and non-driven, shorted, or terminated Conditions
- High-impedance Output at $V_{CC} < 1.5$ V
- Meets or exceeds TIA/EIA-644 LVDS Standard
- 5-Lead SOT23 Package saves Space

Description

This single receiver is designed for high-speed interconnects utilizing Low Voltage Differential Signaling (LVDS) technology. The receiver translates LVDS levels, with a typical differential input threshold of 100 mV, to LVTTTL signal levels. LVDS provides low EMI at ultra low power dissipation even at high frequencies. This device is ideal for high-speed transfer of clock or data. The FIN1002 can be paired with its companion driver, the FIN1001, or with any other LVDS driver.

Ordering Information

Part Number	Operating Temperature Range	Package	Packing Method	Packing Quantity
FIN1002M5	-40 to +125°C	5-Lead SOT23, JEDEC MO-178, 1.6 mm	Tube	250
FIN1002M5X	-40 to +125°C	5-Lead SOT23, JEDEC MO-178, 1.6 mm	Tape & Reel	3000

Connection Diagram

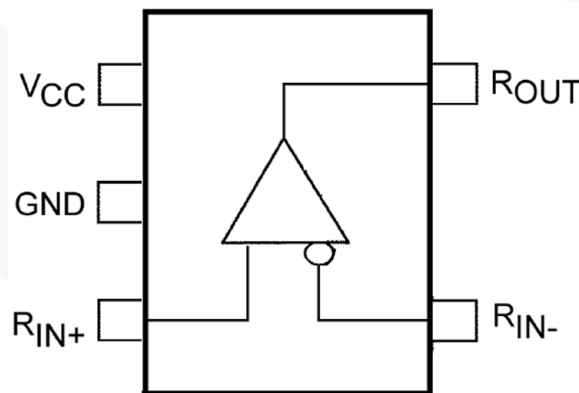

Figure 1. Top View

Pin Configuration

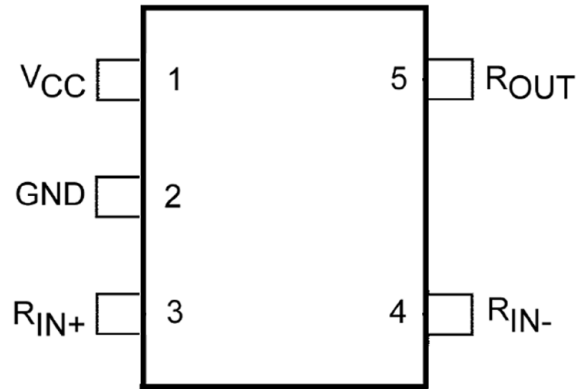

Figure 2. Pin Configuration

Pin Definitions

Pin #	Name	Description
1	V _{CC}	Power Supply
2	GND	Ground for the IC
3	R _{IN+}	Non-inverting Driver Input
4	R _{IN-}	Inverting Driver Input
5	R _{OUT}	LVTTTL Data Output

Function Table

Inputs		Outputs
R _{IN+}	R _{IN-}	R _{OUT}
LOW	HIGH	LOW
HIGH	LOW	HIGH
Fail-Safe Condition (Open, Shorted, Terminated)		HIGH

Absolute Maximum Ratings

Stresses exceeding the absolute maximum ratings may damage the device. The device may not function or be operable above the recommended operating conditions and stressing the parts to these levels is not recommended. In addition, extended exposure to stresses above the recommended operating conditions may affect device reliability. The absolute maximum ratings are stress ratings only.

Symbol	Parameter		Min.	Max.	Unit
V_{CC}	Supply Voltage		-0.5	4.6	V
R_{IN+} / R_{IN-}	Input Voltage		-0.5	4.6	V
D_{OUT}	DC Output Voltage		-0.5	6.0	V
I_O	Output Current			16	mA
T_{STG}	Storage Temperature Range		-65	+150	°C
T_J	Maximum Junction Temperature			+150	°C
T_L	Lead Temperature, Soldering, 10 Seconds			+260	°C
ESD	Electrostatic Discharge	Human Body Model		8	kV
		LVDS Pins to GND		10	
		Machine Model		400	V

Recommended Operating Conditions

The Recommended Operating Conditions table defines the conditions for actual device operation. Recommended operating conditions are specified to ensure optimal performance to the datasheet specifications. Fairchild does not recommend exceeding them or designing to Absolute Maximum Ratings.

Symbol	Parameter	Min.	Max.	Unit
V_{CC}	Supply Voltage	3.0	3.6	V
V_{IN}	Input Voltage	0	V_{CC}	V
V_{ID}	Magnitude of Differential Voltage	100	V_{CC}	mV
V_{IC}	Common-mode Input Voltage	$0 + V_{ID} / 2$	$2.4 - V_{ID} / 2$	V
T_A	Operating Temperature	-40	+125	°C

DC Electrical Characteristics⁽¹⁾

All min. and max. values are guaranteed at $T_A = -40$ to $+125^\circ\text{C}$. All typical values are at $T_A = 25^\circ\text{C}$ and with $V_{CC} = 3.3$ V, unless otherwise specified.

Symbol	Parameter	Conditions	Min.	Typ.	Max.	Units
V_{TH}	Differential Input Threshold HIGH	$V_{IC} = +0.05$ V, 1.2 V, or 2.35 V Figure 3			100	mV
V_{TL}	Differential Input Threshold LOW	$V_{IC} = +0.05$ V, 1.2 V, or 2.35 V Figure 3	-100			mV
I_{IN}	Input Current	$V_{IN} = 0$ V or V_{CC}			± 20	μA
$I_{I(OFF)}$	Power-OFF Input Current	$V_{CC} = 0$ V, $V_{IN} = 0$ V or 3.6 V			± 20	μA
V_{OH}	Output HIGH Voltage	$I_{OH} = -100$ μA	$V_{CC} - 0.2$	3.3		V
		$I_{OH} = -8$ mA	2.4	3.1		
V_{OL}	Output LOW Voltage	$I_{OH} = 100$ μA		0	0.2	V
		$I_{OL} = 8$ mA		0.16	0.50	
V_{IK}	Input Clamp Voltage	$I_{IK} = -18$ mA	-1.5	0.8		V
I_{CC}	Power Supply Current	($R_{IN+} = 1$ V and $R_{IN-} = 1.4$ V) or ($R_{IN+} = 1.4$ V and $R_{IN-} = 1$ V)		4	7	mA
C_{IN}	Input Capacitance	$V_{CC} = 3.3$ V		2.3		pF
C_{OUT}	Output Capacitance	$V_{CC} = 0$ V		2.8		pF

Note:

- Not production tested across the full temperature range.

AC Electrical Characteristics

All min. and max. values are guaranteed at $T_A = -40$ to $+85^\circ\text{C}$. All typical values are at $T_A = 25^\circ\text{C}$ and with $V_{CC} = 3.3$ V, unless otherwise specified.

$|V_{ID}| = 400$ mV, $C_L = 10$ pF. See Figure 3 and Figure 4.

Symbol	Parameter	Conditions	Min.	Typ.	Max.	Units
t_{PLH}	Propagation Delay	LOW to HIGH	0.9	1.5	2.5	ns
t_{PHL}	Propagation Delay	HIGH to LOW	0.9	1.5	2.5	ns
t_{TLH}	Output Rise Time	20% to 80%		0.6		ns
t_{THL}	Output Fall Time	80% to 20%		0.5		ns
$t_{SK(p)}$	Pulse Skew	$ t_{PLH} - t_{PHL} $		0.02	0.4	ns
$t_{SK(PP)}$	Part-to-Part Skew ⁽²⁾				1.0	ns

Note:

- $t_{SK(PP)}$ is the magnitude of the difference in propagation delay times between any specified terminals of two devices switching in the same direction (either LOW-to-HIGH or HIGH-to-LOW) when both devices operate with the same supply voltage, same temperature, and have identical test circuits.

Test Diagrams

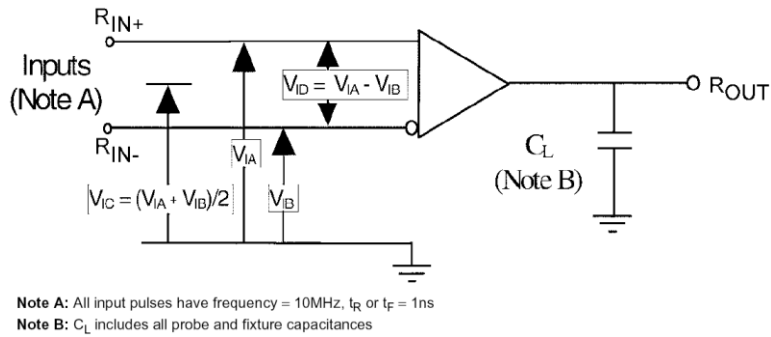

Figure 3. Differential Receiver Voltage Definitions and Propagation Delay and Transition Time Test Circuit

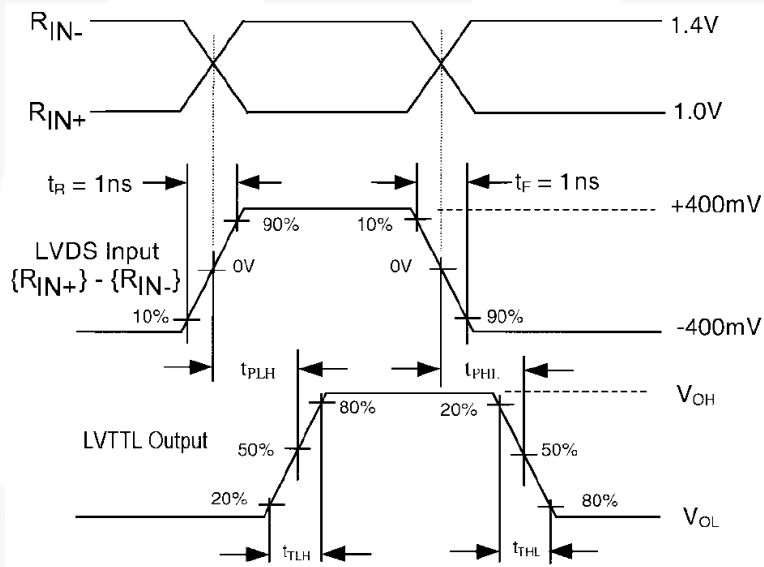

Figure 4. LVDS Input to LVTTTL Output AC Waveforms

Typical Performance Characteristics

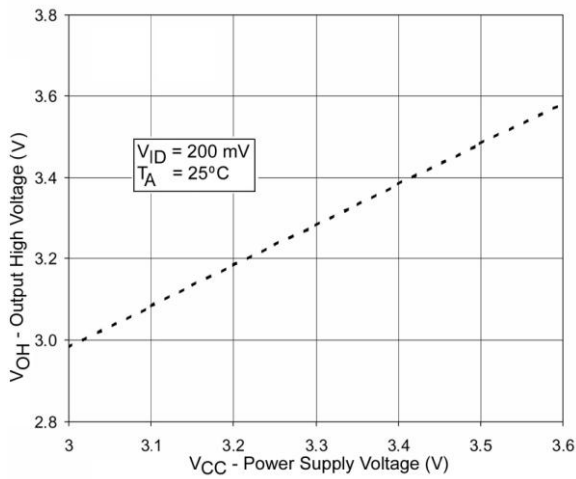

Figure 5. Output High Voltage vs. Power Supply Voltage

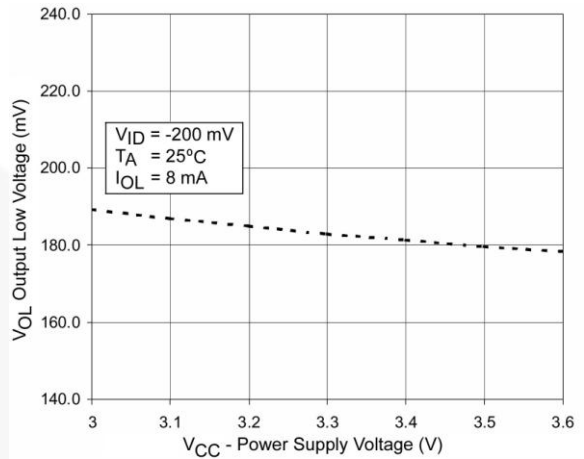

Figure 6. Output Low Voltage vs. Power Supply Voltage

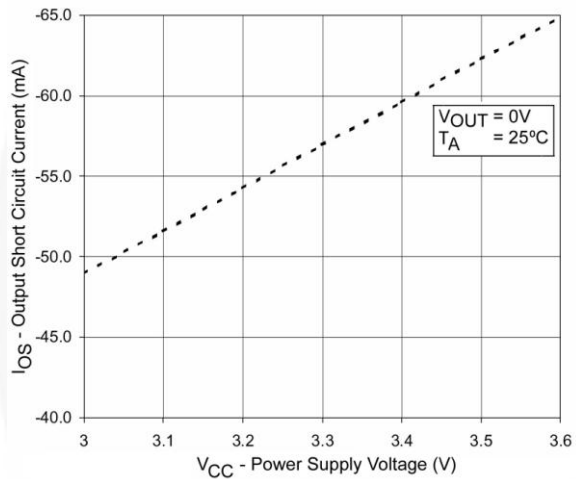

Figure 7. Output Short Circuit Current vs. Power Supply Voltage

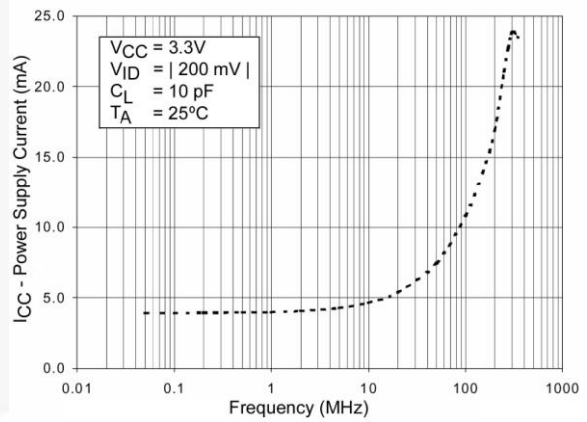

Figure 8. Power Supply Current vs. Frequency

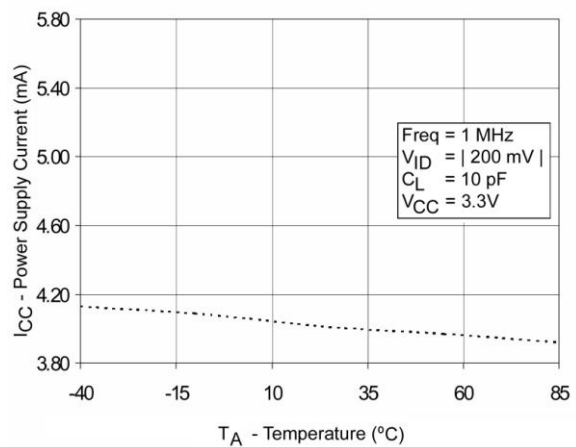

Figure 9. Power Supply Current vs. Ambient Temperature

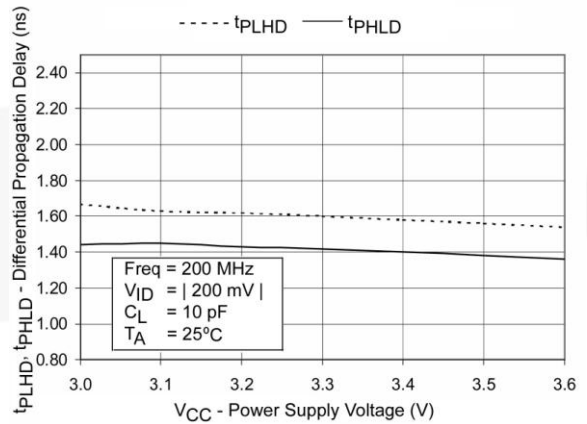

Figure 10. Differential Propagation Delay Power Supply Voltage

Typical Performance Characteristics (Continued)

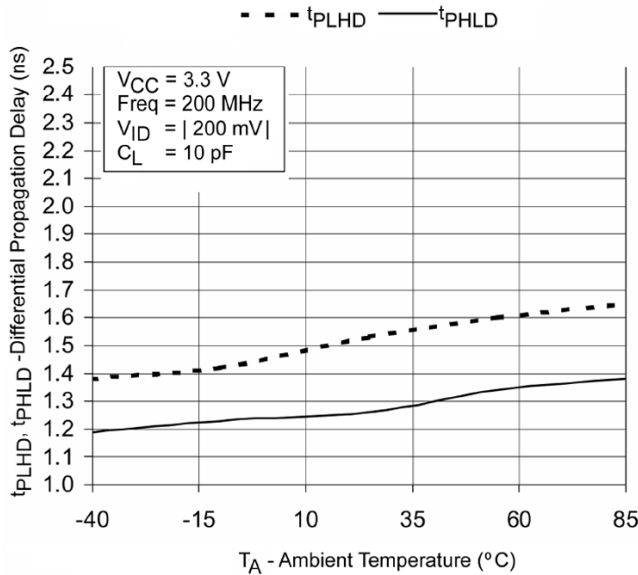

Figure 11. Differential Propagation Delay vs. Ambient Temperature

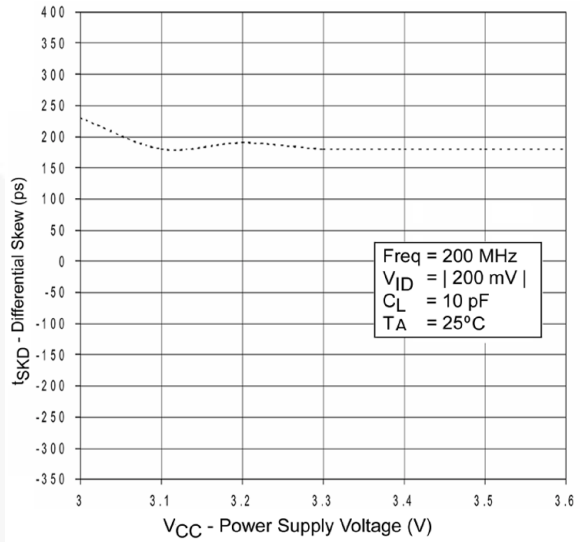

Figure 12. Differential Skew vs. Power Supply Voltage

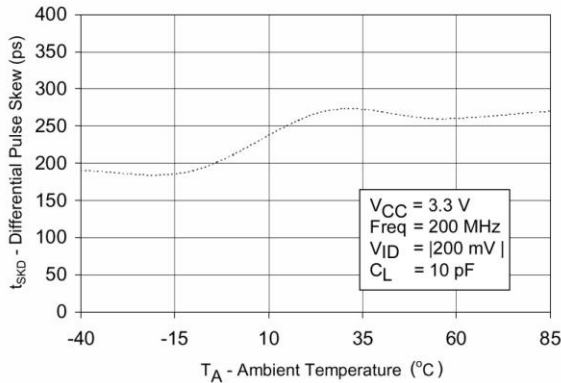

Figure 13. Differential Skew vs. Ambient Temperature

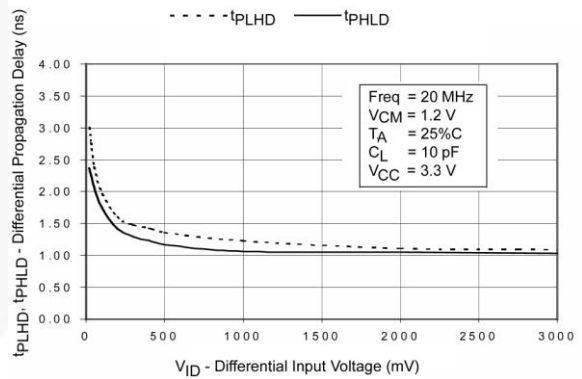

Figure 14. Differential Propagation Delay vs. Differential Input Voltage

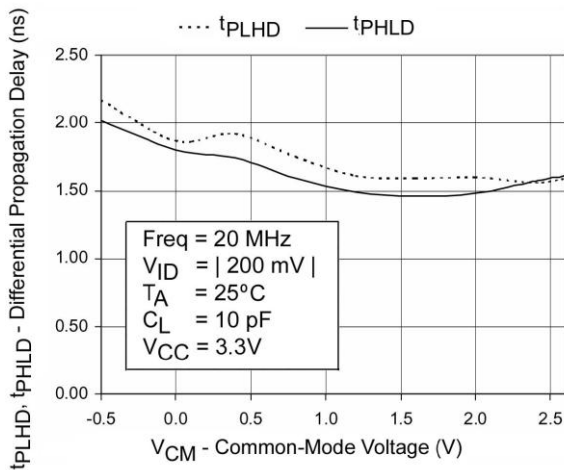

Figure 15. Differential Propagation Delay vs. Common-Mode Voltage

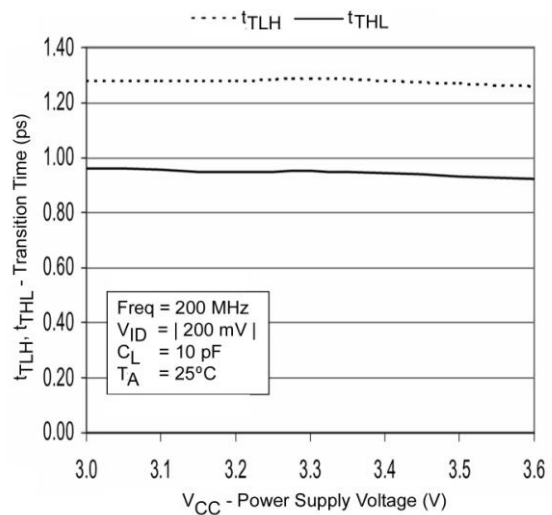

Figure 16. Transition Time vs. Power Supply Voltage

Typical Performance Characteristics (Continued)

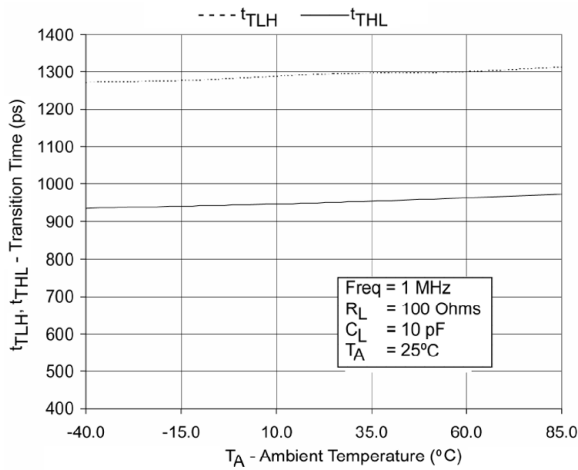

Figure 17. Transition Time vs. Ambient Temperature

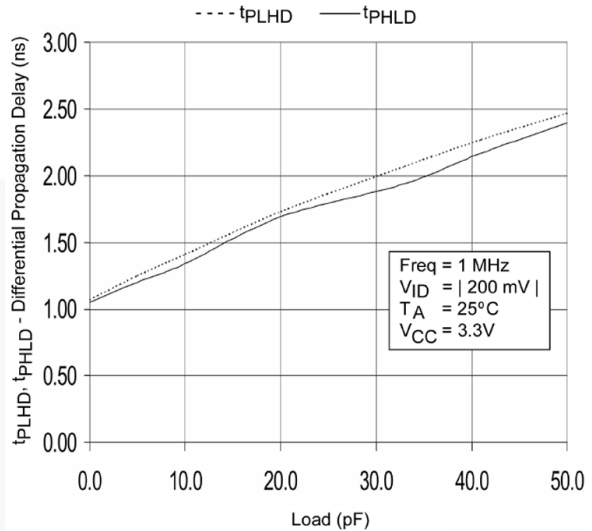

Figure 18. Differential Propagation Delay vs. Load

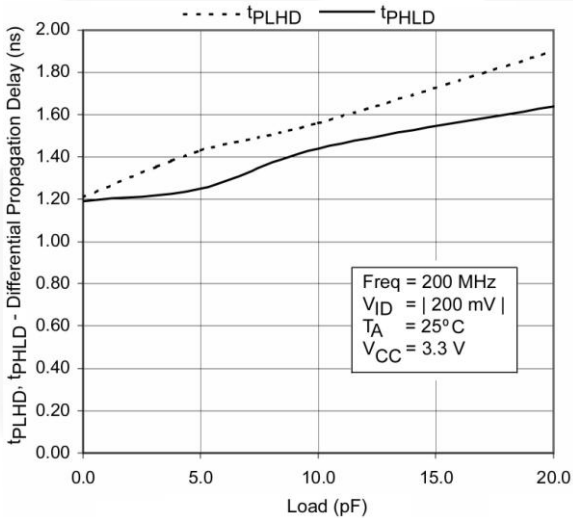

Figure 19. Differential Propagation Delay vs. Load

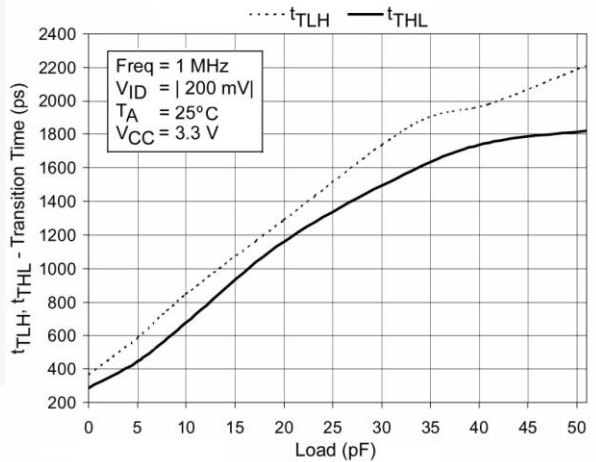

Figure 20. Transition Time vs. Load

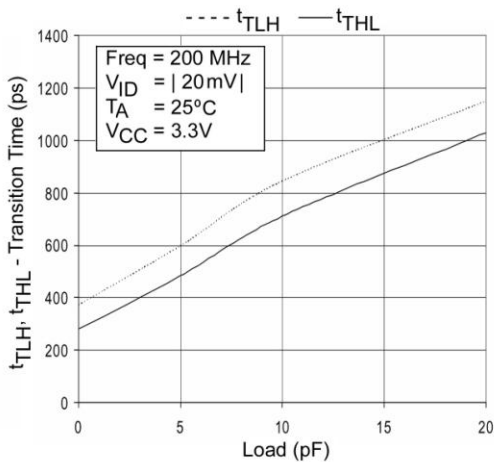

Figure 21. Transition Time vs. Load

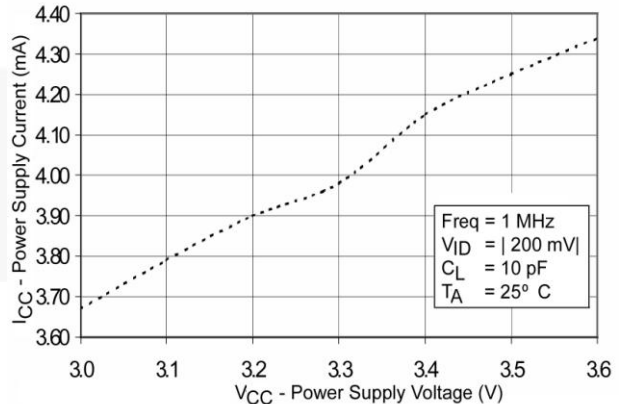
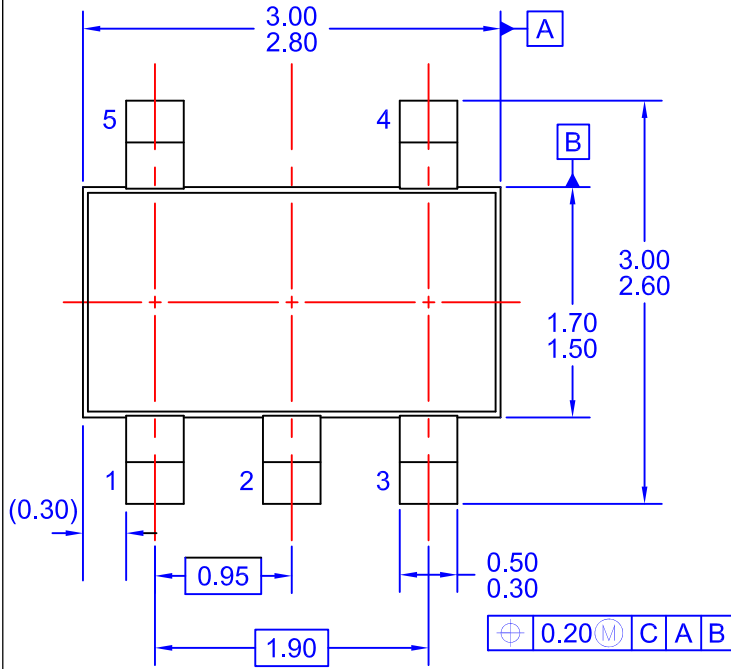
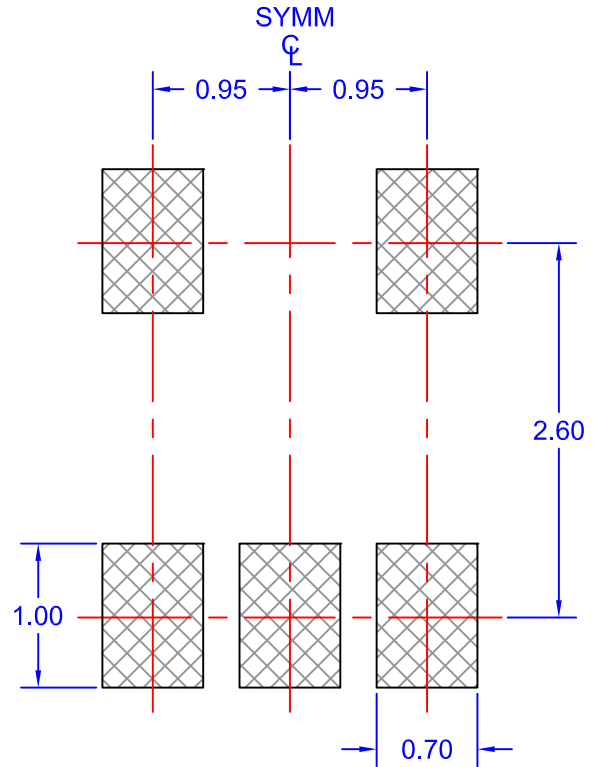

Figure 22. Power Supply Current vs. Power Supply Voltage



TOP VIEW



LAND PATTERN RECOMMENDATION

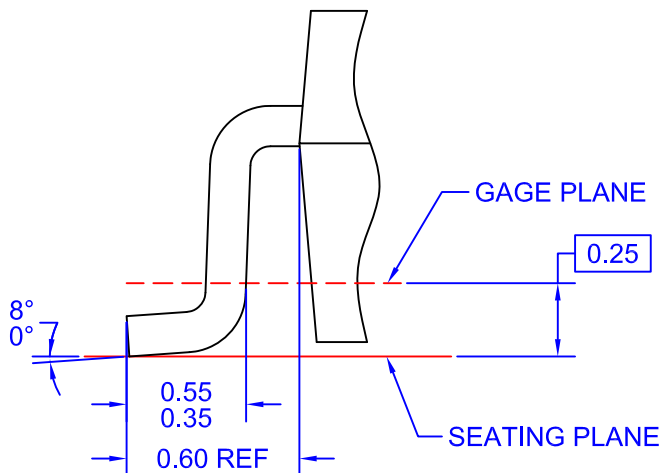
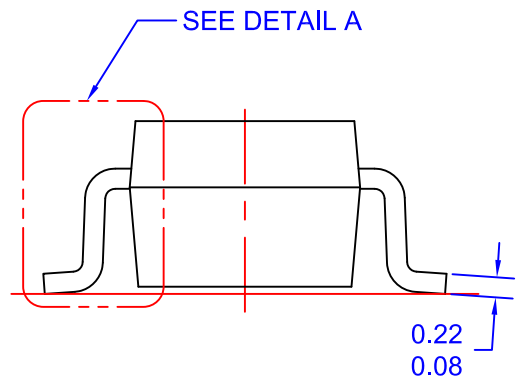
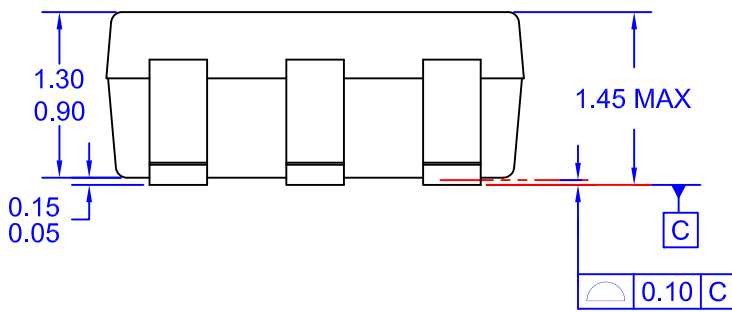

- NOTES: UNLESS OTHERWISE SPECIFIED
- A) PACKAGE STANDARD REFERENCE: JEDEC REGISTRATION, MO-178, ISSUE B, VARIATION AA.
 - B) ALL DIMENSIONS ARE IN MILLIMETERS.
 - C) DIMENSIONS DO NOT INCLUDE BURRS OR MOLD FLASH. MOLD FLASH OR BURRS DOES NOT EXCEED 0.10MM.
 - D) DIMENSIONING AND TOLERANCING PER ASME Y14.5M-2009.
 - E) DRAWING FILE NAME: MKT-MA05BREV6



ON Semiconductor and  are trademarks of Semiconductor Components Industries, LLC dba ON Semiconductor or its subsidiaries in the United States and/or other countries. ON Semiconductor owns the rights to a number of patents, trademarks, copyrights, trade secrets, and other intellectual property. A listing of ON Semiconductor's product/patent coverage may be accessed at www.onsemi.com/site/pdf/Patent-Marking.pdf. ON Semiconductor reserves the right to make changes without further notice to any products herein. ON Semiconductor makes no warranty, representation or guarantee regarding the suitability of its products for any particular purpose, nor does ON Semiconductor assume any liability arising out of the application or use of any product or circuit, and specifically disclaims any and all liability, including without limitation special, consequential or incidental damages. Buyer is responsible for its products and applications using ON Semiconductor products, including compliance with all laws, regulations and safety requirements or standards, regardless of any support or applications information provided by ON Semiconductor. "Typical" parameters which may be provided in ON Semiconductor data sheets and/or specifications can and do vary in different applications and actual performance may vary over time. All operating parameters, including "Typicals" must be validated for each customer application by customer's technical experts. ON Semiconductor does not convey any license under its patent rights nor the rights of others. ON Semiconductor products are not designed, intended, or authorized for use as a critical component in life support systems or any FDA Class 3 medical devices or medical devices with a same or similar classification in a foreign jurisdiction or any devices intended for implantation in the human body. Should Buyer purchase or use ON Semiconductor products for any such unintended or unauthorized application, Buyer shall indemnify and hold ON Semiconductor and its officers, employees, subsidiaries, affiliates, and distributors harmless against all claims, costs, damages, and expenses, and reasonable attorney fees arising out of, directly or indirectly, any claim of personal injury or death associated with such unintended or unauthorized use, even if such claim alleges that ON Semiconductor was negligent regarding the design or manufacture of the part. ON Semiconductor is an Equal Opportunity/Affirmative Action Employer. This literature is subject to all applicable copyright laws and is not for resale in any manner.

PUBLICATION ORDERING INFORMATION

LITERATURE FULFILLMENT:

Literature Distribution Center for ON Semiconductor
19521 E. 32nd Pkwy, Aurora, Colorado 80011 USA
Phone: 303-675-2175 or 800-344-3860 Toll Free USA/Canada
Fax: 303-675-2176 or 800-344-3867 Toll Free USA/Canada
Email: orderlit@onsemi.com

N. American Technical Support: 800-282-9855 Toll Free
USA/Canada
Europe, Middle East and Africa Technical Support:
Phone: 421 33 790 2910
Japan Customer Focus Center
Phone: 81-3-5817-1050

ON Semiconductor Website: www.onsemi.com
Order Literature: <http://www.onsemi.com/orderlit>
For additional information, please contact your local
Sales Representative