

Analog Devices Welcomes Hittite Microwave Corporation

NO CONTENT ON THE ATTACHED DOCUMENT HAS CHANGED



HMC608* Product Page Quick Links

Last Content Update: 11/01/2016

[Comparable Parts](#)

View a parametric search of comparable parts

[Evaluation Kits](#)

- HMC608LC4 Evaluation Board

[Documentation](#)

Application Notes

- AN-1363: Meeting Biasing Requirements of Externally Biased RF/Microwave Amplifiers with Active Bias Controllers
- Broadband Biasing of Amplifiers General Application Note
- MMIC Amplifier Biasing Procedure Application Note
- Thermal Management for Surface Mount Components General Application Note

Data Sheet

- HMC608 Data Sheet

[Tools and Simulations](#)

- HMC608 S-Parameter

[Reference Materials](#)

Quality Documentation

- Package/Assembly Qualification Test Report: LC4, LC4B (QTR: 2014-00380 REV: 01)
- Semiconductor Qualification Test Report: PHEMT-F (QTR: 2013-00269)

[Design Resources](#)

- HMC608 Material Declaration
- PCN-PDN Information
- Quality And Reliability
- Symbols and Footprints

[Discussions](#)

View all HMC608 EngineerZone Discussions

[Sample and Buy](#)

Visit the product page to see pricing options

[Technical Support](#)

Submit a technical question or find your regional support number

THIS PAGE INTENTIONALLY LEFT BLANK

GaAs pHEMT MEDIUM POWER AMPLIFIER, 9.5 - 11.5 GHz

Typical Applications

The HMC608LC4 is ideal for:

- Point-to-Point Radios
- Point-to-Multi-Point Radios
- Military End-Use

Features

- Output IP3: +33 dBm
- Saturated Power: +27.5 dBm @ 23% PAE
- Gain: 29.5 dB
- Supply: +5V @ 310 mA
- 50 Ohm Matched Input/Output
- RoHS Compliant 4x4 mm SMT Package

Functional Diagram

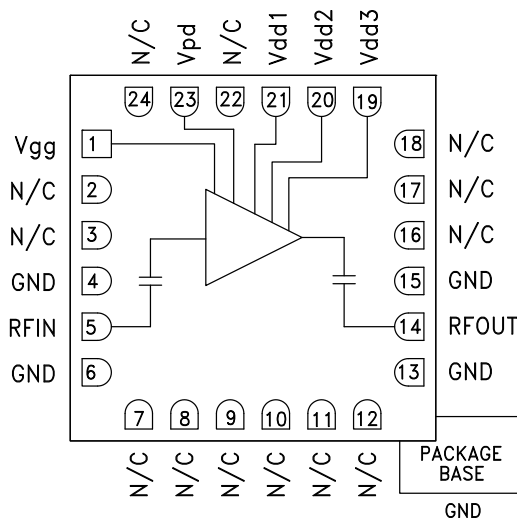

General Description

The HMC608LC4 is a high dynamic range GaAs pHEMT MMIC Medium Power Amplifier housed in a leadless "Pb free" SMT package. The amplifier has two modes of operation: high gain mode (Vpd pin shorted to ground); and low gain mode (Vpd pin left open). The electrical specifications in the table below are shown for the amplifier operating in high gain mode. Operating from 9.5 to 11.5 GHz, the amplifier provides 29.5 dB of gain, +27.5 dBm of saturated power and 23% PAE from a +5V supply voltage. Noise figure is 6 dB while output IP3 is +33 dBm. The RF I/Os are DC blocked and matched to 50 Ohms for ease of use. The HMC608LC4 eliminates the need for wire bonding, allowing use of surface mount manufacturing techniques.

Electrical Specifications, $T_A = +25^\circ \text{C}$, $V_{dd1, 2, 3} = 5\text{V}$, $I_{dd} = 310 \text{ mA}$ [1], $V_{pd} = \text{GND}$ [2]

| Parameter | Min. | Typ. | Max. | Units |
|--|------------|------|------|--------|
| Frequency Range | 9.5 - 11.5 | | | GHz |
| Gain [3] | 27 | 29.5 | | dB |
| Gain Variation Over Temperature | | 0.02 | 0.03 | dB/ °C |
| Input Return Loss | | 13 | | dB |
| Output Return Loss | | 19 | | dB |
| Output Power for 1 dB Compression (P1dB) | 23 | 27 | | dBm |
| Saturated Output Power (P _{sat}) | | 27.5 | | dBm |
| Output Third Order Intercept (IP3) | | 33 | | dBm |
| Noise Figure | | 6.0 | | dB |
| Supply Current ($I_{dd} = I_{dd1} + I_{dd2} + I_{dd3}$)($V_{dd} = +5\text{V}$, $V_{gg} = -2.6\text{V}$ Typ.) [3] | | 310 | 350 | mA |

[[1] Adjust Vgg between -3 to 0V to achieve I_{dd} = 310 mA typical.

[2] Vpd= ground for high gain mode, Vpd = open for low gain mode.

[3] In low gain mode, typical gain is 22 dB and typical current is 67 mA.



**GaAs pHEMT MEDIUM
POWER AMPLIFIER, 9.5 - 11.5 GHz**

Broadband Gain & Return Loss

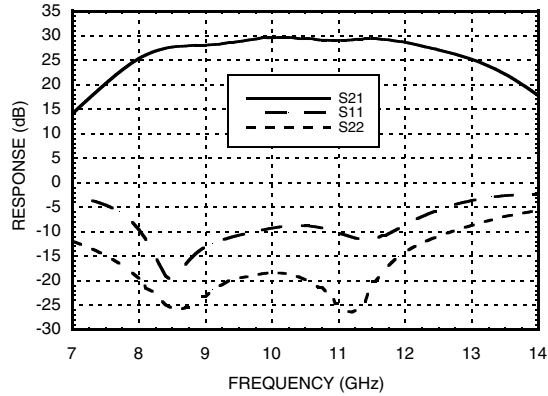

Gain vs. Temperature

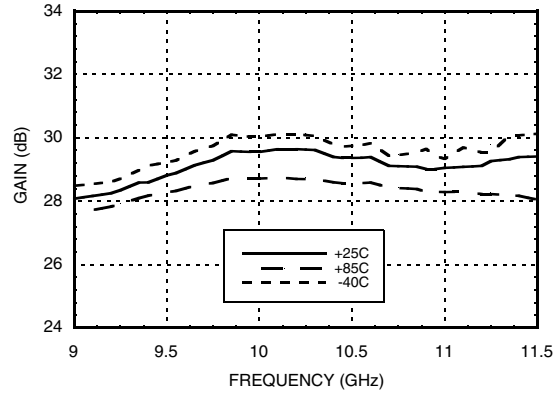

Input Return Loss vs. Temperature

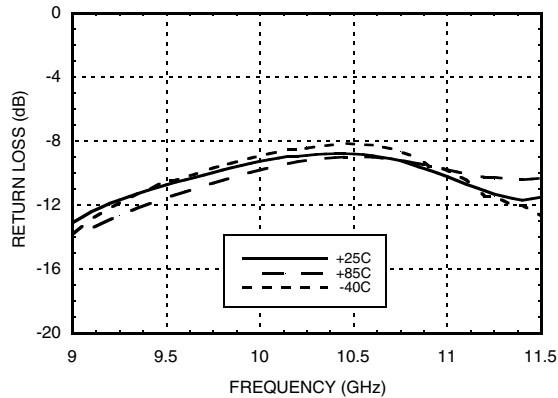

Output Return Loss vs. Temperature

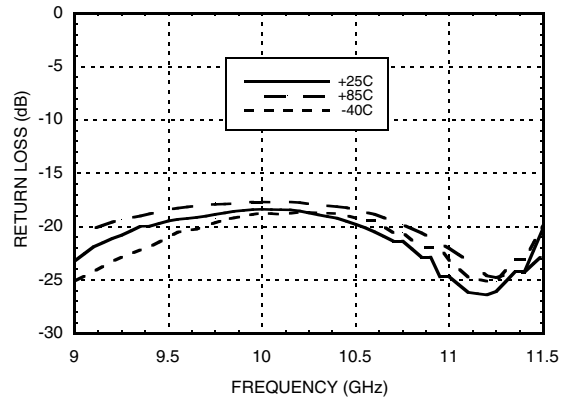

P1dB vs. Temperature

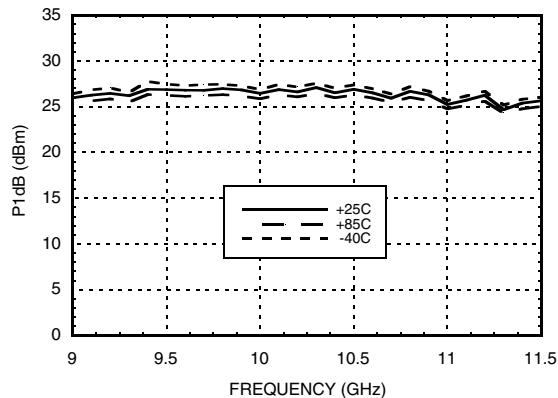

Psat vs. Temperature

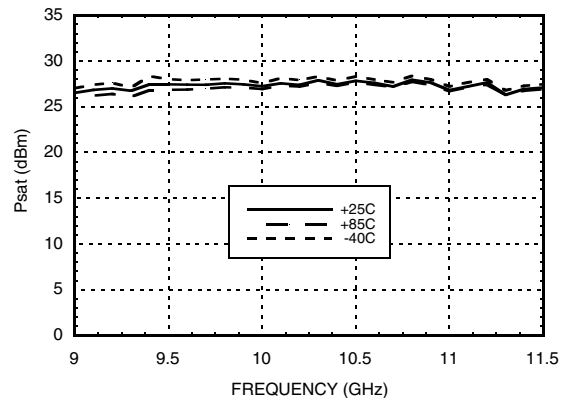



GaAs pHEMT MEDIUM POWER AMPLIFIER, 9.5 - 11.5 GHz

AMPLIFIERS - LINEAR & POWER - SMT

Output IP3 vs. Temperature

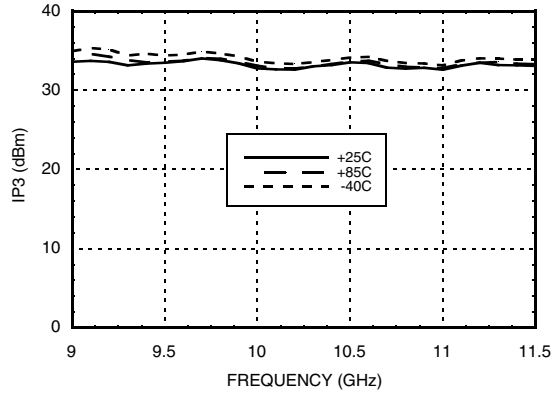

Noise Figure vs. Temperature

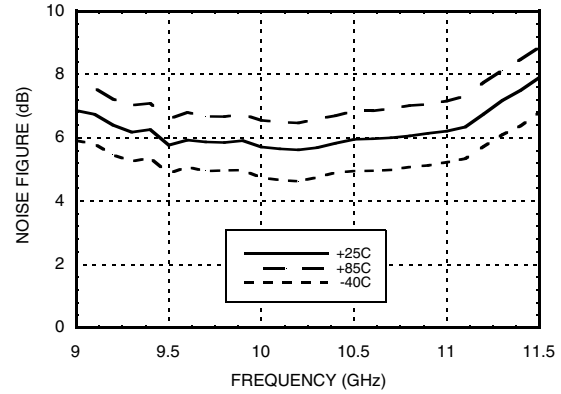

Gain, Power & Output IP3 vs. Supply Voltage @ 10.3 GHz

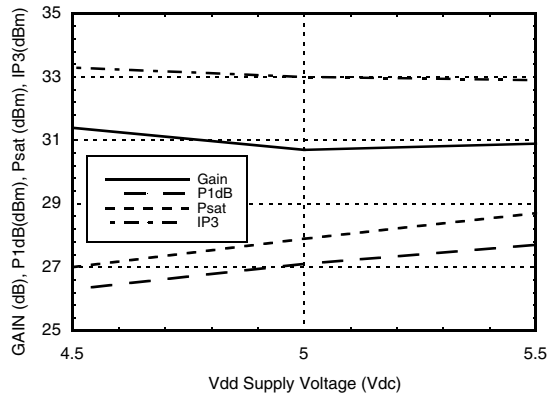

Reverse Isolation vs. Temperature

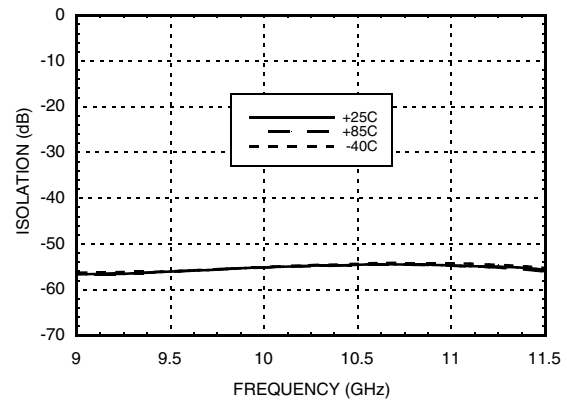

Power Compression @ 10.3 GHz

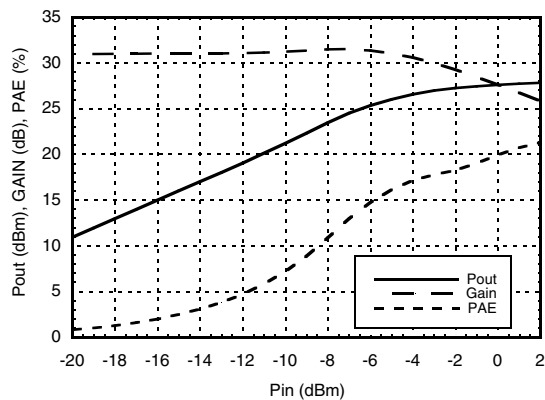

Power Dissipation

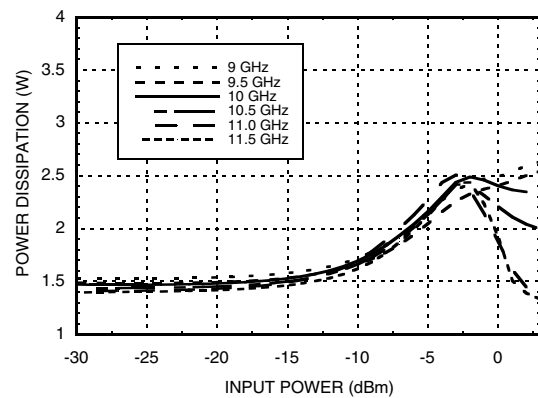

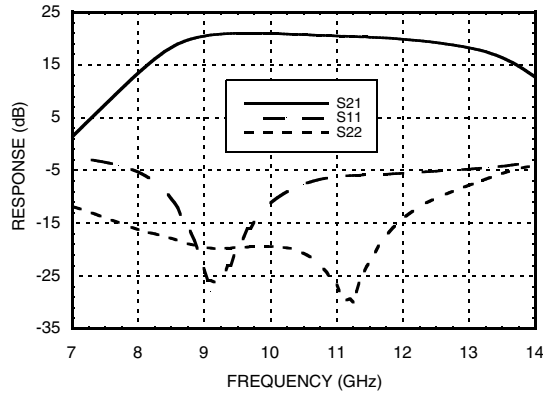
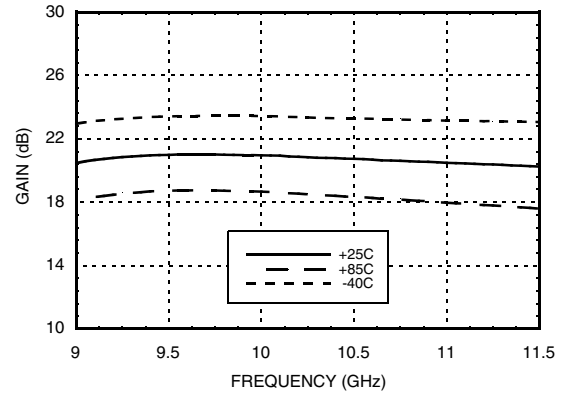
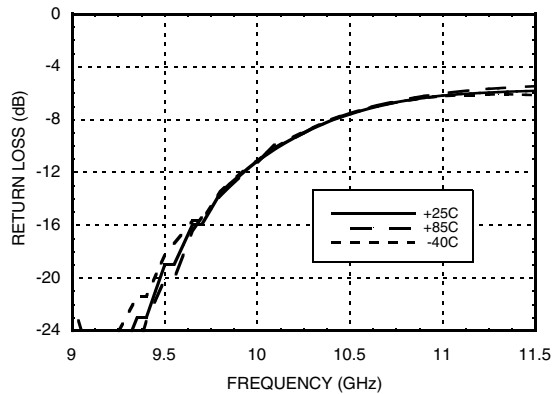
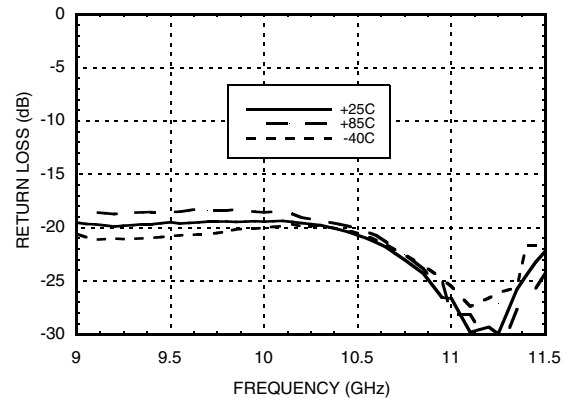
**GaAs pHEMT MEDIUM
POWER AMPLIFIER, 9.5 - 11.5 GHz**
**Low Gain Mode,
Broadband Gain & Return Loss**

Low Gain Mode, Gain vs. Temperature

**Low Gain Mode,
Input Return Loss vs. Temperature**

**Low Gain Mode,
Output Return Loss vs. Temperature**

**GaAs pHEMT MEDIUM
POWER AMPLIFIER, 9.5 - 11.5 GHz**
Absolute Maximum Ratings

| | |
|---|------------------|
| Drain Bias Voltage (Vdd1, Vdd2, Vdd3) | 7 Vdc |
| Gate Bias Voltage (Vgg) | -4.0 to -1.0 Vdc |
| RF Input Power (RFIN)(Vdd = +5Vdc) | +10 dBm |
| Channel Temperature | 175 °C |
| Continuous P _{diss} (T= 85 °C) (derate 22.18 mW/°C above 85 °C) | 2 W |
| Thermal Resistance (channel to ground paddle) | 45 °C/W |
| Storage Temperature | -65 to +150 °C |
| Operating Temperature | -40 to +85 °C |

Typical Supply Current vs. Vdd

| Vdd (Vdc) | I _{dd} (mA) |
|-----------|----------------------|
| +4.5 | 300 |
| +5.0 | 310 |
| +5.5 | 325 |

Note: Amplifier will operate over full voltage ranges shown above. Vgg adjusted to achieve I_{dd}= 310 mA at +5V.

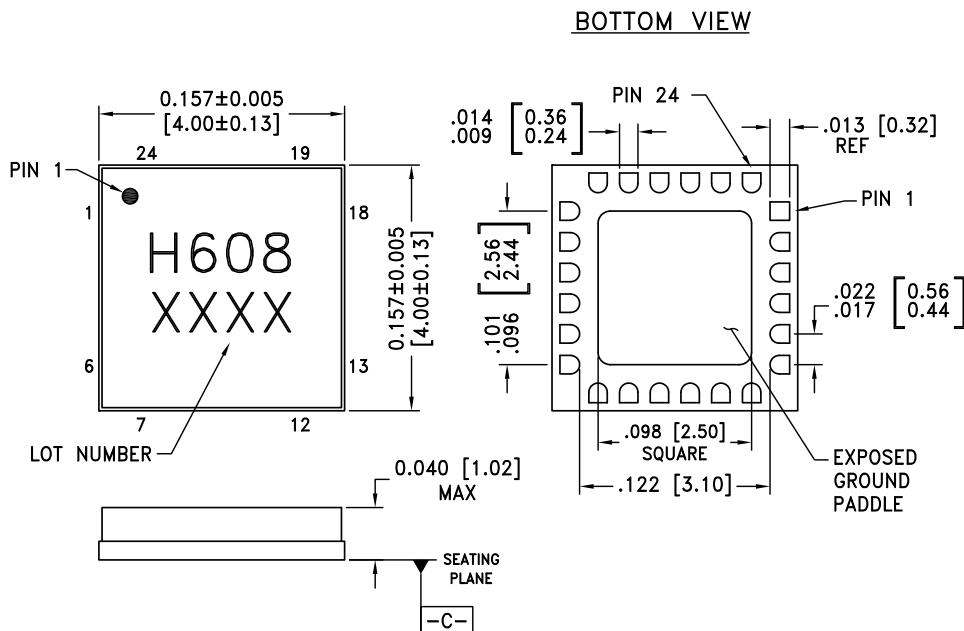

**ELECTROSTATIC SENSITIVE DEVICE
OBSERVE HANDLING PRECAUTIONS**

Outline Drawing

NOTES:

- PACKAGE BODY MATERIAL: ALUMINA.
- LEAD AND GROUND PADDLE PLATING: 30-80 MICROINCHES GOLD OVER 50 MICROINCHES MINIMUM NICKEL
- DIMENSIONS ARE IN INCHES (MILLIMETERS).
- LEAD SPACING TOLERANCE IS NON-CUMULATIVE.
- CHARACTERS TO BE HELVETICA MEDIUM, .025 HIGH, BLACK INK, OR LASER MARK LOCATED APPROX. AS SHOWN.
- PACKAGE WARP SHALL NOT EXCEED 0.05MM DATUM ---C---
- ALL GROUND LEADS AND GROUND PADDLE MUST BE SOLDERED TO PCB RF GROUND.



Package Information

| Part Number | Package Body Material | Lead Finish | MSL Rating | Package Marking ^[2] |
|-------------|-----------------------|------------------|---------------------|--------------------------------|
| HMC608LC4 | Alumina, White | Gold over Nickel | MSL3 ^[1] | H608 XXXX |

[1] Max peak reflow temperature of 260 °C

[2] 4-Digit lot number XXXX

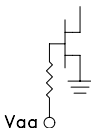
Pin Descriptions

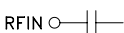
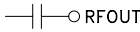
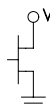
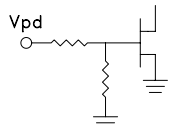
| Pin Number | Function | Description | Interface Schematic |
|----------------------------------|--|---|--|
| 1 | V _{gg} | Gate control for amplifier. Adjust to achieve I _d of 310 mA. Please follow "MMIC Amplifier Biasing Procedure" Application Note. External bypass capacitors of 100 pF, 1000 pF and 2.2 μF are required. |  |
| 2, 3, 7 - 12, 16 - 18, 22, 24 | N/C | No connection required. These pins may be connected to RF/DC ground without affecting performance. | |
| 4, 6, 13, 15 | GND | Package bottom has an exposed metal paddle that must also be connected to RF/DC ground. |  |
| 5 | RFIN | This pin is AC coupled and matched to 50 Ohms. |  |
| 14 | RFOUT | This pin is AC coupled and matched to 50 Ohms. |  |
| 21, 20, 19 | V _{dd1} , V _{dd2} , V _{dd3} | Power Supply Voltage for the amplifier. External bypass capacitors of 100 pF, 1000pF, and 2.2 μF are required. |  |
| 23 | V _{pd} | High gain (connect to ground) / low gain mode pin control (open circuit). External bypass capacitors of 100 pF, 1000 pF and 2.2 μF are required. |  |

Evaluation PCB

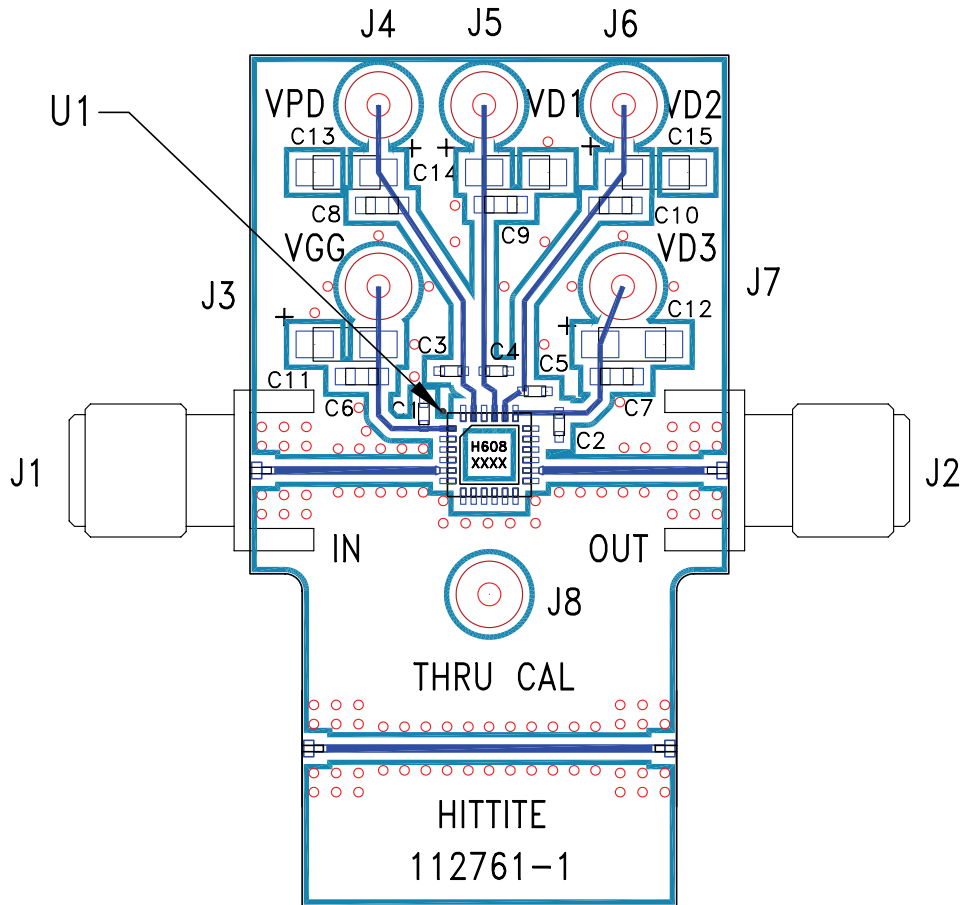

List of Materials for Evaluation PCB 112763 [1]

| Item | Description |
|-----------|-------------------------------|
| J1, J2 | PC mount SMA connector |
| J3 - J8 | DC Pin |
| C1 - C6 | 100 pF capacitor, 0402 pkg. |
| C6 - C10 | 1,000 pF Capacitor, 0603 pkg. |
| C11 - C15 | 2.2µF Capacitor, Tantalum |
| U1 | HMC608LC4 Amplifier |
| PCB [2] | 112761 Evaluation PCB |

[1] Reference this number when ordering complete evaluation PCB

[2] Circuit Board Material: Rogers 4350.

The circuit board used in this application should use RF circuit design techniques. Signal lines should have 50 Ohm impedance while the package ground leads and exposed paddle should be connected directly to the ground plane similar to that shown. A sufficient number of via holes should be used to connect the top and bottom ground planes. The evaluation board should be mounted to an appropriate heat sink. The evaluation circuit board shown is available from Hittite upon request.



**GaAs pHEMT MEDIUM
POWER AMPLIFIER, 9.5 - 11.5 GHz**