

Analog Devices Welcomes Hittite Microwave Corporation

NO CONTENT ON THE ATTACHED DOCUMENT HAS CHANGED



HMC740* Product Page Quick Links

Last Content Update: 11/01/2016

[Comparable Parts](#)

View a parametric search of comparable parts

[Evaluation Kits](#)

- HMC740ST89E Evaluation Board

[Documentation](#)

Application Notes

- AN-1363: Meeting Biasing Requirements of Externally Biased RF/Microwave Amplifiers with Active Bias Controllers

Data Sheet

- HMC740 Data Sheet

[Tools and Simulations](#)

- HMC740 S-Parameter

[Reference Materials](#)

Quality Documentation

- Package/Assembly Qualification Test Report: 3 Lead Plastic SOT89 Package (QTR: 10002 REV: 02)
- Semiconductor Qualification Test Report: GaAs HBT-E (QTR: 2013-00271)

[Design Resources](#)

- HMC740 Material Declaration
- PCN-PDN Information
- Quality And Reliability
- Symbols and Footprints

[Discussions](#)

View all HMC740 EngineerZone Discussions

[Sample and Buy](#)

Visit the product page to see pricing options

[Technical Support](#)

Submit a technical question or find your regional support number

THIS PAGE INTENTIONALLY LEFT BLANK

Typical Applications

The HMC740ST89E is ideal for:

- Cellular/3G & WiMAX/4G
- Fixed Wireless & WLAN
- CATV, Cable Modem & DBS
- Microwave Radio & Test Equipment
- IF & RF Applications

Features

- P1dB Output Power: +18 dBm
- Gain: 15 dB
- Output IP3: +40 dBm
- Cascadable 50 Ohm I/Os
- Single Supply: +5V
- Industry Standard SOT89 Package
- Robust 1000V ESD, Class 1C
- Stable Current Over Temperature
- Active Bias Network

Functional Diagram

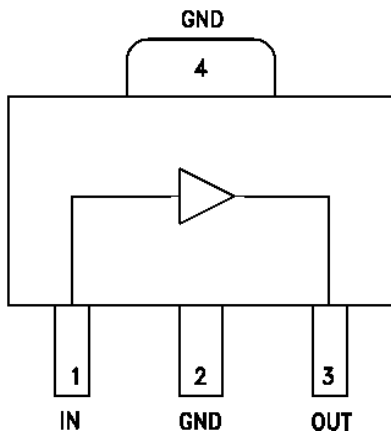

General Description

The HMC740ST89E is an InGaP Heterojunction Bipolar Transistor (HBT) Gain Block MMIC SMT amplifier covering 0.05 to 3 GHz. Packaged in an industry standard SOT89, the amplifier can be used as a cascadable 50 Ohm RF or IF gain stage as well as a PA or LO driver with up to +18 dBm output power. The HMC740ST89E offers 15 dB of gain with a +40 dBm output IP3 at 100 MHz, and can operate directly from a +5V supply. The HMC740ST89E exhibits excellent gain and output power stability over temperature, while requiring a minimal number of external bias components.

Electrical Specifications, $V_{cc} = 5V$, $T_A = +25^\circ C$

| Parameter | Min. | Typ. | Max. | Min. | Typ. | Max. | Units |
|---|----------|-----------|----------|------|-----------|-------|-------|
| Frequency Range | 0.05 - 1 | | 0.05 - 3 | | | | GHz |
| Gain | 12 | 15 | | 11 | 15 | | dB |
| Gain Flatness | | ± 0.1 | | | ± 0.7 | | dB |
| Gain Variation over Temperature | | 0.003 | 0.006 | | 0.003 | 0.006 | dB/°C |
| Input Return Loss | | 18 | | | 15 | | dB |
| Output Return Loss | | 18 | | | 18 | | dB |
| Reverse Isolation | | 20 | | | 21 | | dB |
| Output Power for 1 dB Compression (P1dB) | 15.5 | 18 | | 14.5 | 17 | | dBm |
| Output Third Order Intercept (IP3) (Pout= 0 dBm per tone, 1 MHz spacing) | | 38 | | | 32 | | dBm |
| Noise Figure | | 3.5 | | | 3.5 | | dB |
| Supply Current (Icq) | | 88 | | | 88 | | mA |

IF Band Performance

Gain & Return Loss

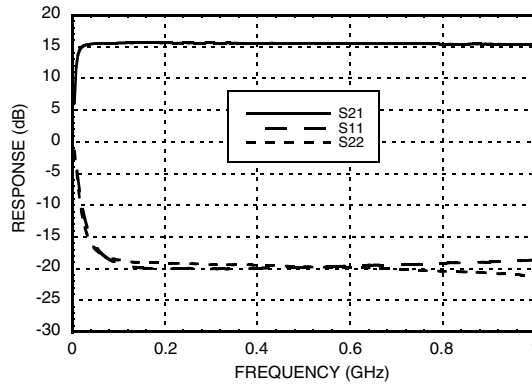

Gain vs. Temperature

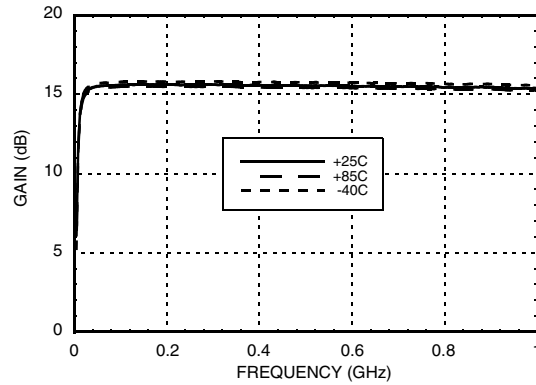

Noise Figure vs. Temperature

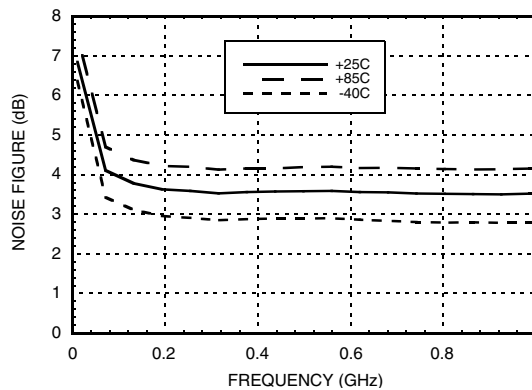

Output IP3 vs. Temperature

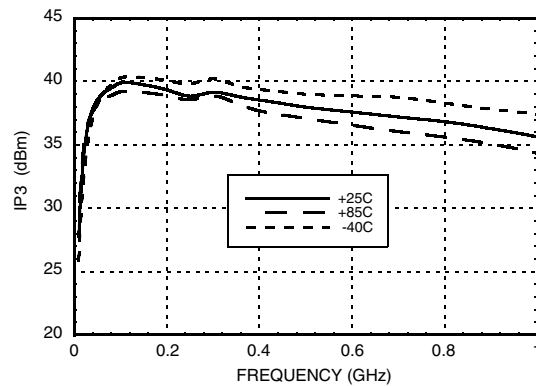

Output IP3 vs. Vcc

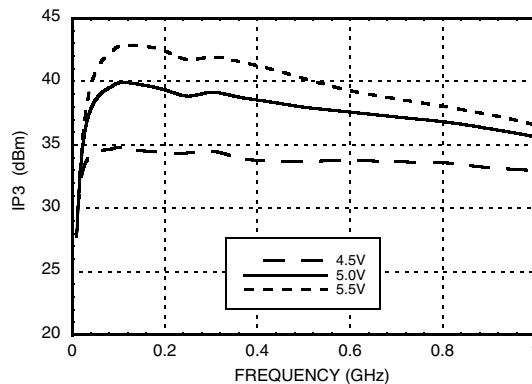

Output IP3 vs. Output Power

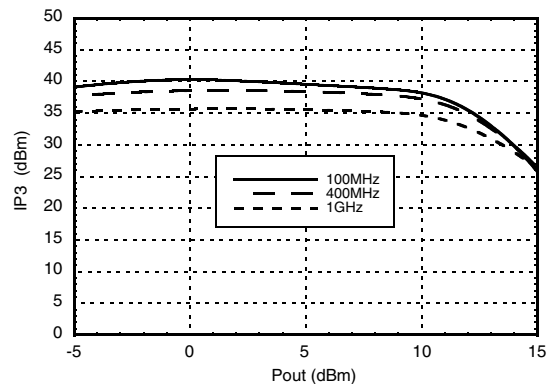



Broadband Performance

Gain & Return Loss

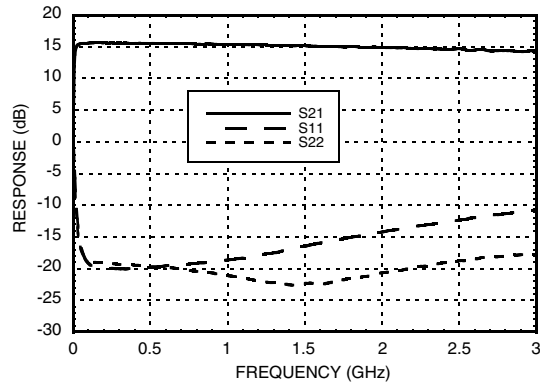

Gain vs. Temperature

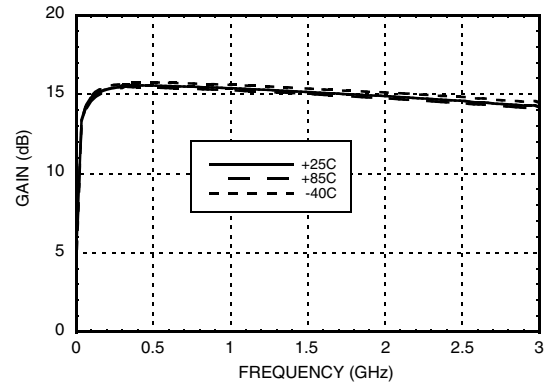

Gain vs. Vcc

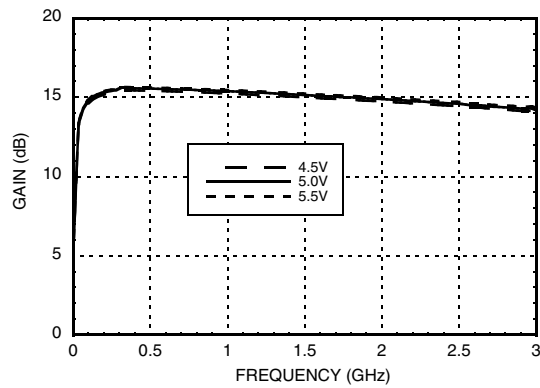

Input Return Loss vs. Temperature

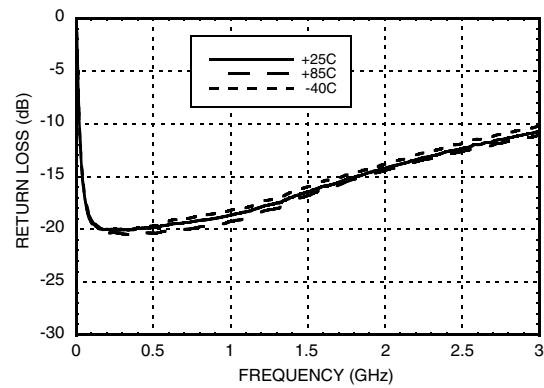

Output Return Loss vs. Temperature

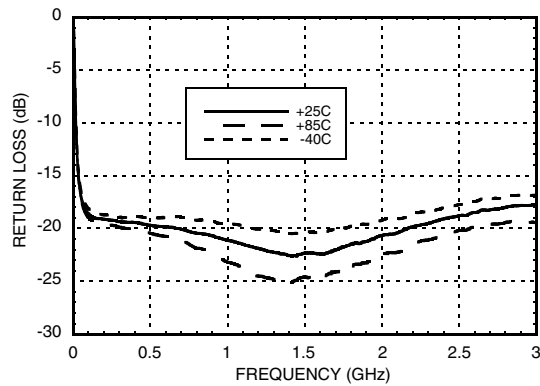

Input Return Loss vs. Vcc

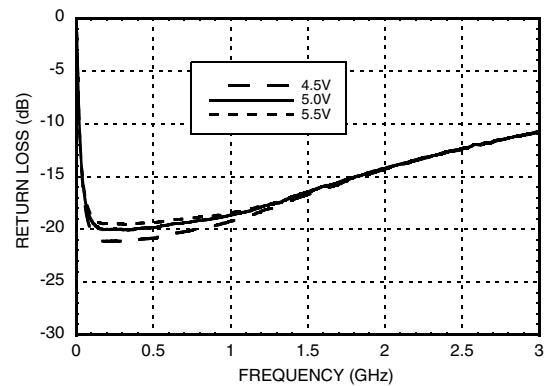

InGaP HBT ACTIVE BIAS MMIC AMPLIFIER, 0.05 – 3 GHz

Output Return Loss vs. Vcc

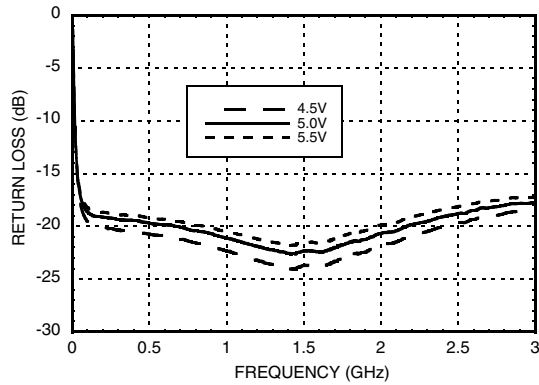

Noise Figure vs. Temperature

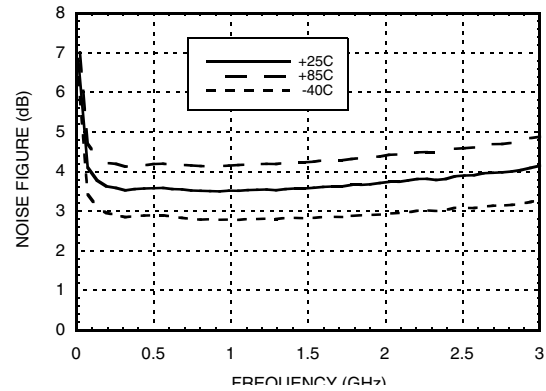

Noise Figure vs. Vcc

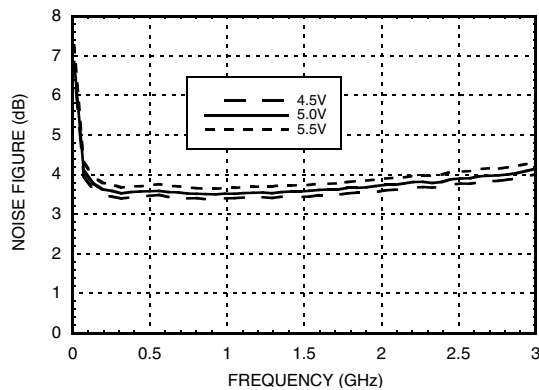

Reverse Isolation vs. Temperature

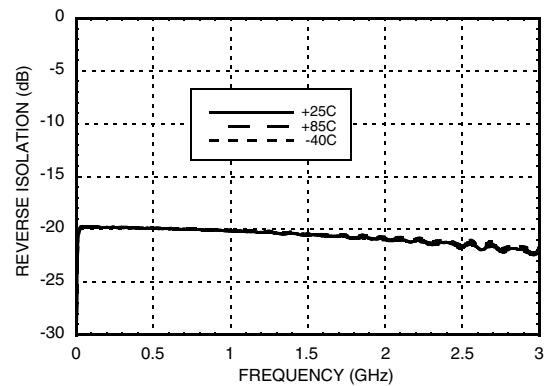

Reverse Isolation vs. Vcc

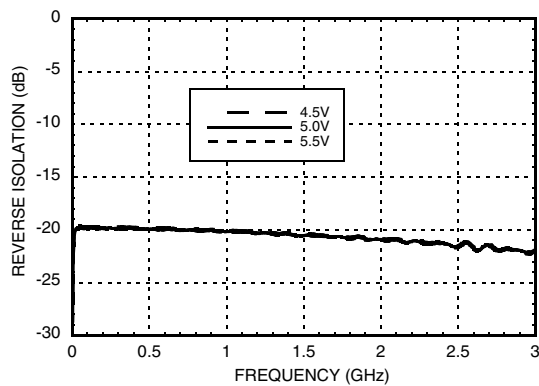

Output IP3 vs. Temperature

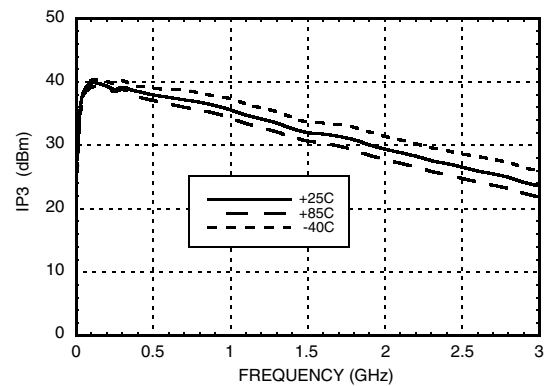

InGaP HBT ACTIVE BIAS MMIC AMPLIFIER, 0.05 – 3 GHz

Output IP3 vs. Vcc

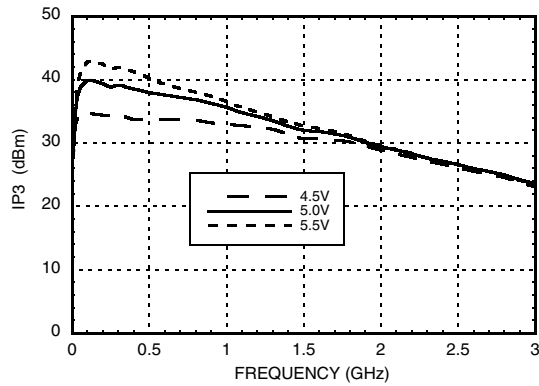

Current vs. Temperature

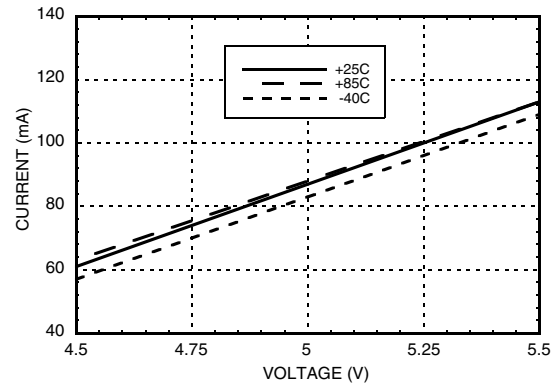

P1dB vs. Temperature

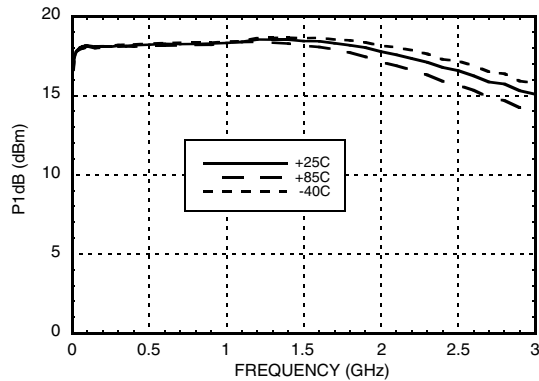

Psat vs. Temperature

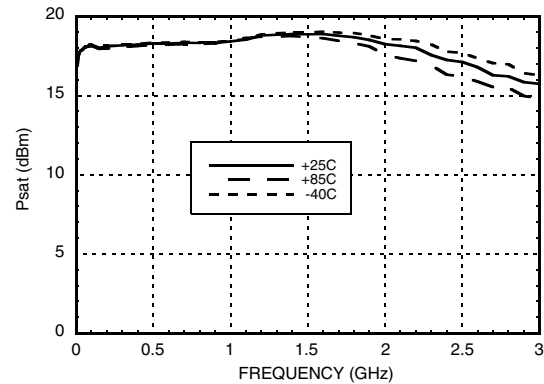

Power Compression @ 500 MHz

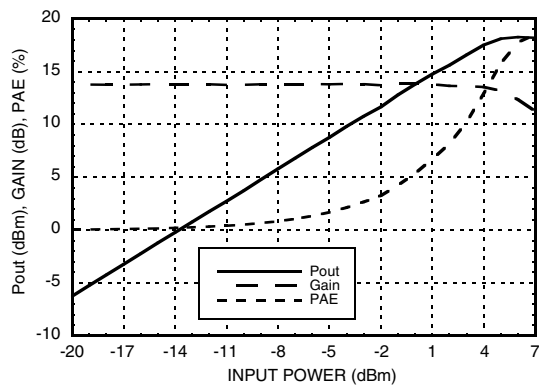

Power Compression @ 2 GHz

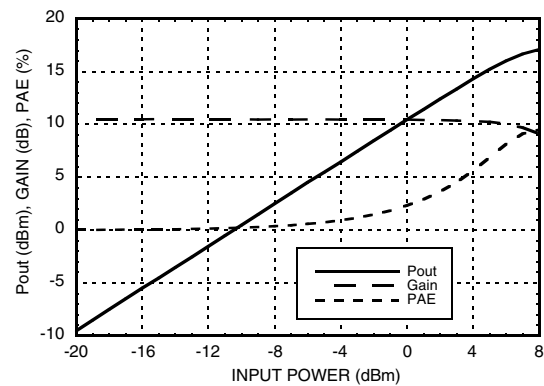

Absolute Maximum Ratings

| | |
|--|----------------|
| Collector Bias Voltage (Vcc) | +5.5 Vdc |
| RF Input Power (RFIN) | +15 dBm |
| Junction Temperature | 150 °C |
| Continuous Pdiss (T = 85 °C) (derate 10.23 mW/°C above 85 °C) | 0.66 W |
| Thermal Resistance (junction to lead) | 97.78 °C/W |
| Storage Temperature | -65 to +150 °C |
| Operating Temperature | -40 to +85 °C |
| ESD Sensitivity (HMB) | Class 1C |



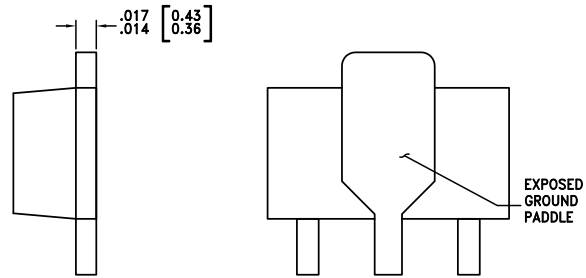
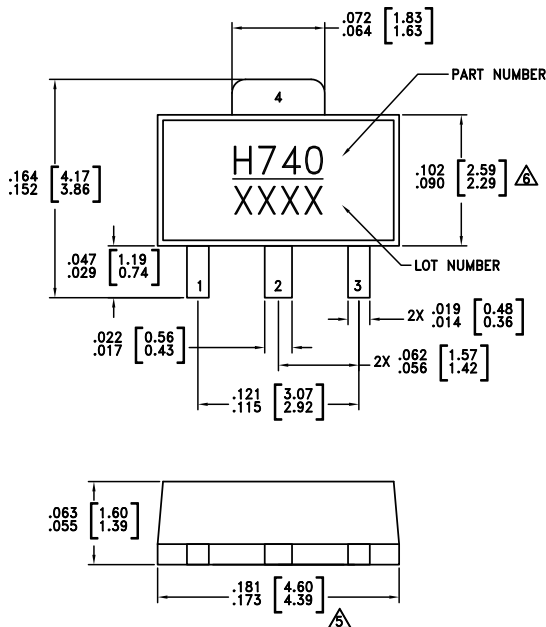

ELECTROSTATIC SENSITIVE DEVICE
OBSERVE HANDLING PRECAUTIONS

Outline Drawing



NOTES:

- PACKAGE BODY MATERIAL:
MOLDING COMPOUND MP-180S OR EQUIVALENT.
- LEAD MATERIAL: Cu w/ Ag SPOT PLATING.
- LEAD PLATING: 100% MATTE TIN.
- DIMENSIONS ARE IN INCHES [MILLIMETERS]
-  DIMENSION DOES NOT INCLUDE MOLDFLASH OF 0.15mm PER SIDE.
-  DIMENSION DOES NOT INCLUDE MOLDFLASH OF 0.25mm PER SIDE.
- ALL GROUND LEADS MUST BE SOLDERED TO PCB RF GROUND.



Package Information

| Part Number | Package Body Material | Lead Finish | MSL Rating | Package Marking ^[1] |
|-------------|--|---------------|---------------------|--------------------------------|
| HMC740ST89E | RoHS-compliant Low Stress Injection Molded Plastic | 100% matte Sn | MSL1 ^[2] | H740 XXXX |

[1] 4-Digit lot number XXXX

[2] Max peak reflow temperature of 260 °C

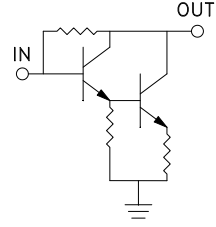
Pin Descriptions

| Pin Number | Function | Description | Interface Schematic |
|------------|----------|---|---|
| 1 | IN | This pin is DC coupled. An off chip DC blocking capacitor is required. |  |
| 3 | OUT | RF output and DC Bias (Vcc) for the output stage. | |
| 2, 4 | GND | These pins and package bottom must be connected to RF/DC ground. |  |

Application Circuit

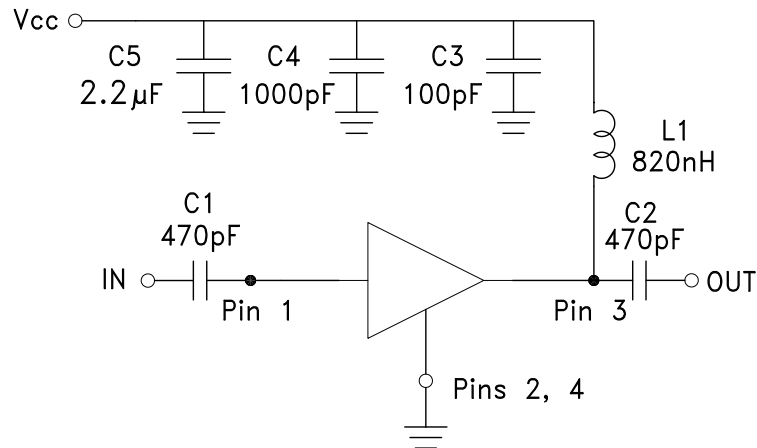

Evaluation PCB

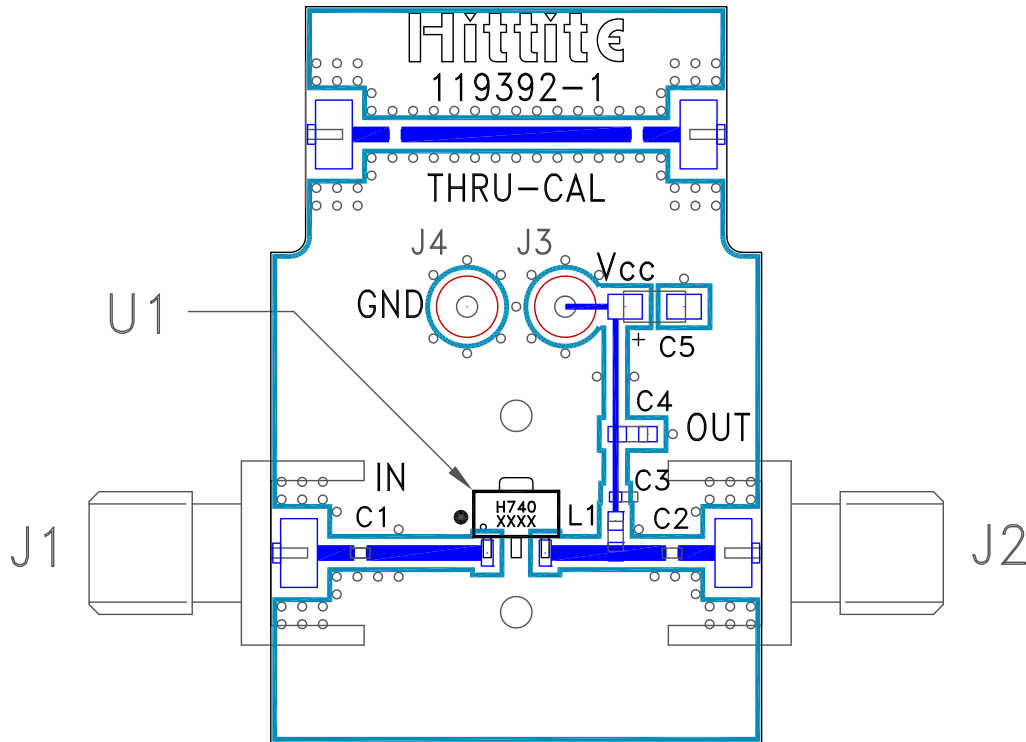

List of Materials for Evaluation PCB 124390 [1]

| Item | Description |
|---------|--------------------------------|
| J1, J2 | PCB Mount SMA Connector |
| J3, J4 | DC Pin |
| C1, C2 | 470 pF Capacitor, 0402 Pkg. |
| C3 | 100 pF Capacitor, 0402 Pkg. |
| C4 | 1000 pF Capacitor, 0603 Pkg. |
| C5 | 2.2 μ F Capacitor Tantalum |
| L1 | 820 nH Inductor, 0603 Pkg. |
| U1 | HMC740ST89E |
| PCB [2] | 119392 Evaluation PCB |

[1] Reference this number when ordering complete evaluation PCB

[2] Circuit Board Material: FR4

The circuit board used in the final application should use RF circuit design techniques. Signal lines should have 50 Ohm impedance while the package ground leads and package bottom should be connected directly to the ground plane similar to that shown. A sufficient number of via holes should be used to connect the top and bottom ground planes. The evaluation board should be mounted to an appropriate heat sink. The evaluation circuit board shown is available from Hittite upon request.