

Analog Devices Welcomes Hittite Microwave Corporation

NO CONTENT ON THE ATTACHED DOCUMENT HAS CHANGED



HMC241ALP3E* Product Page Quick Links

Last Content Update: 11/01/2016

[Comparable Parts](#)

View a parametric search of comparable parts

[Evaluation Kits](#)

- [HMC241ALP3 Evaluation Board](#)

[Documentation](#)

Data Sheet

- [HMC241ALP3 Data Sheet](#)

[Design Resources](#)

- [HMC241ALP3E Material Declaration](#)
- [PCN-PDN Information](#)
- [Quality And Reliability](#)
- [Symbols and Footprints](#)

[Discussions](#)

View all HMC241ALP3E EngineerZone Discussions

[Sample and Buy](#)

Visit the product page to see pricing options

[Technical Support](#)

Submit a technical question or find your regional support number

THIS PAGE INTENTIONALLY LEFT BLANK

Typical Applications

The HMC241ALP3E is ideal for:

- Base Stations & Repeaters
- WLAN, WiMAX & WiBro
- CATV / DBS
- Test Equipment

Functional Diagram

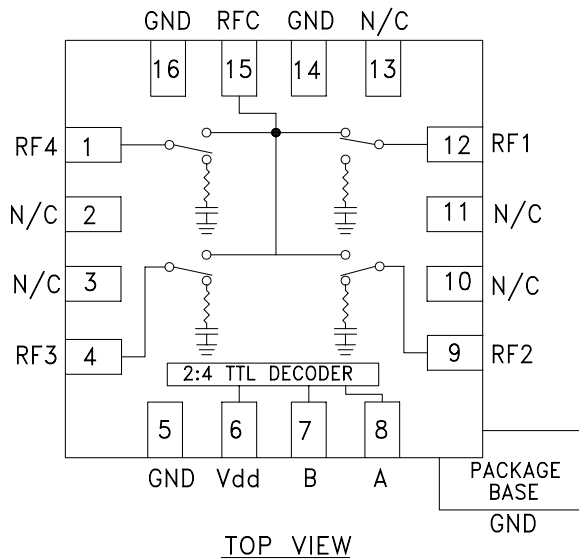

Features

- High Isolation: 43 dB @ 2 GHz
- Low Insertion Loss: 0.7 dB @ 2 GHz
- Single Positive Supply: $V_{dd} = +5V$
- Integrated 2:4 TTL Decoder
- 16 Lead 3x3mm SMT Package: 9mm²

General Description

The HMC241ALP3E is a general purpose non-reflective SP4T switch in a low cost leadless surface mount package. Covering DC - 4 GHz, this switch offers high isolation and has a low insertion loss of 0.7 dB at 2 GHz. The switch offers a single positive bias and true TTL/CMOS compatibility. A 2:4 decoder is integrated on the switch requiring only 2 control lines and a positive bias to select each path, replacing 4 to 8 control lines normally required by GaAs SP4T switches.

Electrical Specifications, $T_A = +25^\circ C$, For TTL Control and $V_{dd} = +5V$ in a 50 Ohm System

Parameter	Frequency	Min.	Typ.	Max.	Units
Insertion Loss	DC - 1.0 GHz		0.6	0.9	dB
	DC - 2.0 GHz		0.7	1.0	dB
	DC - 2.5 GHz		0.9	1.2	dB
	DC - 4.0 GHz		1.2	1.5	dB
Isolation	DC - 1.0 GHz	40	45		dB
	DC - 2.0 GHz	38	43		dB
	DC - 2.5 GHz	35	41		dB
	DC - 4.0 GHz	25	32		dB
Return Loss	"On State"	DC - 2.5 GHz	18		dB
		DC - 4.0 GHz	12		dB
Return Loss	RF1-4 "Off State"	0.3 - 4.0 GHz	12		dB
Input Power for 1dB Compression	0.3 - 4.0 GHz	23	29		dBm
Input Third Order Intercept (Two-Tone Input Power = +10 dBm Each Tone)	0.3 - 4.0 GHz		47		dBm
Switching Characteristics	0.3 - 4.0 GHz				
		tRISE, tFALL (10/90% RF) tON, tOFF (50% CTL to 10/90% RF)		30 100	ns ns



GaAs MMIC SP4T NON-REFLECTIVE SWITCH, DC - 4 GHz

Insertion Loss

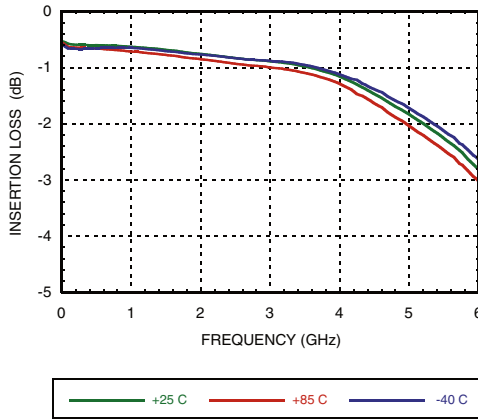

Isolation

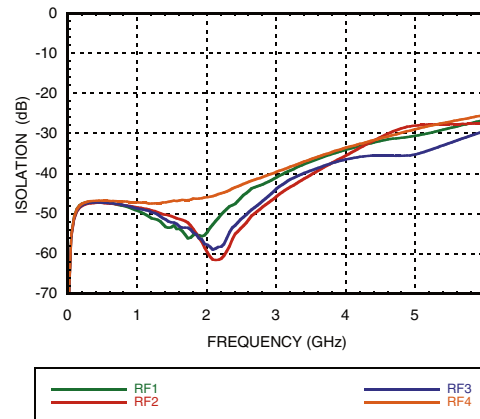

Return Loss

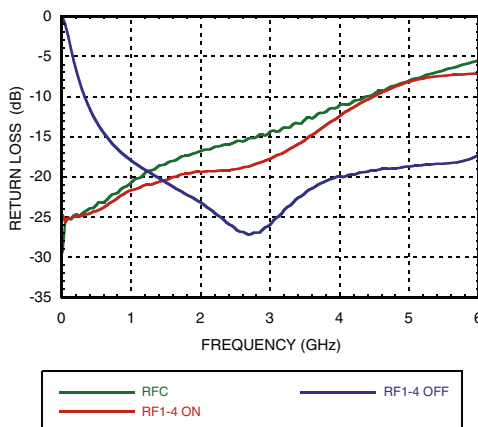

0.1 and 1 dB Input Compression Point

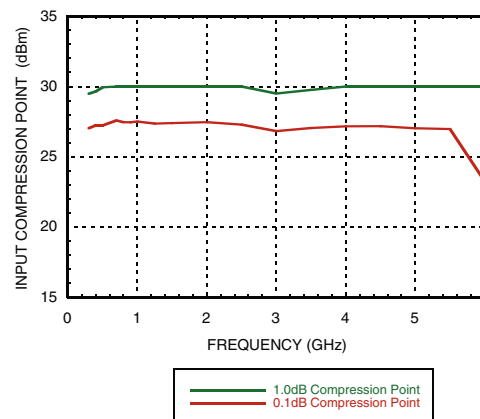

Input Third Order Intercept Point

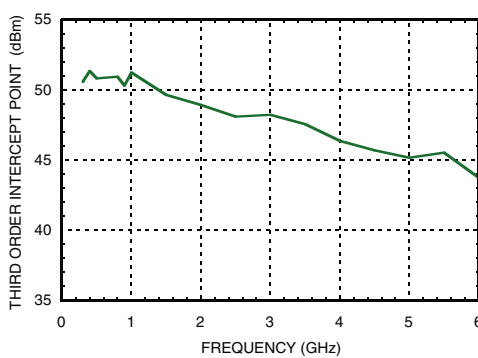

Bias Voltage & Current

Vdd Range = +5.0 Vdc ± 10%		
Vdd (Vdc)	Idd (Typ.) (mA)	Idd (Max.) (mA)
+5.0	2.5	5.0

TTL/CMOS Control Voltages

State	Bias Condition
Low	0 to +0.8 Vdc @ 0.2µA Typ.
High	+2.0 to +5.0 Vdc @ 40 µA Typ.

NOTE: DC Blocking capacitors are required at ports RFC and RF1, 2, 3, 4.

Absolute Maximum Ratings

Bias Voltage Range (Vdd)	+7.0 Vdc
Control Voltage Range (A & B)	-0.5V to Vdd +1 Vdc
Channel Temperature	150 °C
Thermal Resistance	
Insertion Loss Path	144 °C/W
Terminated Path	300 °C/W
Storage Temperature	-65 to +150 °C
Operating Temperature	-40 to +85 °C
Maximum Input Power Vdd = +5 Vdc	
Insertion Loss Path	+28.5 dBm
Terminated Path	+25 dBm
ESD Sensitivity (HBM)	Class 1A

Truth Table

Control Input		Signal Path State
A	B	RFC to:
LOW	LOW	RF1
HIGH	LOW	RF2
LOW	HIGH	RF3
HIGH	HIGH	RF4



**ELECTROSTATIC SENSITIVE DEVICE
OBSERVE HANDLING PRECAUTIONS**

Outline Drawing

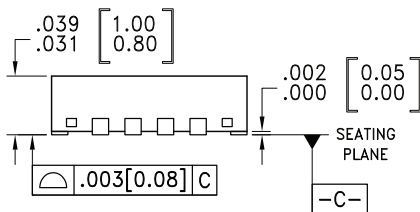
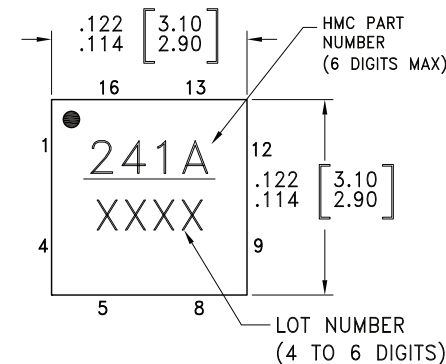

BOTTOM VIEW

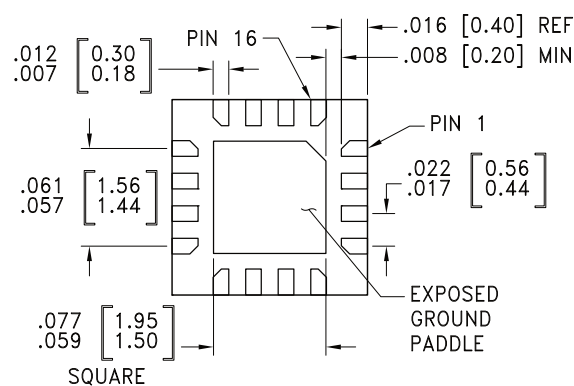

1. LEADFRAME MATERIAL: COPPER ALLOY
2. DIMENSIONS ARE IN INCHES [MILLIMETERS]
3. LEAD SPACING TOLERANCE IS NON-CUMULATIVE
4. PAD BURR LENGTH SHALL BE 0.15mm MAXIMUM.
PAD BURR HEIGHT SHALL BE 0.05mm MAXIMUM.
5. PACKAGE WARP SHALL NOT EXCEED 0.05mm.
6. ALL N/C LEADS, GROUND LEADS AND GROUND PADDLE MUST BE SOLDERED TO PCB RF GROUND.
7. REFER TO HITTITE APPLICATION NOTE FOR SUGGESTED LAND PATTERN.

Package Information

Part Number	Package Body Material	Leadframe Plating	MSL Rating	Package Marking ^[2]
HMC241ALP3E	RoHS-compliant Low Stress Injection Molded Plastic	100% Matte Tin	MSL1 ^[1]	241A XXXX

[1] Max peak reflow temperature of 260 °C

[2] 4-Digit lot number XXXX

Pin Descriptions

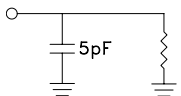
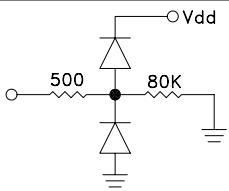
Pin Number	Function	Description	Interface Schematic
1, 4, 9, 12, 15	RF4, RF3, RF2, RF1, RFC	This Pin is DC coupled and matched to 50 Ohm. Blocking capacitors are required.	
2, 3, 10, 11, 13	N/C	This pin should be connected to PCB RF ground to maximize isolation.	
5, 14, 16	GND	Package bottom has exposed metal paddle that must also be connected to PCB RF ground.	
6	Vdd	Supply Voltage +5V ± 10%	
7	B	See truth table and control voltage table.	
8	A	See truth table and control voltage table.	

Evaluation PCB

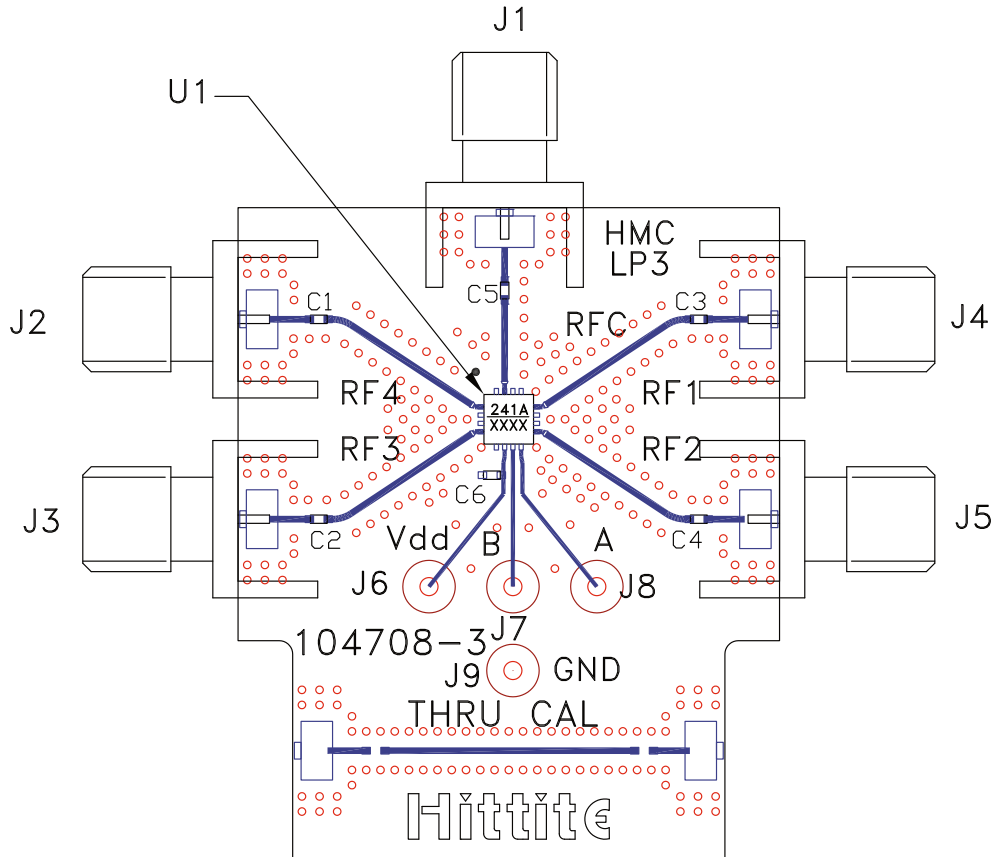

List of Materials for Evaluation PCB EVAL01 - HMC241ALP3 [1]

Item	Description
J1 - J5	PCB Mount SMA RF Connector
J6 - J9	DC Pin
C1 - C5	100 pF Capacitor, 0402 Pkg.
C6	10k pF Capacitor, 0603 Pkg.
U1	HMC241ALP3E SP4T Switch
PCB [2]	104708 Evaluation PCB

[1] Reference this number when ordering complete evaluation PCB

[2] Circuit Board Material: Rogers 4350

The circuit board used in the application should be generated with proper RF circuit design techniques. Signal lines at the RF port should have 50 ohm impedance and the package ground leads and package bottom should be connected directly to the ground plane similar to that shown above. The evaluation circuit board shown above is available from Hittite Microwave Corporation upon request.

