



Is Now Part of



ON Semiconductor®

To learn more about ON Semiconductor, please visit our website at
www.onsemi.com

ON Semiconductor and the ON Semiconductor logo are trademarks of Semiconductor Components Industries, LLC dba ON Semiconductor or its subsidiaries in the United States and/or other countries. ON Semiconductor owns the rights to a number of patents, trademarks, copyrights, trade secrets, and other intellectual property. A listing of ON Semiconductor's product/patent coverage may be accessed at www.onsemi.com/site/pdf/Patent-Marking.pdf. ON Semiconductor reserves the right to make changes without further notice to any products herein. ON Semiconductor makes no warranty, representation or guarantee regarding the suitability of its products for any particular purpose, nor does ON Semiconductor assume any liability arising out of the application or use of any product or circuit, and specifically disclaims any and all liability, including without limitation special, consequential or incidental damages. Buyer is responsible for its products and applications using ON Semiconductor products, including compliance with all laws, regulations and safety requirements or standards, regardless of any support or applications information provided by ON Semiconductor. "Typical" parameters which may be provided in ON Semiconductor data sheets and/or specifications can and do vary in different applications and actual performance may vary over time. All operating parameters, including "Typicals" must be validated for each customer application by customer's technical experts. ON Semiconductor does not convey any license under its patent rights nor the rights of others. ON Semiconductor products are not designed, intended, or authorized for use as a critical component in life support systems or any FDA Class 3 medical devices or medical devices with a same or similar classification in a foreign jurisdiction or any devices intended for implantation in the human body. Should Buyer purchase or use ON Semiconductor products for any such unintended or unauthorized application, Buyer shall indemnify and hold ON Semiconductor and its officers, employees, subsidiaries, affiliates, and distributors harmless against all claims, costs, damages, and expenses, and reasonable attorney fees arising out of, directly or indirectly, any claim of personal injury or death associated with such unintended or unauthorized use, even if such claim alleges that ON Semiconductor was negligent regarding the design or manufacture of the part. ON Semiconductor is an Equal Opportunity/Affirmative Action Employer. This literature is subject to all applicable copyright laws and is not for resale in any manner.



September 2014

LM350

3-Terminal 3 A Positive Adjustable Regulator

Features

- Output Adjustable Between 1.2 V and 33 V
- Guaranteed 3 A Output Current
- Internal Thermal Overload Protection
- Load Regulation (Typical: 0.1%)
- Line Regulation (Typical: 0.015%/V)
- Internal Short-Circuit Current Limit
- Output Transistor Safe-Area Compensation

Description

The LM350 is an adjustable 3-terminal positive voltage regulator capable of supplying in excess of 3.0 A over an output voltage range of 1.2 V to 33 V.

TO-220 (Single Gauge)

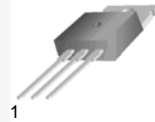

1. Adj 2. Output 3. Input

Ordering Information

Product Number	Marking	Package	Packing Method	Operating Temperature
LM350T	LM350	TO-220 3L (Single Gauge)	Rail	0 to +125°C

LM350 — 3-Terminal 3 A Positive Adjustable Regulator

Block Diagram

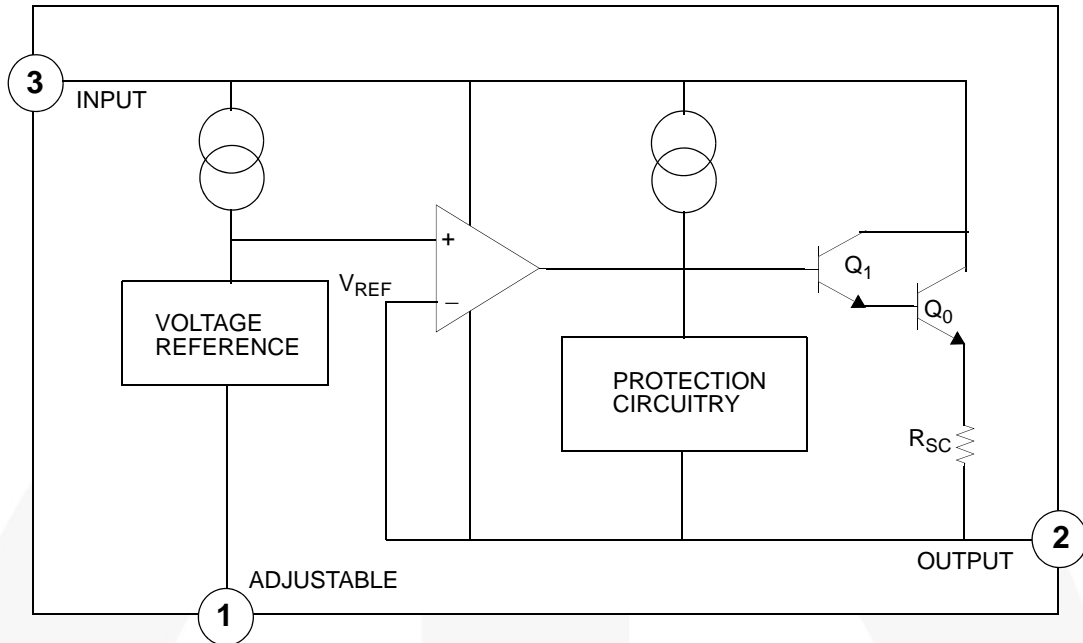

Figure 1. Block Diagram

Absolute Maximum Ratings

Stresses exceeding the absolute maximum ratings may damage the device. The device may not function or be operable above the recommended operating conditions and stressing the parts to these levels is not recommended. In addition, extended exposure to stresses above the recommended operating conditions may affect device reliability. The absolute maximum ratings are stress ratings only. Values are at $T_A = 25^\circ\text{C}$ unless otherwise noted.

Symbol	Parameter	Value	Unit
$V_I - V_O$	Input-Output Voltage Differential	35	V
T_{LEAD}	Lead Temperature (Soldering, 10 sec)	300	$^\circ\text{C}$
T_{OPR}	Operating Temperature Range	0 to +125	$^\circ\text{C}$
T_{STG}	Storage Temperature Range	-65 to +150	$^\circ\text{C}$

Thermal Characteristics

Values are at $T_A = 25^\circ\text{C}$ unless otherwise noted.

Symbol	Parameter	Value	Unit
P_D	Power Dissipation	Internally Limited	W

Electrical Characteristics

$V_I - V_O = 5\text{ V}$, $I_O = 1.5\text{ A}$, $0^\circ\text{C} \leq T_J \leq +125^\circ\text{C}$, $P_D \leq P_{D\text{MAX}}$, unless otherwise specified.

Symbol	Parameter	Conditions	Min.	Typ.	Max.	Unit
Rline	Line Regulation ⁽¹⁾	$T_A = +25^\circ\text{C}$, $3\text{ V} \leq V_I - V_O \leq 35\text{ V}$		0.015	0.030	%/V
Rload	Load Regulation ⁽¹⁾	$T_A = +25^\circ\text{C}$, $3\text{ V} \leq V_I - V_O \leq 35\text{ V}$, $V_O \leq 5\text{ V}$		5	25	mV
		$T_A = +25^\circ\text{C}$, $3\text{ V} \leq V_I - V_O \leq 35\text{ V}$, $V_O \geq 5\text{ V}$		0.1	0.5	%
I_{ADJ}	Adjustment Pin Current	-		50	100	μA
ΔI_{ADJ}	Adjustment Pin Current Change	$3\text{ V} \leq V_I - V_O \leq 35\text{ V}$, $10\text{ mA} \leq I_O \leq 3\text{ A}$, $P_D \leq P_{\text{MAX}}$		0.2	5.0	μA
REG _T	Thermal Regulation	Pulse = 20 ms, $T_A = +25^\circ\text{C}$		0.002		%/W
V_{REF}	Reference Voltage	$3\text{ V} \leq V_I - V_O \leq 35\text{ V}$, $10\text{ mA} \leq I_O \leq 3\text{ A}$, $P_D \leq 30\text{ W}$	1.20	1.25	1.30	V
Rline	Line Regulation	$3.0\text{ V} \leq V_I - V_O \leq 35\text{ V}$		0.02	0.07	%/V
Rload	Load Regulation	$10\text{ mA} \leq I_O \leq 3.0\text{ A}$, $V_O \leq 5.0\text{ V}$		20	70	mV
		$10\text{ mA} \leq I_O \leq 3.0\text{ A}$, $V_O \geq 5.0\text{ V}$		0.3	1.5	%
ST _T	Temperature Stability	$T_J = 0^\circ\text{C}$ to $+125^\circ\text{C}$		1.0		%
$I_{\text{O(MAX)}}$	Maximum Output Current	$V_I - V_O \leq 10\text{ V}$, $P_D \leq P_{\text{MAX}}$	3.0	4.5		A
		$V_I - V_O = 30\text{ V}$, $P_D \leq P_{\text{MAX}}$, $T_A = +25^\circ\text{C}$	0.25	1.0		
$I_{\text{L(MIN)}}$	Minimum Load Current	$V_I - V_O = 35\text{ V}$		3.5	10	mA
V_{N}	RMS Noise, % of V_{OUT}	$10\text{ Hz} \leq f \leq 10\text{ kHz}$, $T_A = +25^\circ\text{C}$		0.003		%/ V_O
RR	Ripple Rejection	$V_O = 10\text{ V}$, $f = 120\text{ Hz}$, $C_{\text{ADJ}} = 0$		65		dB
		$V_O = 10\text{ V}$, $f = 120\text{ Hz}$, $C_{\text{ADJ}} = 10\text{ }\mu\text{F}$	66	80		
ST	Long-Term Stability	$T_J = +125^\circ\text{C}$		0.3	1	%/ 1000HR

Note:

- Regulation is measured at constant junction temperature. Changes in output voltage due to heating effects must be taken into account separately. Pulse testing with low duty cycle is used.

Typical Performance Characteristics

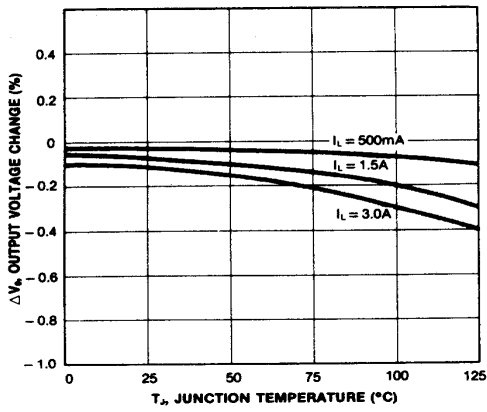

Figure 2. Load Regulation

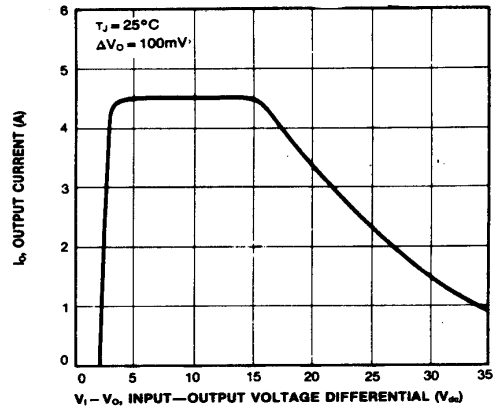

Figure 3. Current Limit

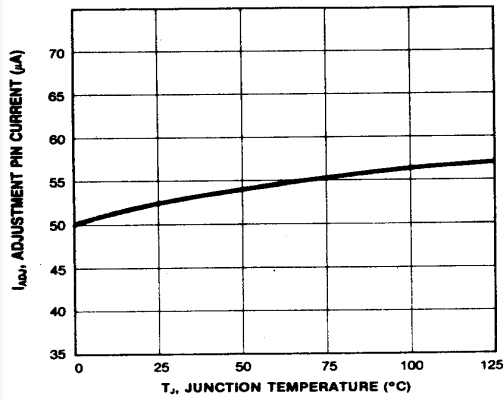

Figure 4. Adjustment Pin Current

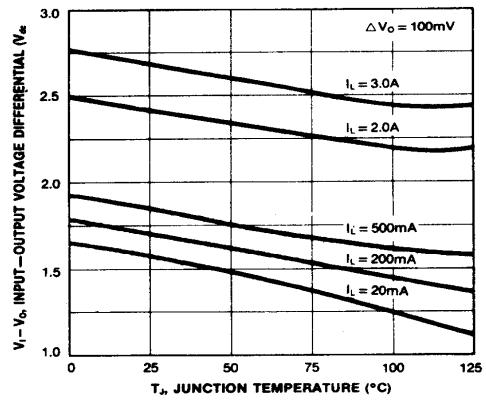

Figure 5. Dropout Voltage

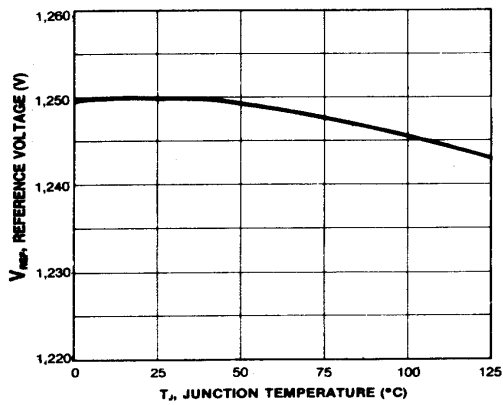

Figure 6. Temperature Stability

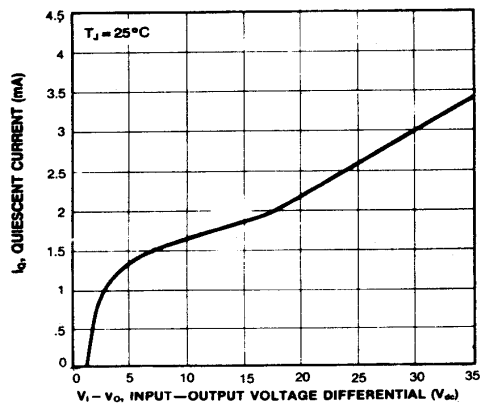

Figure 7. Minimum Load Current

Typical Performance Characteristics (Continued)

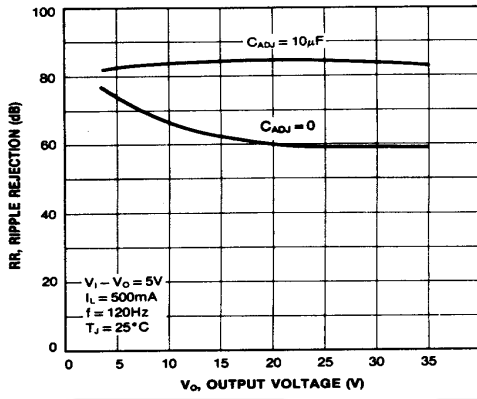

Figure 8. Ripple Rejection vs. V_O

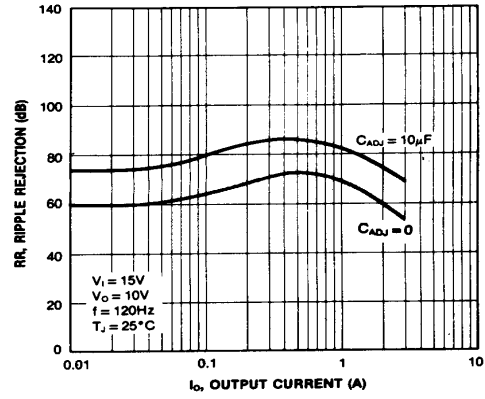

Figure 9. Ripple Rejection vs. I_O

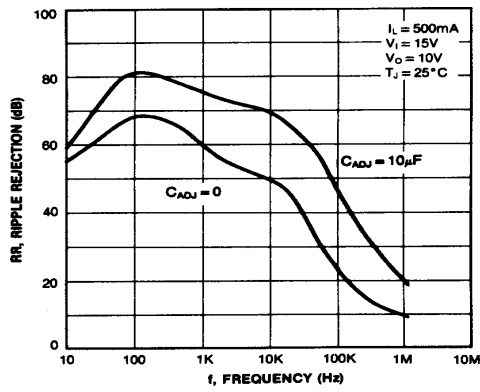

Figure 10. Ripple Rejection vs. Frequency

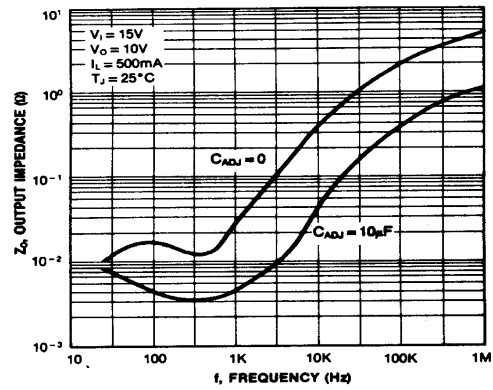

Figure 11. Output Impedance

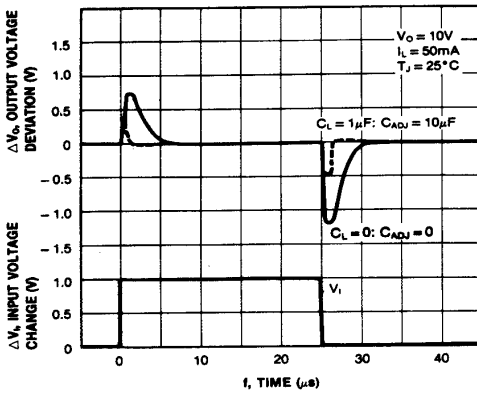

Figure 12. Line Transient Response

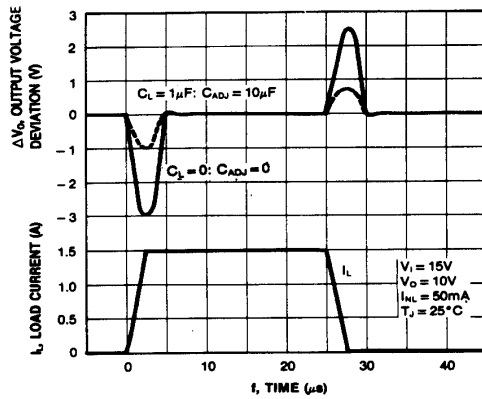

Figure 13. Load Transient Response

Typical Application⁽²⁾

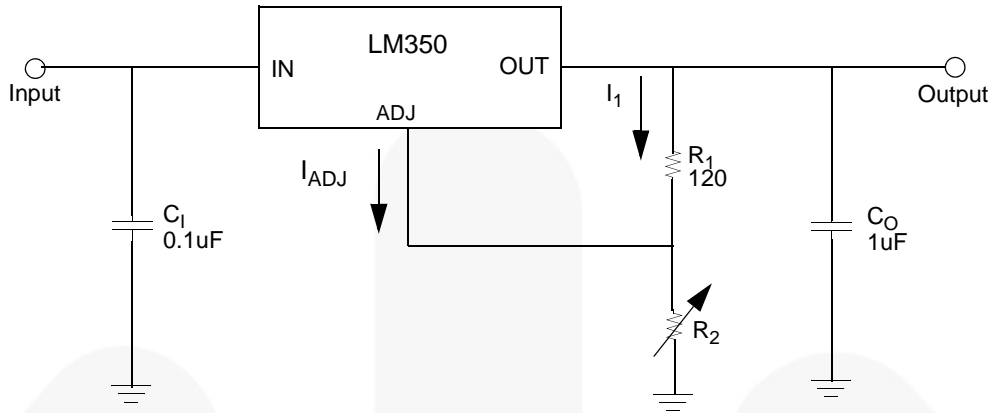

Figure 14.

Note:

2. C_1 : C_1 is required if the regulator is located an appreciable distance from power supply filter.
 C_0 : Output capacitors in the range of 1 μF to 100 μF of aluminum or tantalum electronic are commonly used to provide improved output impedance and rejection of transients.

In operation, the LM350 develops a nominal 1.25 V reference voltage, V_{REF} , between the output and adjustment terminal. The reference voltage is impressed across program resistor R_1 and, since the voltage is constant, a constant current I_1 then flows through the output set resistor R_2 , giving an output voltage of

$$V_O = 1.25 V(1+R_2/R_1) + I_{ADJ} R_2$$

Since I_{ADJ} current (less than 100 mA) from the adjustment terminal represents an error term, the LM350 was designed to minimize I_{ADJ} and make it very constant with line and load changes. To do this, all quiescent operating current is returned to the output establishing a minimum load current requirement. If there is insufficient load on the output, the output voltage will rise. Since the LM350 is a floating regulator, it is only the voltage differential across the circuit which is important to performance, and operation at high voltage with respect to ground is possible. Since I_{ADJ} is controlled to less than 100 mA, the error associated with this term is negligible in most applications.

Physical Dimensions

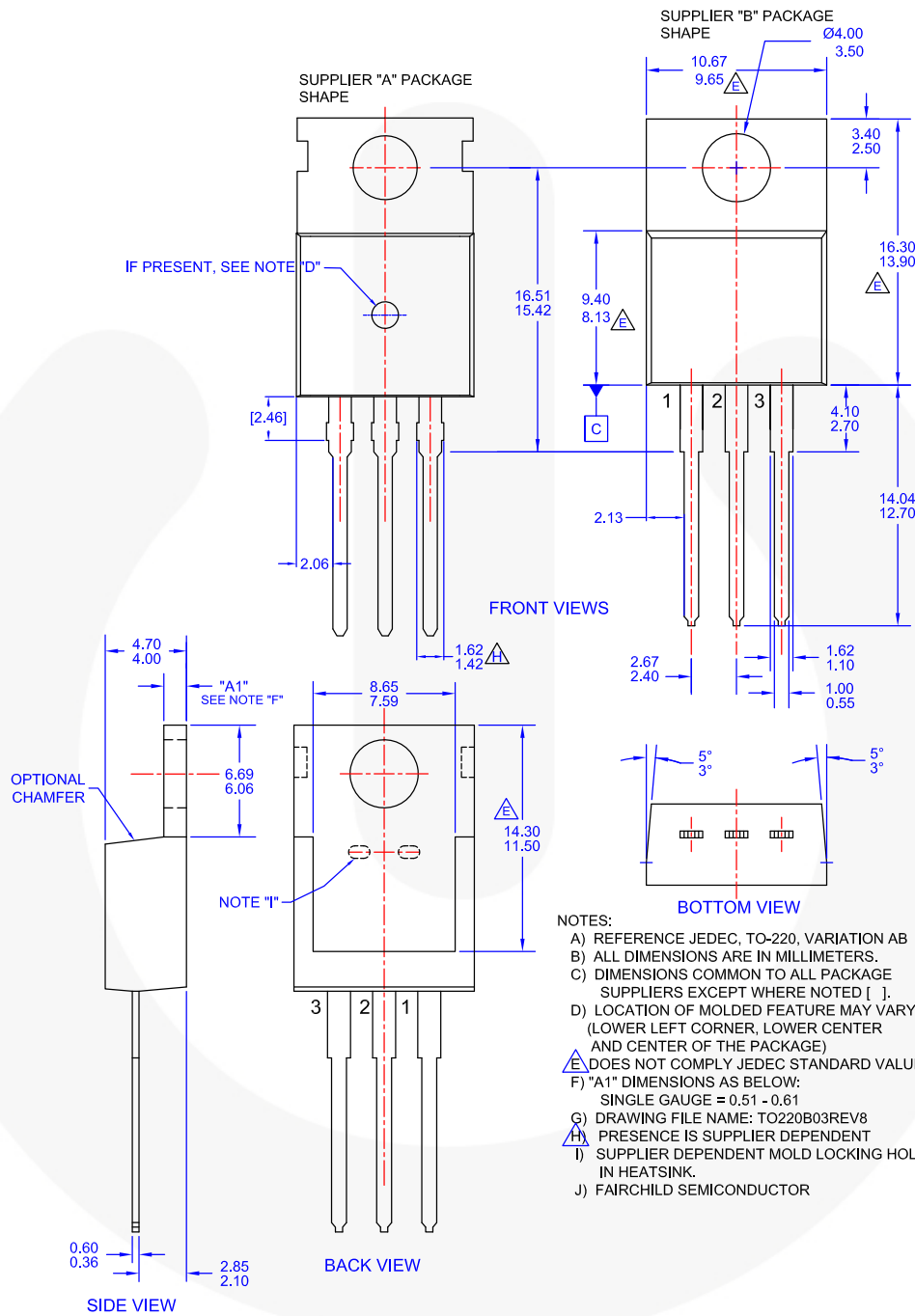

Figure 15. TO-220, MOLDED, 3LEAD, JEDEC VARIATION AB



TRADEMARKS

The following includes registered and unregistered trademarks and service marks, owned by Fairchild Semiconductor and/or its global subsidiaries, and is not intended to be an exhaustive list of all such trademarks.

- | | | | |
|--------------------------|--|---------------------------------------|------------------|
| AccuPower™ | F-PFS™ | | |
| Awinda® | FRFET® | PowerTrench® | TinyBoost® |
| AX-CAP®* | Global Power Resource SM | PowerXS™ | TinyBuck® |
| BitSiC™ | GreenBridge™ | Programmable Active Droop™ | TinyCalc™ |
| Build it Now™ | Green FPS™ | QFET® | TinyLogic® |
| CorePLUS™ | Green FPS™ e-Series™ | QS™ | TINYOPTO™ |
| CorePOWER™ | Gmax™ | Quiet Series™ | TinyPower™ |
| CROSSVOLT™ | GTO™ | RapidConfigure™ | TinyPWM™ |
| CTL™ | IntelliMAX™ | | TinyWire™ |
| Current Transfer Logic™ | ISOPLANAR™ | Saving our world, 1mW/W/kW at a time™ | TranSiC™ |
| DEUXPEED® | Making Small Speakers Sound Louder and Better™ | SignalWise™ | TriFault Detect™ |
| Dual Cool™ | MegaBuck™ | SmartMax™ | TRUECURRENT®* |
| EcoSPARK® | MICROCOUPLER™ | SMART START™ | µSerDes™ |
| EfficientMax™ | MicroFET™ | Solutions for Your Success™ | |
| ESBC™ | MicroPak™ | SPM® | UHC® |
| | MicroPak2™ | STEALTH™ | Ultra FRFET™ |
| Fairchild® | MillerDrive™ | SuperFET® | UniFET™ |
| Fairchild Semiconductor® | MotionMax™ | SuperSOT™-3 | VCX™ |
| FACT Quiet Series™ | MotionGrid® | SuperSOT™-6 | VisualMax™ |
| FACT® | MTI® | SuperSOT™-8 | VoltagePlus™ |
| FAST® | MTx® | SupreMOS® | XS™ |
| FastvCore™ | MVN® | SyncFET™ | Xsens™ |
| FETBench™ | mWSaver® | Sync-Lock™ | 仙童™ |
| FPS™ | OptoHiT™ | | |

* Trademarks of System General Corporation, used under license by Fairchild Semiconductor.

DISCLAIMER

FAIRCHILD SEMICONDUCTOR RESERVES THE RIGHT TO MAKE CHANGES WITHOUT FURTHER NOTICE TO ANY PRODUCTS HEREIN TO IMPROVE RELIABILITY, FUNCTION, OR DESIGN. TO OBTAIN THE LATEST, MOST UP-TO-DATE DATASHEET AND PRODUCT INFORMATION, VISIT OUR WEBSITE AT [HTTP://WWW.FAIRCHILDSEMI.COM](http://www.fairchildsemi.com). FAIRCHILD DOES NOT ASSUME ANY LIABILITY ARISING OUT OF THE APPLICATION OR USE OF ANY PRODUCT OR CIRCUIT DESCRIBED HEREIN; NEITHER DOES IT CONVEY ANY LICENSE UNDER ITS PATENT RIGHTS, NOR THE RIGHTS OF OTHERS. THESE SPECIFICATIONS DO NOT EXPAND THE TERMS OF FAIRCHILD'S WORLDWIDE TERMS AND CONDITIONS, SPECIFICALLY THE WARRANTY THEREIN, WHICH COVERS THESE PRODUCTS.

LIFE SUPPORT POLICY

FAIRCHILD'S PRODUCTS ARE NOT AUTHORIZED FOR USE AS CRITICAL COMPONENTS IN LIFE SUPPORT DEVICES OR SYSTEMS WITHOUT THE EXPRESS WRITTEN APPROVAL OF FAIRCHILD SEMICONDUCTOR CORPORATION.

As used herein:

1. Life support devices or systems are devices or systems which, (a) are intended for surgical implant into the body or (b) support or sustain life, and (c) whose failure to perform when properly used in accordance with instructions for use provided in the labeling, can be reasonably expected to result in a significant injury of the user.
2. A critical component in any component of a life support, device, or system whose failure to perform can be reasonably expected to cause the failure of the life support device or system, or to affect its safety or effectiveness.

ANTI-COUNTERFEITING POLICY

Fairchild Semiconductor Corporation's Anti-Counterfeiting Policy. Fairchild's Anti-Counterfeiting Policy is also stated on our external website, www.fairchildsemi.com, under Sales Support.

Counterfeiting of semiconductor parts is a growing problem in the industry. All manufacturers of semiconductor products are experiencing counterfeiting of their parts. Customers who inadvertently purchase counterfeit parts experience many problems such as loss of brand reputation, substandard performance, failed applications, and increased cost of production and manufacturing delays. Fairchild is taking strong measures to protect ourselves and our customers from the proliferation of counterfeit parts. Fairchild strongly encourages customers to purchase Fairchild parts either directly from Fairchild or from Authorized Fairchild Distributors who are listed by country on our web page cited above. Products customers buy either from Fairchild directly or from Authorized Fairchild Distributors are genuine parts, have full traceability, meet Fairchild's quality standards for handling and storage and provide access to Fairchild's full range of up-to-date technical and product information. Fairchild and our Authorized Distributors will stand behind all warranties and will appropriately address any warranty issues that may arise. Fairchild will not provide any warranty coverage or other assistance for parts bought from Unauthorized Sources. Fairchild is committed to combat this global problem and encourage our customers to do their part in stopping this practice by buying direct or from authorized distributors.

PRODUCT STATUS DEFINITIONS

Definition of Terms

Datasheet Identification	Product Status	Definition
Advance Information	Formative / In Design	Datasheet contains the design specifications for product development. Specifications may change in any manner without notice.
Preliminary	First Production	Datasheet contains preliminary data; supplementary data will be published at a later date. Fairchild Semiconductor reserves the right to make changes at any time without notice to improve design.
No Identification Needed	Full Production	Datasheet contains final specifications. Fairchild Semiconductor reserves the right to make changes at any time without notice to improve the design.
Obsolete	Not In Production	Datasheet contains specifications on a product that is discontinued by Fairchild Semiconductor. The datasheet is for reference information only.

ON Semiconductor and  are trademarks of Semiconductor Components Industries, LLC dba ON Semiconductor or its subsidiaries in the United States and/or other countries. ON Semiconductor owns the rights to a number of patents, trademarks, copyrights, trade secrets, and other intellectual property. A listing of ON Semiconductor's product/patent coverage may be accessed at www.onsemi.com/site/pdf/Patent-Marking.pdf. ON Semiconductor reserves the right to make changes without further notice to any products herein. ON Semiconductor makes no warranty, representation or guarantee regarding the suitability of its products for any particular purpose, nor does ON Semiconductor assume any liability arising out of the application or use of any product or circuit, and specifically disclaims any and all liability, including without limitation special, consequential or incidental damages. Buyer is responsible for its products and applications using ON Semiconductor products, including compliance with all laws, regulations and safety requirements or standards, regardless of any support or applications information provided by ON Semiconductor. "Typical" parameters which may be provided in ON Semiconductor data sheets and/or specifications can and do vary in different applications and actual performance may vary over time. All operating parameters, including "Typicals" must be validated for each customer application by customer's technical experts. ON Semiconductor does not convey any license under its patent rights nor the rights of others. ON Semiconductor products are not designed, intended, or authorized for use as a critical component in life support systems or any FDA Class 3 medical devices or medical devices with a same or similar classification in a foreign jurisdiction or any devices intended for implantation in the human body. Should Buyer purchase or use ON Semiconductor products for any such unintended or unauthorized application, Buyer shall indemnify and hold ON Semiconductor and its officers, employees, subsidiaries, affiliates, and distributors harmless against all claims, costs, damages, and expenses, and reasonable attorney fees arising out of, directly or indirectly, any claim of personal injury or death associated with such unintended or unauthorized use, even if such claim alleges that ON Semiconductor was negligent regarding the design or manufacture of the part. ON Semiconductor is an Equal Opportunity/Affirmative Action Employer. This literature is subject to all applicable copyright laws and is not for resale in any manner.

PUBLICATION ORDERING INFORMATION

LITERATURE FULFILLMENT:

Literature Distribution Center for ON Semiconductor
19521 E. 32nd Pkwy, Aurora, Colorado 80011 USA
Phone: 303-675-2175 or 800-344-3860 Toll Free USA/Canada
Fax: 303-675-2176 or 800-344-3867 Toll Free USA/Canada
Email: orderlit@onsemi.com

N. American Technical Support: 800-282-9855 Toll Free
USA/Canada
Europe, Middle East and Africa Technical Support:
Phone: 421 33 790 2910
Japan Customer Focus Center
Phone: 81-3-5817-1050

ON Semiconductor Website: www.onsemi.com
Order Literature: <http://www.onsemi.com/orderlit>
For additional information, please contact your local
Sales Representative