



Is Now Part of



ON Semiconductor®

To learn more about ON Semiconductor, please visit our website at
www.onsemi.com

ON Semiconductor and the ON Semiconductor logo are trademarks of Semiconductor Components Industries, LLC dba ON Semiconductor or its subsidiaries in the United States and/or other countries. ON Semiconductor owns the rights to a number of patents, trademarks, copyrights, trade secrets, and other intellectual property. A listing of ON Semiconductor's product/patent coverage may be accessed at www.onsemi.com/site/pdf/Patent-Marking.pdf. ON Semiconductor reserves the right to make changes without further notice to any products herein. ON Semiconductor makes no warranty, representation or guarantee regarding the suitability of its products for any particular purpose, nor does ON Semiconductor assume any liability arising out of the application or use of any product or circuit, and specifically disclaims any and all liability, including without limitation special, consequential or incidental damages. Buyer is responsible for its products and applications using ON Semiconductor products, including compliance with all laws, regulations and safety requirements or standards, regardless of any support or applications information provided by ON Semiconductor. "Typical" parameters which may be provided in ON Semiconductor data sheets and/or specifications can and do vary in different applications and actual performance may vary over time. All operating parameters, including "Typicals" must be validated for each customer application by customer's technical experts. ON Semiconductor does not convey any license under its patent rights nor the rights of others. ON Semiconductor products are not designed, intended, or authorized for use as a critical component in life support systems or any FDA Class 3 medical devices or medical devices with a same or similar classification in a foreign jurisdiction or any devices intended for implantation in the human body. Should Buyer purchase or use ON Semiconductor products for any such unintended or unauthorized application, Buyer shall indemnify and hold ON Semiconductor and its officers, employees, subsidiaries, affiliates, and distributors harmless against all claims, costs, damages, and expenses, and reasonable attorney fees arising out of, directly or indirectly, any claim of personal injury or death associated with such unintended or unauthorized use, even if such claim alleges that ON Semiconductor was negligent regarding the design or manufacture of the part. ON Semiconductor is an Equal Opportunity/Affirmative Action Employer. This literature is subject to all applicable copyright laws and is not for resale in any manner.



FDD8445 N-Channel PowerTrench[®] MOSFET

FDD8445

N-Channel PowerTrench[®] MOSFET 40V, 50A, 8.7mΩ

Features

- $R_{DS(ON)} = 6.7\text{ m}\Omega$ (Typ), $V_{GS} = 10\text{V}$, $I_D = 50\text{A}$
- $Q_{g(10)} = 45\text{nC}$ (Typ), $V_{GS} = 10\text{V}$
- Low Miller Charge
- Low Q_{rr} Body Diode
- UIS Capability (Single Pulse/ Repetitive Pulse)
- RoHS Compliant



Applications

- Powertrain Management
- Electronic Transmission
- Distributed Power Architecture and VRMs
- Primary Switch for 12V Systems

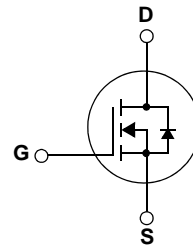
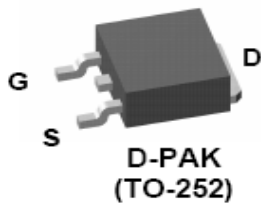

Absolute Maximum Ratings $T_c = 25^\circ\text{C}$ unless otherwise noted

Symbol	Parameter	Ratings	Units
V_{DSS}	Drain to Source Voltage	40	V
V_{GS}	Gate to Source Voltage	± 20	V
I_D	Drain Current Continuous ($V_{GS}=10\text{V}$) (Note 1)	70	A
	Continuous ($V_{GS}=10\text{V}$, with $R_{\theta JA} = 52^\circ\text{C/W}$)	15.2	A
	Pulsed	Figure 4	
E_{AS}	Single Pulse Avalanche Energy (Note 2)	144	mJ
P_D	Power Dissipation	79	W
	Derate above 25°C	0.53	W/ $^\circ\text{C}$
T_J, T_{STG}	Operating and Storage Temperature	-55 to +175	$^\circ\text{C}$

Thermal Characteristics

$R_{\theta JC}$	Thermal Resistance, Junction to Case	1.9	$^\circ\text{C/W}$
$R_{\theta JA}$	Thermal Resistance, Junction to Ambient TO-252AA, lin^2 copper pad area	52	$^\circ\text{C/W}$

Package Marking and Ordering Information

Device Marking	Device	Package	Reel Size	Tape Width	Quantity
FDD8445	FDD8445	TO-252AA	13"	16mm	2500 units

Electrical Characteristics $T_J = 25^\circ\text{C}$ unless otherwise noted

Symbol	Parameter	Test Conditions	Min	Typ	Max	Units
--------	-----------	-----------------	-----	-----	-----	-------

Off Characteristics

BV_{DSS}	Drain to Source Breakdown Voltage	$I_D = 250\mu\text{A}, V_{GS} = 0\text{V}$	40	-	-	V
I_{DSS}	Zero Gate Voltage Drain Current	$V_{DS} = 32\text{V}$ $V_{GS} = 0\text{V}$ $T_J = 150^\circ\text{C}$	-	-	1	μA
I_{GSS}	Gate to Source Leakage Current	$V_{GS} = \pm 20\text{V}$	-	-	± 100	nA

On Characteristics

$V_{GS(th)}$	Gate to Source Threshold Voltage	$V_{DS} = V_{GS}, I_D = 250\mu\text{A}$	2	2.8	4	V
$R_{DS(on)}$	Drain to Source On Resistance	$I_D = 50\text{A}, V_{GS} = 10\text{V}$	-	6.7	8.7	m Ω
		$I_D = 50\text{A}, V_{GS} = 10\text{V},$ $T_J = 175^\circ\text{C}$	-	12.5	16.3	

Dynamic Characteristics

C_{ISS}	Input Capacitance	$V_{DS} = 25\text{V}, V_{GS} = 0\text{V},$ $f = 1\text{MHz}$	-	3040	4050	pF	
C_{OSS}	Output Capacitance		-	295	390	pF	
C_{RSS}	Reverse Transfer Capacitance		-	178	270	pF	
R_G	Gate Resistance	$f = 1\text{MHz}$	-	1.7	-	Ω	
$Q_{g(TOT)}$	Total Gate Charge at 10V	$V_{GS} = 0$ to 10V	$V_{DD} = 20\text{V},$ $I_D = 50\text{A}$	-	45	59	nC
$Q_{g(5)}$	Total Gate Charge at 5V	$V_{GS} = 0$ to 5V		-	17	22	nC
$Q_{g(TH)}$	Threshold Gate Charge	$V_{GS} = 0$ to 2V		-	5.8	7.6	nC
Q_{gs}	Gate to Source Gate Charge			-	12.5	-	nC
Q_{gs2}	Gate Charge Threshold to Plateau			-	9.5	-	nC
Q_{gd}	Gate to Drain "Miller" Charge			-	10.5	-	nC

Electrical Characteristics $T_J = 25^\circ\text{C}$ unless otherwise noted

Symbol	Parameter	Test Conditions	Min	Typ	Max	Units
--------	-----------	-----------------	-----	-----	-----	-------

Switching Characteristics

Symbol	Parameter	Test Conditions	Min	Typ	Max	Units
$t_{(on)}$	Turn-On Time	$V_{DD} = 20\text{V}, I_D = 50\text{A}$ $V_{GS} = 10\text{V}, R_{GS} = 2\Omega$	-	-	138	ns
$t_{d(on)}$	Turn-On Delay Time		-	10	-	ns
t_r	Turn-On Rise Time		-	82	-	ns
$t_{d(off)}$	Turn-Off Delay Time		-	26	-	ns
t_f	Turn-Off Fall Time		-	9.6	-	ns
t_{off}	Turn-Off Time		-	-	53	ns

Drain-Source Diode Characteristics

Symbol	Parameter	Test Conditions	Min	Typ	Max	Units
V_{SD}	Source to Drain Diode Voltage	$I_{SD}=50\text{A}$	-	-	1.25	V
		$I_{SD}=25\text{A}$	-	-	1.0	V
t_{rr}	Reverse Recovery Time	$I_F = 50\text{A}, dI_F/dt = 100\text{A}/\mu\text{s}$	-	-	39	ns
Q_{rr}	Reverse Recovery Charge	$I_F = 50\text{A}, dI_F/dt = 100\text{A}/\mu\text{s}$	-	-	38	nC

Notes:

- 1: Maximum package current capability is 50A.
- 2: Starting $T_J = 25^\circ\text{C}$, $L=0.18\text{mH}$, $I_{AS}=40\text{A}$.

Typical Characteristics

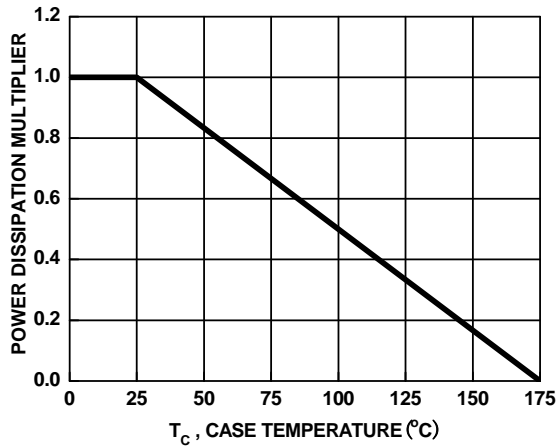

Figure 1. Normalized Power Dissipation vs Case Temperature

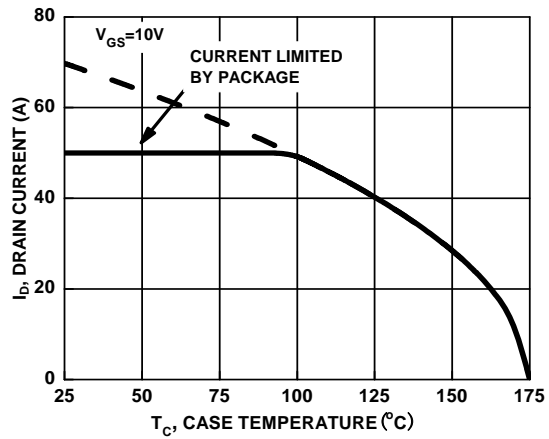

Figure 2. Maximum Continuous Drain Current vs Case Temperature

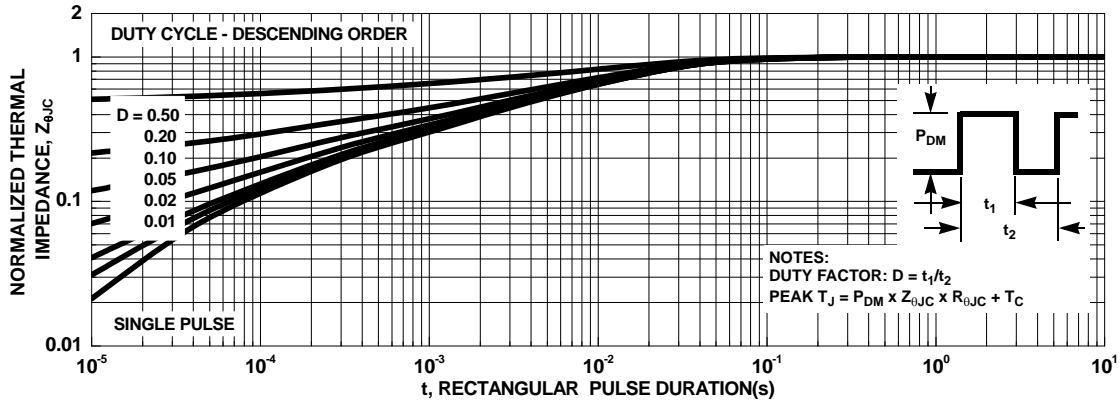

Figure 3. Normalized Maximum Transient Thermal Impedance

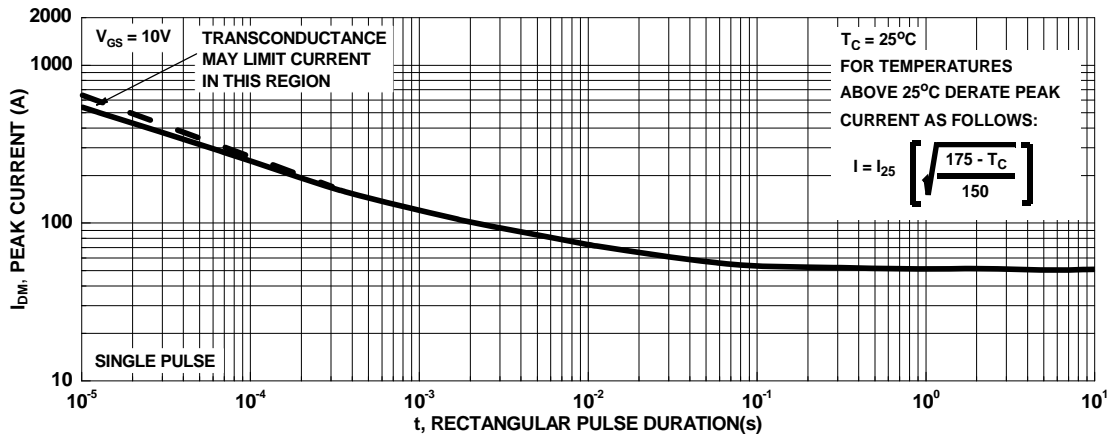

Figure 4. Peak Current Capability

Typical Characteristics

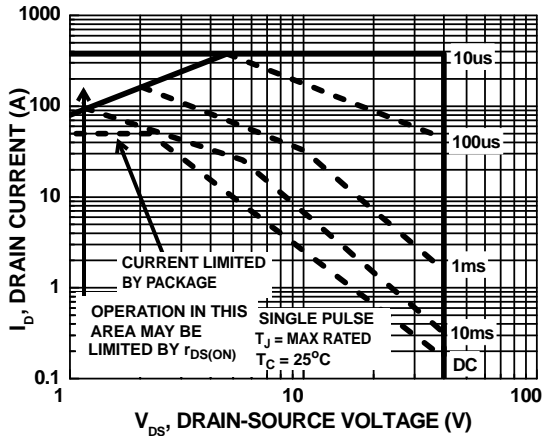
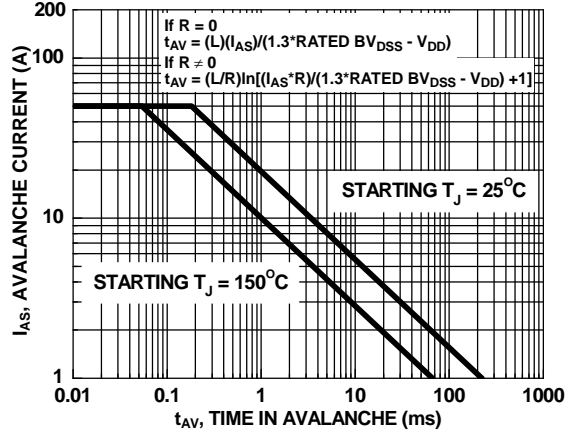

Figure 5. Forward Bias Safe Operating Area



NOTE: Refer to Fairchild Application Notes AN7514 and AN7515

Figure 6. Unclamped Inductive Switching Capability

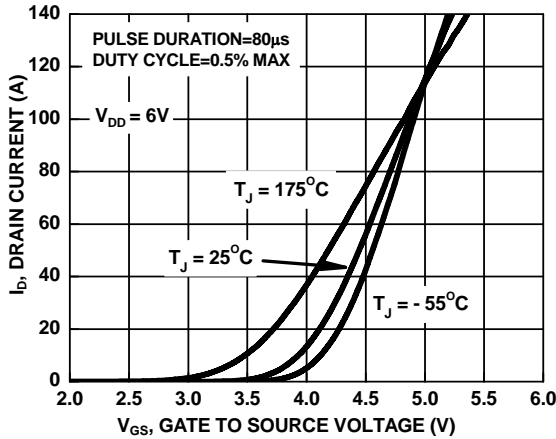

Figure 7. Transfer Characteristics

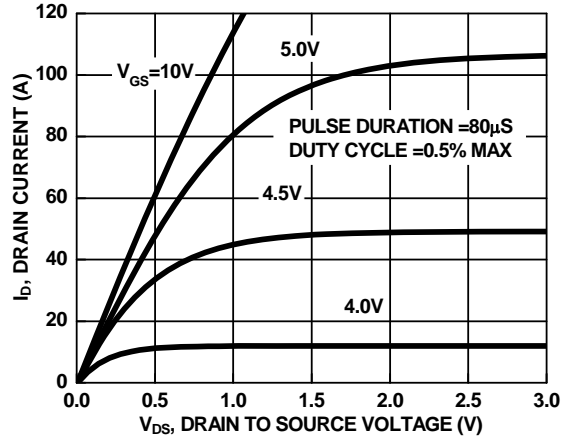

Figure 8. Saturation Characteristics

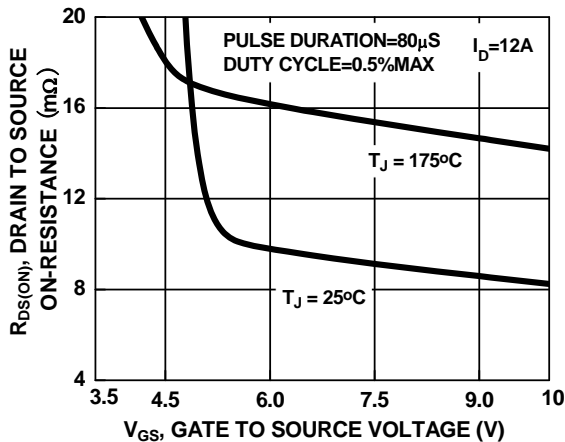

Figure 9. Drain to Source On-Resistance Variation vs Gate to Source Voltage

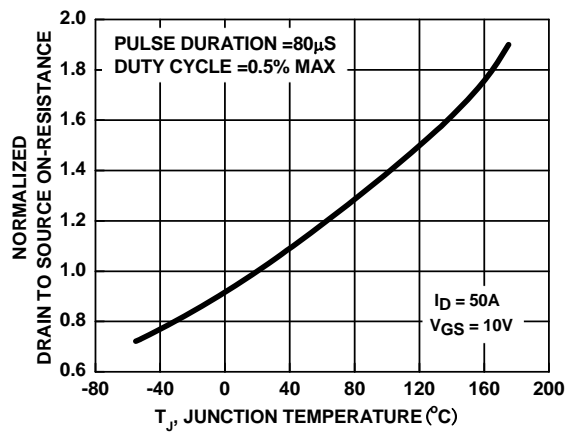

Figure 10. Normalized Drain to Source On-Resistance vs Junction Temperature

Typical Characteristics

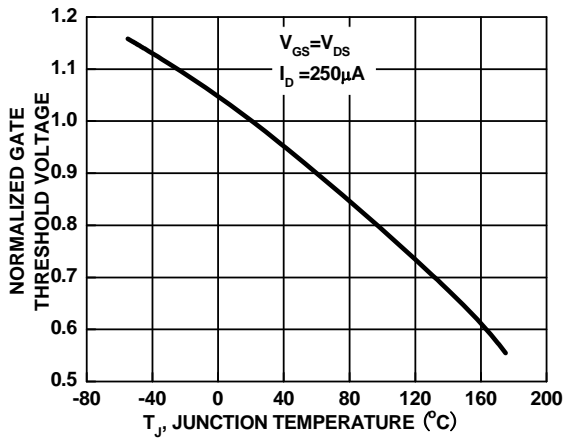

Figure 11. Normalized Gate Threshold Voltage vs Junction Temperature

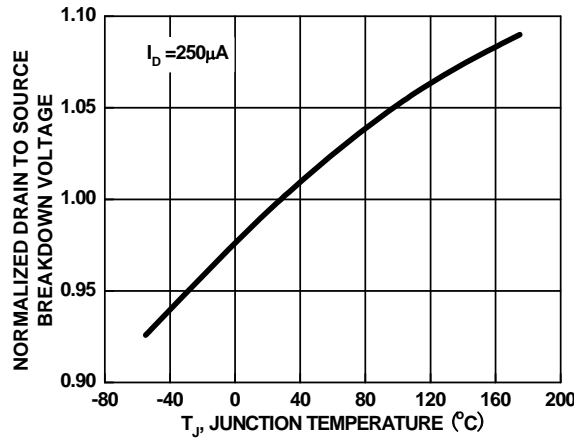

Figure 12. Normalized Drain to Source Breakdown Voltage vs Junction Temperature

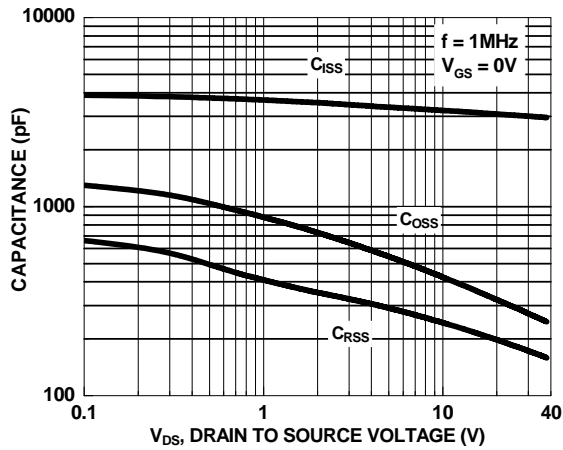

Figure 13. Capacitance vs Drain to Source Voltage

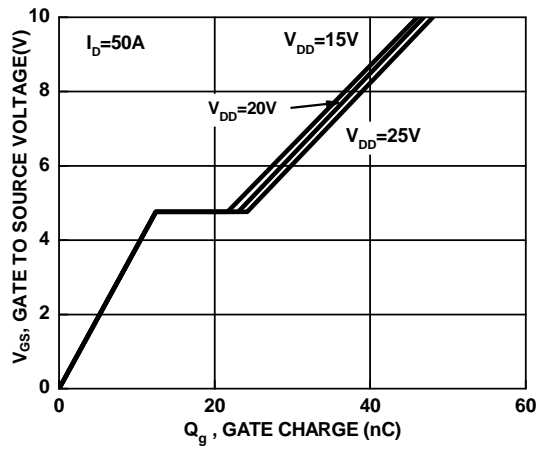
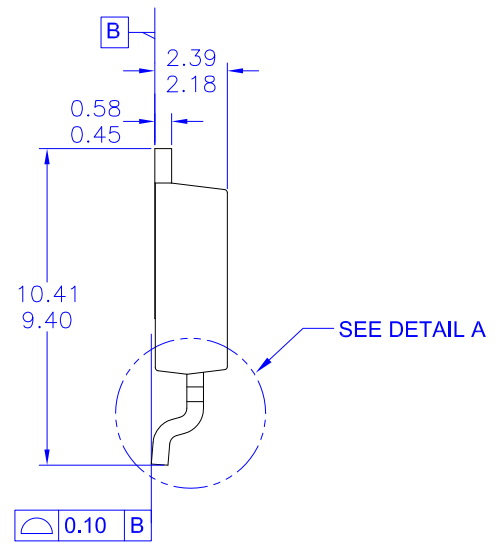
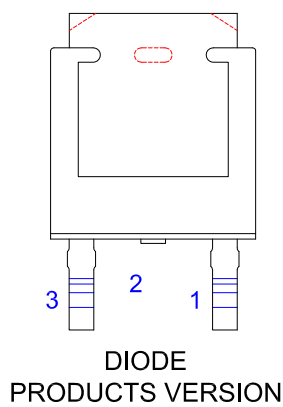

Figure 14. Gate Charge vs Gate to Source Voltage



NOTES: UNLESS OTHERWISE SPECIFIED
 A) THIS PACKAGE CONFORMS TO JEDEC, TO-252, ISSUE C, VARIATION AA.

B) ALL DIMENSIONS ARE IN MILLIMETERS.

C) DIMENSIONING AND TOLERANCING PER ASME Y14.5M-2009.

D) SUPPLIER DEPENDENT MOLD LOCKING HOLES OR CHAMFERED CORNERS OR EDGE PROTRUSION.

E) TRIMMED METAL CENTER LEAD IS PRESENT ON FOR NON-DIODE PRODUCTS

F) DIMENSIONS ARE EXCLUSIVE OF BURS, MOLD FLASH AND TIE BAR EXTRUSIONS.

G) LAND PATTERN RECOMMENDATION IS BASED ON IPC7351A STD TO228P991X239-3N.

H) DRAWING NUMBER AND REVISION: MKT-TO252A03REV11

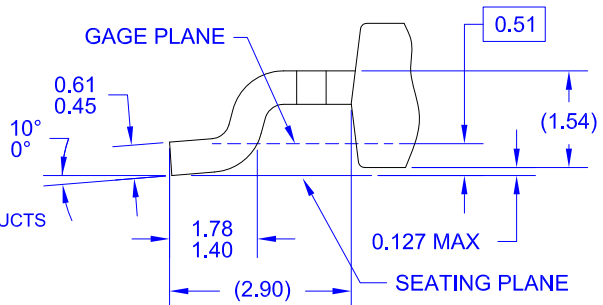

ON Semiconductor and  are trademarks of Semiconductor Components Industries, LLC dba ON Semiconductor or its subsidiaries in the United States and/or other countries. ON Semiconductor owns the rights to a number of patents, trademarks, copyrights, trade secrets, and other intellectual property. A listing of ON Semiconductor's product/patent coverage may be accessed at www.onsemi.com/site/pdf/Patent-Marking.pdf. ON Semiconductor reserves the right to make changes without further notice to any products herein. ON Semiconductor makes no warranty, representation or guarantee regarding the suitability of its products for any particular purpose, nor does ON Semiconductor assume any liability arising out of the application or use of any product or circuit, and specifically disclaims any and all liability, including without limitation special, consequential or incidental damages. Buyer is responsible for its products and applications using ON Semiconductor products, including compliance with all laws, regulations and safety requirements or standards, regardless of any support or applications information provided by ON Semiconductor. "Typical" parameters which may be provided in ON Semiconductor data sheets and/or specifications can and do vary in different applications and actual performance may vary over time. All operating parameters, including "Typicals" must be validated for each customer application by customer's technical experts. ON Semiconductor does not convey any license under its patent rights nor the rights of others. ON Semiconductor products are not designed, intended, or authorized for use as a critical component in life support systems or any FDA Class 3 medical devices or medical devices with a same or similar classification in a foreign jurisdiction or any devices intended for implantation in the human body. Should Buyer purchase or use ON Semiconductor products for any such unintended or unauthorized application, Buyer shall indemnify and hold ON Semiconductor and its officers, employees, subsidiaries, affiliates, and distributors harmless against all claims, costs, damages, and expenses, and reasonable attorney fees arising out of, directly or indirectly, any claim of personal injury or death associated with such unintended or unauthorized use, even if such claim alleges that ON Semiconductor was negligent regarding the design or manufacture of the part. ON Semiconductor is an Equal Opportunity/Affirmative Action Employer. This literature is subject to all applicable copyright laws and is not for resale in any manner.

PUBLICATION ORDERING INFORMATION

LITERATURE FULFILLMENT:

Literature Distribution Center for ON Semiconductor
19521 E. 32nd Pkwy, Aurora, Colorado 80011 USA
Phone: 303-675-2175 or 800-344-3860 Toll Free USA/Canada
Fax: 303-675-2176 or 800-344-3867 Toll Free USA/Canada
Email: orderlit@onsemi.com

N. American Technical Support: 800-282-9855 Toll Free
USA/Canada
Europe, Middle East and Africa Technical Support:
Phone: 421 33 790 2910
Japan Customer Focus Center
Phone: 81-3-5817-1050

ON Semiconductor Website: www.onsemi.com
Order Literature: <http://www.onsemi.com/orderlit>
For additional information, please contact your local
Sales Representative