



Is Now Part of



ON Semiconductor®

To learn more about ON Semiconductor, please visit our website at
www.onsemi.com

ON Semiconductor and the ON Semiconductor logo are trademarks of Semiconductor Components Industries, LLC dba ON Semiconductor or its subsidiaries in the United States and/or other countries. ON Semiconductor owns the rights to a number of patents, trademarks, copyrights, trade secrets, and other intellectual property. A listing of ON Semiconductor's product/patent coverage may be accessed at www.onsemi.com/site/pdf/Patent-Marking.pdf. ON Semiconductor reserves the right to make changes without further notice to any products herein. ON Semiconductor makes no warranty, representation or guarantee regarding the suitability of its products for any particular purpose, nor does ON Semiconductor assume any liability arising out of the application or use of any product or circuit, and specifically disclaims any and all liability, including without limitation special, consequential or incidental damages. Buyer is responsible for its products and applications using ON Semiconductor products, including compliance with all laws, regulations and safety requirements or standards, regardless of any support or applications information provided by ON Semiconductor. "Typical" parameters which may be provided in ON Semiconductor data sheets and/or specifications can and do vary in different applications and actual performance may vary over time. All operating parameters, including "Typicals" must be validated for each customer application by customer's technical experts. ON Semiconductor does not convey any license under its patent rights nor the rights of others. ON Semiconductor products are not designed, intended, or authorized for use as a critical component in life support systems or any FDA Class 3 medical devices or medical devices with a same or similar classification in a foreign jurisdiction or any devices intended for implantation in the human body. Should Buyer purchase or use ON Semiconductor products for any such unintended or unauthorized application, Buyer shall indemnify and hold ON Semiconductor and its officers, employees, subsidiaries, affiliates, and distributors harmless against all claims, costs, damages, and expenses, and reasonable attorney fees arising out of, directly or indirectly, any claim of personal injury or death associated with such unintended or unauthorized use, even if such claim alleges that ON Semiconductor was negligent regarding the design or manufacture of the part. ON Semiconductor is an Equal Opportunity/Affirmative Action Employer. This literature is subject to all applicable copyright laws and is not for resale in any manner.

NC7WZ08

TinyLogic® UHS Dual 2-Input AND Gate

Features

- Space saving US8 surface mount package
- MicroPak™ leadless package
- Ultra High Speed; t_{PD} 2.5ns Typ. into 50pF at 5V V_{CC}
- High Output Drive; $\pm 24mA$ at 3V V_{CC}
- Broad V_{CC} Operating Range; 1.65V to 5.5V
- Matches the performance of LCX when operated at 3.3V V_{CC}
- Power down high impedance inputs/output
- Overvoltage tolerant inputs facilitate 5V to 3V translation
- Patented noise/EMI reduction circuitry implemented

General Description

The NC7WZ08 is a dual 2-Input AND Gate from Fairchild's Ultra High Speed Series of TinyLogic®. The device is fabricated with advanced CMOS technology to achieve ultra high speed with high output drive while maintaining low static power dissipation over a very broad V_{CC} operating range. The device is specified to operate over the 1.65V to 5.5V V_{CC} range. The inputs and output are high impedance when V_{CC} is 0V. Inputs tolerate voltages up to 7V independent of V_{CC} operating voltage.

Ordering Information

Order Number	Package Number	Product Code Top Mark	Package Description	Supplied As
NC7WZ08K8X	MAB08A	WZ08	8-Lead US8, JEDEC MO-187, Variation CA 3.1mm Wide	3k Units on Tape and Reel
NC7WZ08L8X	MAC08A	X4	8-Lead MicroPak, 1.6 mm Wide	5k Units on Tape and Reel

Device also available in Tape and Reel. Specify by appending suffix letter "X" to the ordering number.

 All packages are lead free per JEDEC: J-STD-020B standard.

Connection Diagram

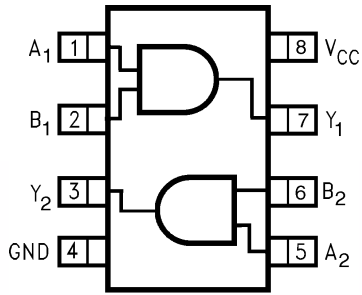

(Top View)

Pin One Orientation Diagram

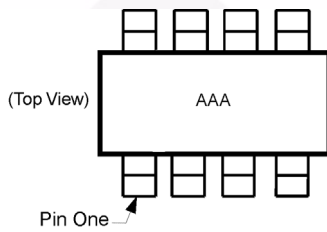

AAA represents Product Code Top Mark – see ordering code

Note: Orientation of Top Mark determines Pin One location. Read the top product code mark left to right, Pin One is the lower left pin (see diagram).

Pad Assignments for MicroPak

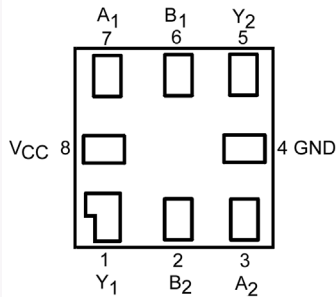

(Top Thru View)

Logic Symbol

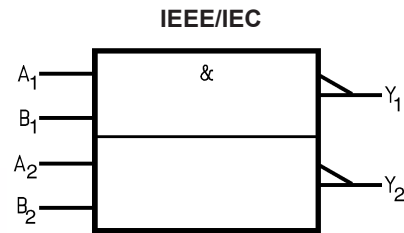

Function Table

$$Y = AB$$

Inputs		Output
A	B	Y
L	L	L
L	H	L
H	L	L
H	H	H

H = HIGH Logic Level

L = LOW Logic Level

Pin Description

Pin Names	Description
A_n, B_n	Inputs
Y_n	Output

Absolute Maximum Ratings

Stresses exceeding the absolute maximum ratings may damage the device. The device may not function or be operable above the recommended operating conditions and stressing the parts to these levels is not recommended. In addition, extended exposure to stresses above the recommended operating conditions may affect device reliability. The absolute maximum ratings are stress ratings only.

Symbol	Parameter	Rating
V_{CC}	Supply Voltage	-0.5V to +7V
V_{IN}	DC Input Voltage	-0.5V to +7V
V_{OUT}	DC Output Voltage	-0.5V to +7V
I_{IK}	DC Input Diode Current @ $V_{IN} < -0.5V$	-50mA
I_{OK}	DC Output Diode Current @ $V_{OUT} < -0.5V$	-50mA
I_{OUT}	DC Output Current	±50mA
I_{CC}/I_{GND}	DC V_{CC}/GND Current	±100mA
T_{STG}	Storage Temperature	-65°C to +150°C
T_J	Junction Temperature Under Bias	150°C
T_L	Junction Lead Temperature (Soldering, 10 seconds)	260°C
P_D	Power Dissipation @ +85°C US8 Micropak-8	245mW 165mW

Recommended Operating Conditions⁽¹⁾

The Recommended Operating Conditions table defines the conditions for actual device operation. Recommended operating conditions are specified to ensure optimal performance to the datasheet specifications. Fairchild does not recommend exceeding them or designing to absolute maximum ratings.

Symbol	Parameter	Rating
V_{CC}	Supply Voltage Operating	1.65V to 5.5V
	Supply Voltage Data Retention	1.5V to 5.5V
V_{IN}	Input Voltage	0V to 5.5V
V_{OUT}	Output Voltage	0V to V_{CC}
T_A	Operating Temperature	-40°C to +85°C
t_r, t_f	Input Rise and Fall Time $V_{CC} = 1.8V \pm 0.15V, 2.5V \pm 0.2V$	0ns/V to 20ns/V
	$V_{CC} = 3.3V \pm 0.3V$	0ns/V to 10ns/V
	$V_{CC} = 5.0V \pm 0.5V$	0ns/V to 5ns/V
θ_{JA}	Thermal Resistance US8	265°C/W
	Micropak-8	395°C/W

Note:

1. Unused inputs must be held HIGH or LOW. They may not float.

DC Electrical Characteristics

Symbol	Parameter	V _{CC} (V)	Conditions		T _A = 25°C			T _A = -40°C to +85°C		Units
					Min.	Typ.	Max.	Min.	Max.	
V _{IH}	HIGH Level Input Voltage	1.65–1.95			0.75 x V _{CC}			0.75 x V _{CC}		V
		2.3–5.5			0.7 x V _{CC}			0.7 x V _{CC}		
V _{IL}	LOW Level Input Voltage	1.65–1.95					0.25 x V _{CC}		0.25 x V _{CC}	V
		2.3–5.5					0.3 x V _{CC}		0.3 x V _{CC}	
V _{OH}	HIGH Level Output Voltage	1.65	V _{IN} = V _{IH}	I _{OH} = -100μA	1.55	1.65		1.55		V
		2.3			2.2	2.3		2.2		
		3.0			2.9	3.0		2.9		
		4.5			4.4	4.5		4.4		
		1.65		I _{OH} = -4mA	1.29	1.52		1.29		
		2.3			I _{OH} = -8mA	1.9	2.15		1.9	
		3.0			I _{OH} = -16mA	2.5	2.80		2.4	
		3.0			I _{OH} = -24mA	2.4	2.68		2.3	
		4.5			I _{OH} = -32mA	3.9	4.20		3.8	
V _{OL}	LOW Level Output Voltage	1.65	V _{IN} = V _{IL}	I _{OL} = 100μA		0.0	0.1		0.1	V
		2.3				0.0	0.1		0.1	
		3.0				0.0	0.1		0.1	
		4.5				0.0	0.1		0.1	
		1.65		I _{OL} = 4mA		0.08	0.24		0.24	
		2.3			I _{OL} = 8mA		0.10	0.3		0.3
		3.0			I _{OL} = 16mA		0.15	0.4		0.4
		3.0			I _{OL} = 24mA		0.22	0.55		0.55
		4.5			I _{OL} = 32mA		0.22	0.55		0.55
I _{IN}	Input Leakage Current	0–5.5	V _{IN} = 5.5V, GND				±0.1		±1	μA
I _{OFF}	Power Off Leakage Current	0.0	V _{IN} or V _{OUT} = 5.5V				1		10	μA
I _{CC}	Quiescent Supply Current	1.65–5.5	V _{IN} = 5.5V, GND				1		10	μA

AC Electrical Characteristics

Symbol	Parameter	V _{CC} (V)	Conditions	T _A = +25°C			T _A = -40°C to +85°C		Units	Figure Number
				Min	Typ	Max	Min	Max		
t _{PLH} , t _{PHL}	Propagation Delay	1.8 ± 0.15	C _L = 15pF, R _L = 1MΩ	2.0	5.7	10.5	2.0	11.0	ns	Figure 1 Figure 3
		2.5 ± 0.2		1.0	3.5	5.8	1.0	6.2		
		3.3 ± 0.3		0.8	2.6	3.9	0.8	4.3		
		5.0 ± 0.5		0.5	1.9	3.1	0.5	3.3		
t _{PLH} , t _{PHL}	Propagation Delay	3.3 ± 0.3	C _L = 50pF, R _L = 500Ω	1.2	3.2	4.8	1.2	5.2	ns	Figure 1 Figure 3
		5.0 ± 0.5		0.8	2.5	3.7	0.8	4.0		
C _{IN}	Input Capacitance	0			2.5				pF	
C _{PD}	Power Dissipation Capacitance	3.3	(2)		14.5				pF	Figure 2
		5.0			19.5					

Note:

2. C_{PD} is defined as the value of the internal equivalent capacitance which is derived from dynamic operating current consumption (I_{CCD}) at no output loading and operating at 50% duty cycle. (See Figure 2.) C_{PD} is related to I_{CCD} dynamic operating current by the expression: I_{CCD} = (C_{PD}) (V_{CC}) (f_{IN}) + (I_{CC} static)

AC Loading and Waveforms

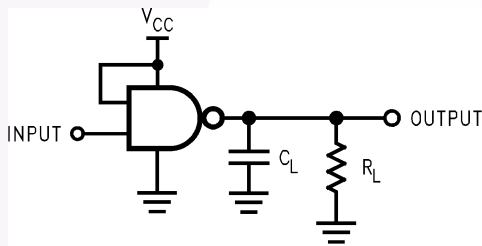

C_L includes load and stray capacitance
Input PRR = 1.0MHz, t_w = 500ns

Figure 1. AC Test Circuit

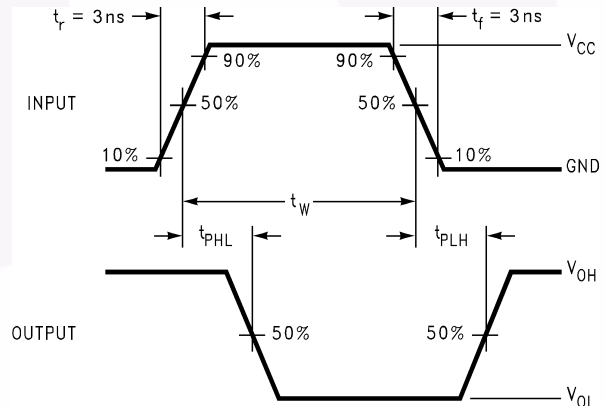
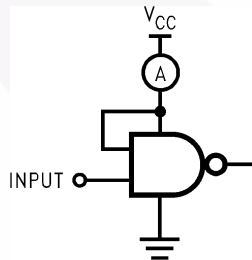

Figure 3. AC Waveforms



Input = Ac Waveform; t_r = t_f = 1.8ns;
PRR = 10 MHz; Duty Cycle = 50%

Figure 2. I_{CCD} Test Circuit

Tape and Reel Specifications (Continued)

Reel Dimensions inches (millimeters)

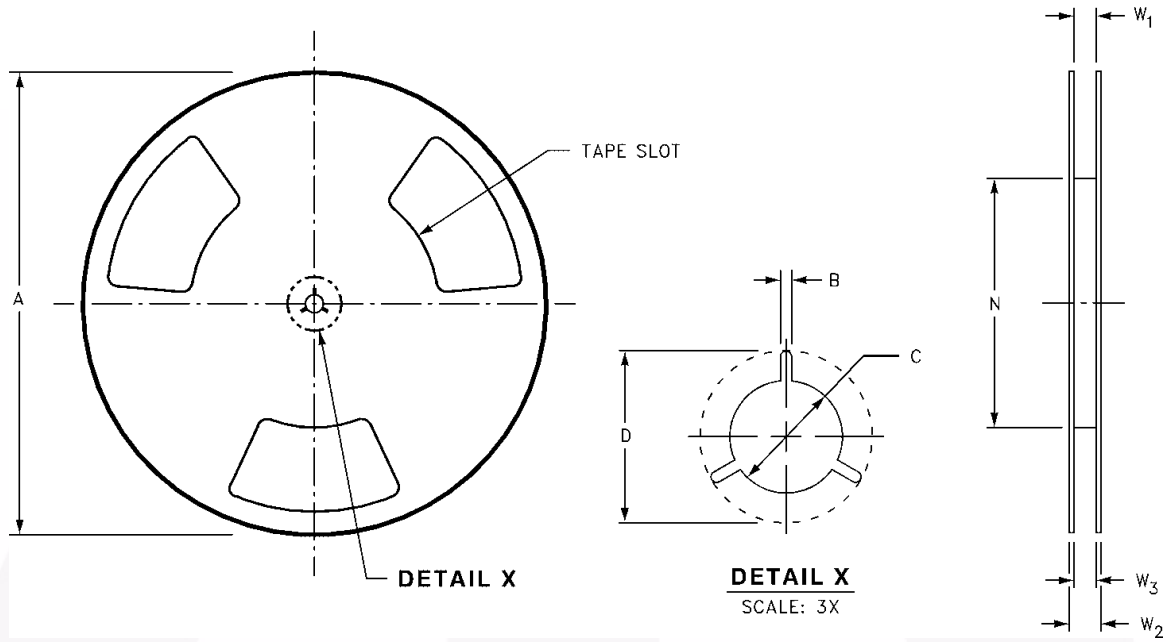

Tape Size	A	B	C	D	N	W1	W2	W3
8mm	7.0 (177.8)	0.059 (1.50)	0.512 (13.00)	0.795 (20.20)	2.165 (55.00)	0.331 +0.059/-0.000 (8.40 +1.50/-0.00)	0.567 (14.40)	W1 +0.078/-0.039 (W1 +2.00/-1.00)

Physical Dimensions

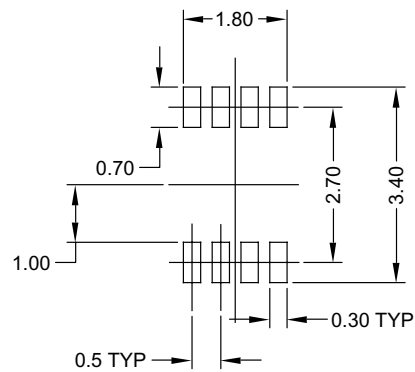
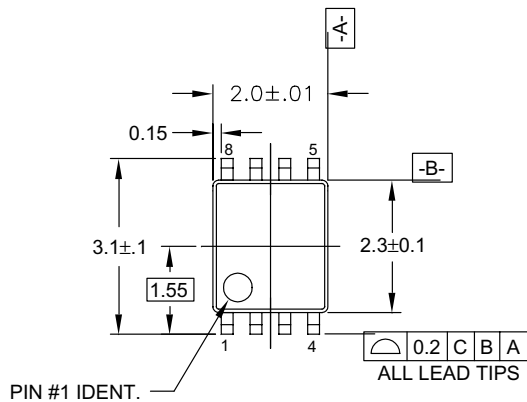

LAND PATTERN RECOMMENDATION

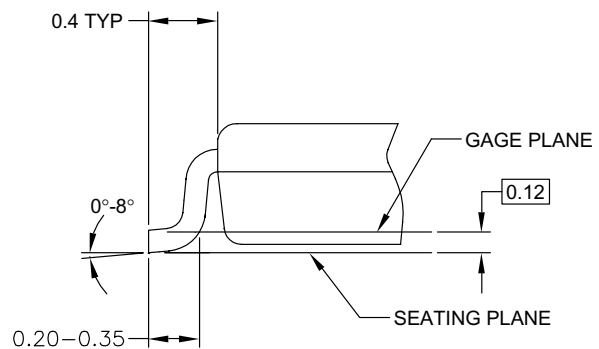
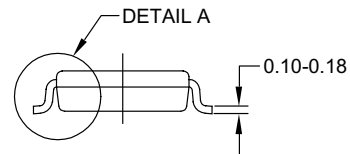
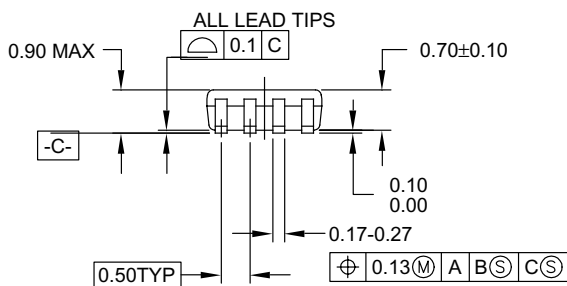

NOTES:

- A. CONFORMS TO JEDEC REGISTRATION MO-187
- B. DIMENSIONS ARE IN MILLIMETERS.
- C. DIMENSIONS ARE EXCLUSIVE OF BURRS, MOLD FLASH, AND TIE BAR EXTRUSIONS.
- D. DIMENSIONS AND TOLERANCES PER ANSI Y14.5M, 1982.

MAB08AREVC

Figure 4. 8-Lead US8, JEDEC MO-187, Variation CA 3.1mm Wide

Package drawings are provided as a service to customers considering Fairchild components. Drawings may change in any manner without notice. Please note the revision and/or date on the drawing and contact a Fairchild Semiconductor representative to verify or obtain the most recent revision. Package specifications do not expand the terms of Fairchild's worldwide terms and conditions, specifically the warranty therein, which covers Fairchild products.

Always visit Fairchild Semiconductor's online packaging area for the most recent package drawings:

<http://www.fairchildsemi.com/packaging/>

Physical Dimensions (Continued)

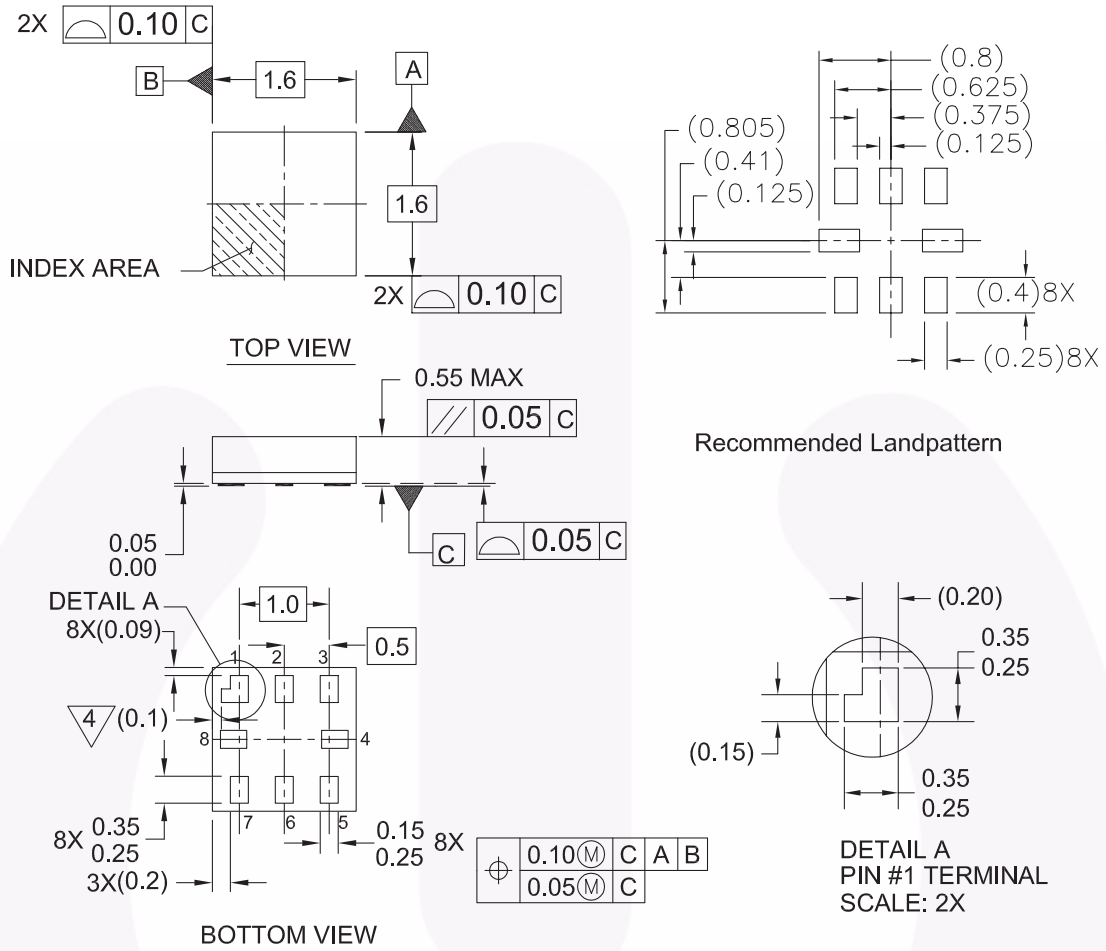

Notes:

1. PACKAGE CONFORMS TO JEDEC MO-255 VARIATION UAAD
2. DIMENSIONS ARE IN MILLIMETERS
3. DRAWING CONFORMS TO ASME Y.14M-1994
4. PIN 1 FLAG, END OF PACKAGE OFFSET
5. DRAWING FILE NAME: MKT-MAC08AREV4

MAC08AREV4

Figure 5. 8-Lead MicroPak, 1.6 mm Wide

Package drawings are provided as a service to customers considering Fairchild components. Drawings may change in any manner without notice. Please note the revision and/or date on the drawing and contact a Fairchild Semiconductor representative to verify or obtain the most recent revision. Package specifications do not expand the terms of Fairchild's worldwide terms and conditions, specifically the warranty therein, which covers Fairchild products.







Always visit Fairchild Semiconductor's online packaging area for the most recent package drawings:

<http://www.fairchildsemi.com/packaging/>



TRADEMARKS

The following includes registered and unregistered trademarks and service marks, owned by Fairchild Semiconductor and/or its global subsidiaries, and is not intended to be an exhaustive list of all such trademarks.

- | | | | |
|---|---|---|---|
| Build it Now™ | FRFET® | Programmable Active Droop™ | the power franchise |
| CorePLUS™ | Global Power Resource SM | QFET® | TinyBoost™ |
| CorePOWER™ | Green FPS™ | QS™ | TinyBuck™ |
| CROSSVOLT™ | Green FPS™ e-Series™ | Quiet Series™ | TinyLogic™ |
| CTL™ | GTO™ | RapidConfigure™ | TINYOPTO™ |
| Current Transfer Logic™ | IntelliMAX™ |  ™ | TinyPower™ |
| EcoSPARK® | ISOPLANAR™ | Saving our world, 1mW/W/kW at a time™ | TinyPWM™ |
| EfficientMax™ | MegaBuck™ | SmartMax™ | TinyWire™ |
| EZSWITCH™ * | MICROCOUPLER™ | SMART START™ | µSerDes™ |
|  ™ | MicroFET™ | SPM® |  ™ |
|  ™ | MicroPak™ | STEALTH™ | UHC® |
| Fairchild® | MillerDrive™ | SuperFET™ | Ultra FRFET™ |
| Fairchild Semiconductor® | MotionMax™ | SuperSOT™3 | UniFET™ |
| FACT Quiet Series™ | Motion-SPM™ | SuperSOT™6 | VCX™ |
| FACT® | OPTOLOGIC® | SuperSOT™8 | VisualMax™ |
| FAST® | OPTOPLANAR® | SupreMOS™ | XS™ |
| FastvCore™ |  ™ | SyncFET™ | |
| FlashWriter® * | PDP SPM™ |  ™ | |
| FPS™ | Power-SPM™ | The Power Franchise® | |
| F-PFS™ | PowerTrench® | | |
| | PowerXS™ | | |

* EZSWITCH™ and FlashWriter® are trademarks of System General Corporation, used under license by Fairchild Semiconductor.

DISCLAIMER

FAIRCHILD SEMICONDUCTOR RESERVES THE RIGHT TO MAKE CHANGES WITHOUT FURTHER NOTICE TO ANY PRODUCTS HEREIN TO IMPROVE RELIABILITY, FUNCTION, OR DESIGN. FAIRCHILD DOES NOT ASSUME ANY LIABILITY ARISING OUT OF THE APPLICATION OR USE OF ANY PRODUCT OR CIRCUIT DESCRIBED HEREIN; NEITHER DOES IT CONVEY ANY LICENSE UNDER ITS PATENT RIGHTS, NOR THE RIGHTS OF OTHERS. THESE SPECIFICATIONS DO NOT EXPAND THE TERMS OF FAIRCHILD'S WORLDWIDE TERMS AND CONDITIONS, SPECIFICALLY THE WARRANTY THEREIN, WHICH COVERS THESE PRODUCTS.

LIFE SUPPORT POLICY

FAIRCHILD'S PRODUCTS ARE NOT AUTHORIZED FOR USE AS CRITICAL COMPONENTS IN LIFE SUPPORT DEVICES OR SYSTEMS WITHOUT THE EXPRESS WRITTEN APPROVAL OF FAIRCHILD SEMICONDUCTOR CORPORATION.

As used herein:

- Life support devices or systems are devices or systems which, (a) are intended for surgical implant into the body or (b) support or sustain life, and (c) whose failure to perform when properly used in accordance with instructions for use provided in the labeling, can be reasonably expected to result in a significant injury of the user.
- A critical component in any component of a life support, device, or system whose failure to perform can be reasonably expected to cause the failure of the life support device or system, or to affect its safety or effectiveness.

ANTI-COUNTERFEITING POLICY

Fairchild Semiconductor Corporation's Anti-Counterfeiting Policy. Fairchild's Anti-Counterfeiting Policy is also stated on our external website, www.fairchildsemi.com, under Sales Support.

Counterfeiting of semiconductor parts is a growing problem in the industry. All manufacturers of semiconductor products are experiencing counterfeiting of their parts. Customers who inadvertently purchase counterfeit parts experience many problems such as loss of brand reputation, substandard performance, failed applications, and increased cost of production and manufacturing delays. Fairchild is taking strong measures to protect ourselves and our customers from the proliferation of counterfeit parts. Fairchild strongly encourages customers to purchase Fairchild parts either directly from Fairchild or from Authorized Fairchild Distributors who are listed by country on our web page cited above. Products customers buy either from Fairchild directly or from Authorized Fairchild Distributors are genuine parts, have full traceability, meet Fairchild's quality standards for handling and storage and provide access to Fairchild's full range of up-to-date technical and product information. Fairchild and our Authorized Distributors will stand behind all warranties and will appropriately address any warranty issues that may arise. Fairchild will not provide any warranty coverage or other assistance for parts bought from Unauthorized Sources. Fairchild is committed to combat this global problem and encourage our customers to do their part in stopping this practice by buying direct or from authorized distributors.

PRODUCT STATUS DEFINITIONS

Definition of Terms

Datasheet Identification	Product Status	Definition
Advance Information	Formative / In Design	Datasheet contains the design specifications for product development. Specifications may change in any manner without notice.
Preliminary	First Production	Datasheet contains preliminary data; supplementary data will be published at a later date. Fairchild Semiconductor reserves the right to make changes at any time without notice to improve design.
No Identification Needed	Full Production	Datasheet contains final specifications. Fairchild Semiconductor reserves the right to make changes at any time without notice to improve the design.
Obsolete	Not In Production	Datasheet contains specifications on a product that is discontinued by Fairchild Semiconductor. The datasheet is for reference information only.

Rev. 137

ON Semiconductor and  are trademarks of Semiconductor Components Industries, LLC dba ON Semiconductor or its subsidiaries in the United States and/or other countries. ON Semiconductor owns the rights to a number of patents, trademarks, copyrights, trade secrets, and other intellectual property. A listing of ON Semiconductor's product/patent coverage may be accessed at www.onsemi.com/site/pdf/Patent-Marking.pdf. ON Semiconductor reserves the right to make changes without further notice to any products herein. ON Semiconductor makes no warranty, representation or guarantee regarding the suitability of its products for any particular purpose, nor does ON Semiconductor assume any liability arising out of the application or use of any product or circuit, and specifically disclaims any and all liability, including without limitation special, consequential or incidental damages. Buyer is responsible for its products and applications using ON Semiconductor products, including compliance with all laws, regulations and safety requirements or standards, regardless of any support or applications information provided by ON Semiconductor. "Typical" parameters which may be provided in ON Semiconductor data sheets and/or specifications can and do vary in different applications and actual performance may vary over time. All operating parameters, including "Typicals" must be validated for each customer application by customer's technical experts. ON Semiconductor does not convey any license under its patent rights nor the rights of others. ON Semiconductor products are not designed, intended, or authorized for use as a critical component in life support systems or any FDA Class 3 medical devices or medical devices with a same or similar classification in a foreign jurisdiction or any devices intended for implantation in the human body. Should Buyer purchase or use ON Semiconductor products for any such unintended or unauthorized application, Buyer shall indemnify and hold ON Semiconductor and its officers, employees, subsidiaries, affiliates, and distributors harmless against all claims, costs, damages, and expenses, and reasonable attorney fees arising out of, directly or indirectly, any claim of personal injury or death associated with such unintended or unauthorized use, even if such claim alleges that ON Semiconductor was negligent regarding the design or manufacture of the part. ON Semiconductor is an Equal Opportunity/Affirmative Action Employer. This literature is subject to all applicable copyright laws and is not for resale in any manner.

PUBLICATION ORDERING INFORMATION

LITERATURE FULFILLMENT:

Literature Distribution Center for ON Semiconductor
19521 E. 32nd Pkwy, Aurora, Colorado 80011 USA
Phone: 303-675-2175 or 800-344-3860 Toll Free USA/Canada
Fax: 303-675-2176 or 800-344-3867 Toll Free USA/Canada
Email: orderlit@onsemi.com

N. American Technical Support: 800-282-9855 Toll Free
USA/Canada
Europe, Middle East and Africa Technical Support:
Phone: 421 33 790 2910
Japan Customer Focus Center
Phone: 81-3-5817-1050

ON Semiconductor Website: www.onsemi.com
Order Literature: <http://www.onsemi.com/orderlit>
For additional information, please contact your local
Sales Representative