



Is Now Part of



**ON Semiconductor®**

To learn more about ON Semiconductor, please visit our website at  
[www.onsemi.com](http://www.onsemi.com)

ON Semiconductor and the ON Semiconductor logo are trademarks of Semiconductor Components Industries, LLC dba ON Semiconductor or its subsidiaries in the United States and/or other countries. ON Semiconductor owns the rights to a number of patents, trademarks, copyrights, trade secrets, and other intellectual property. A listing of ON Semiconductor's product/patent coverage may be accessed at [www.onsemi.com/site/pdf/Patent-Marking.pdf](http://www.onsemi.com/site/pdf/Patent-Marking.pdf). ON Semiconductor reserves the right to make changes without further notice to any products herein. ON Semiconductor makes no warranty, representation or guarantee regarding the suitability of its products for any particular purpose, nor does ON Semiconductor assume any liability arising out of the application or use of any product or circuit, and specifically disclaims any and all liability, including without limitation special, consequential or incidental damages. Buyer is responsible for its products and applications using ON Semiconductor products, including compliance with all laws, regulations and safety requirements or standards, regardless of any support or applications information provided by ON Semiconductor. "Typical" parameters which may be provided in ON Semiconductor data sheets and/or specifications can and do vary in different applications and actual performance may vary over time. All operating parameters, including "Typicals" must be validated for each customer application by customer's technical experts. ON Semiconductor does not convey any license under its patent rights nor the rights of others. ON Semiconductor products are not designed, intended, or authorized for use as a critical component in life support systems or any FDA Class 3 medical devices or medical devices with a same or similar classification in a foreign jurisdiction or any devices intended for implantation in the human body. Should Buyer purchase or use ON Semiconductor products for any such unintended or unauthorized application, Buyer shall indemnify and hold ON Semiconductor and its officers, employees, subsidiaries, affiliates, and distributors harmless against all claims, costs, damages, and expenses, and reasonable attorney fees arising out of, directly or indirectly, any claim of personal injury or death associated with such unintended or unauthorized use, even if such claim alleges that ON Semiconductor was negligent regarding the design or manufacture of the part. ON Semiconductor is an Equal Opportunity/Affirmative Action Employer. This literature is subject to all applicable copyright laws and is not for resale in any manner.

# FFB3904 / FMB3904 / MMPQ3904 NPN Multi-Chip General Purpose Amplifier

## Description

This device is designed as a general-purpose amplifier and switch. The useful dynamic range extends to 100 mA as a switch and to 100 MHz as an amplifier. Sourced from Process 23.

## Block Diagram

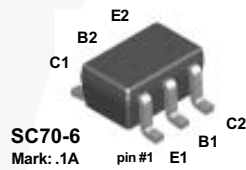

Figure 1. FFB3904 Device Package

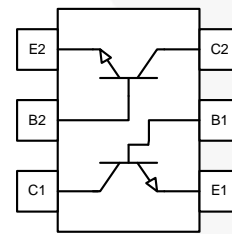

Figure 2. FFB3904 Internal Connection

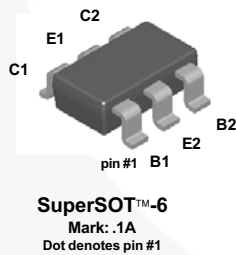

Figure 3. FMB3904 Device Package

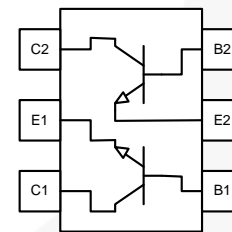

Figure 4. FMB3904 Internal Connection

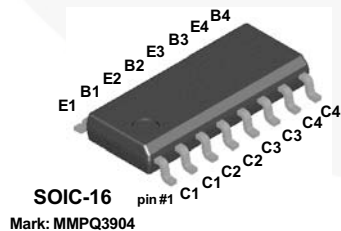

Figure 5. MMPQ3904 Device Package

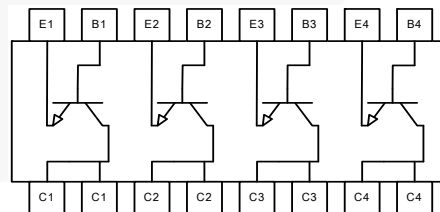

Figure 6. MMPQ3904 Internal Connection

## Ordering Information

Part Number	Top Mark	Package	Packing Method
FFB3904	.1A	SC70 6L	Tape and Reel
FMB3904	.1A	SSOT 6L	Tape and Reel
MMPQ3904	MMPQ3904	SOIC 16L	Tape and Reel

## Absolute Maximum Ratings<sup>(1)</sup>

Stresses exceeding the absolute maximum ratings may damage the device. The device may not function or be operable above the recommended operating conditions and stressing the parts to these levels is not recommended. In addition, extended exposure to stresses above the recommended operating conditions may affect device reliability. The absolute maximum ratings are stress ratings only. Values are at  $T_A = 25^\circ\text{C}$  unless otherwise noted.

Symbol	Parameter	Value	Unit
$V_{CEO}$	Collector-Emitter Voltage	40	V
$V_{CBO}$	Collector-Base Voltage	60	V
$V_{EBO}$	Emitter-Base Voltage	6.0	V
$I_C$	Collector Current - Continuous	200	mA
$T_J, T_{STG}$	Operating and Storage Junction Temperature Range	-55 to +150	$^\circ\text{C}$

### Note:

1. These ratings are based on a maximum junction temperature of  $150^\circ\text{C}$ . These are steady-state limits. Fairchild Semiconductor should be consulted on applications involving pulsed or low-duty cycle operations.

## Thermal Characteristics<sup>(2)</sup>

Values are at  $T_A = 25^\circ\text{C}$  unless otherwise noted.

Symbol	Parameter	Max.			Unit
		FFB3904	FMB3904	MMPQ3904	
$P_D$	Total Device Dissipation	300	700	1,000	mW
	Derate above $25^\circ\text{C}$	2.4	5.6	8.0	mW/ $^\circ\text{C}$
$R_{\theta JA}$	Thermal Resistance, Junction to Ambient	415	180		$^\circ\text{C}/\text{W}$
	Thermal Resistance, Junction to Ambient, Effective 4 Die			125	
	Thermal Resistance, Junction to Ambient, Each Die			240	

### Note:

2. PCB size: FR-4 76 x 114 x 0.6T mm<sup>3</sup> (3.0 inch x 4.5 inch x 0.062 inch) with minimum land pattern size.

## Electrical Characteristics

Values are at  $T_A = 25^\circ\text{C}$  unless otherwise noted.

Symbol	Parameter	Conditions	Min.	Typ.	Max.	Unit
<b>Off Characteristics</b>						
$V_{(BR)CEO}$	Collector-Emitter Breakdown Voltage	$I_C = 1.0\text{ mA}, I_B = 0$	40			V
$V_{(BR)CBO}$	Collector-Base Breakdown Voltage	$I_C = 10\text{ }\mu\text{A}, I_E = 0$	60			V
$V_{(BR)EBO}$	Emitter-Base Breakdown Voltage	$I_E = 10\text{ }\mu\text{A}, I_C = 0$	6.0			V
$I_{BL}$	Base Cut-Off Current	$V_{CE} = 30\text{ V}, V_{BE} = -3\text{ V}$			50	nA
$I_{CEX}$	Collector Cut-Off Current	$V_{CE} = 30\text{ V}, V_{BE} = -3\text{ V}$			50	nA
<b>On Characteristics<sup>(3)</sup></b>						
$h_{FE}$	DC Current Gain	FFB3904, FMB3904	$I_C = 0.1\text{ mA}, V_{CE} = 1.0\text{ V}$	40		
		MMPQ3904		30		
		FFB3904, FMB3904	$I_C = 1.0\text{ mA}, V_{CE} = 1.0\text{ V}$	70		
		MMPQ3904		50		
		FFB3904, FMB3904	$I_C = 10\text{ mA}, V_{CE} = 1.0\text{ V}$	100		300
		MMPQ3904		75		
		All Devices	$I_C = 50\text{ mA}, V_{CE} = 1.0\text{ V}$	60		
		All Devices	$I_C = 100\text{ mA}, V_{CE} = 1.0\text{ V}$	30		
$V_{CE(sat)}$	Collector-Emitter Saturation Voltage	$I_C = 10\text{ mA}, I_B = 1.0\text{ mA}$			0.2	V
		$I_C = 50\text{ mA}, I_B = 5.0\text{ mA}$			0.3	
$V_{BE(sat)}$	Base-Emitter Saturation Voltage	$I_C = 10\text{ mA}, I_B = 1.0\text{ mA}$	0.65		0.85	V
		$I_C = 50\text{ mA}, I_B = 5.0\text{ mA}$			0.95	
<b>Small-Signal Characteristics (MMPQ3904 only)</b>						
$f_T$	Current Gain-Bandwidth Product	$I_C = 10\text{ mA}, V_{CE} = 20\text{ V},$ $f = 100\text{ MHz}$		250		MHz
$C_{ob}$	Output Capacitance	$V_{CB} = 5.0\text{ V}, I_E = 0,$ $f = 140\text{ kHz}$		4.0		pF
$C_{ib}$	Input Capacitance	$V_{BE} = 0.5\text{ V}, I_C = 0,$ $f = 140\text{ kHz}$		8.0		pF

**Note:**

3. Pulse test: pulse width  $\leq 300\text{ }\mu\text{s}$ , duty cycle  $\leq 2.0\%$ .

## Typical Performance Characteristics

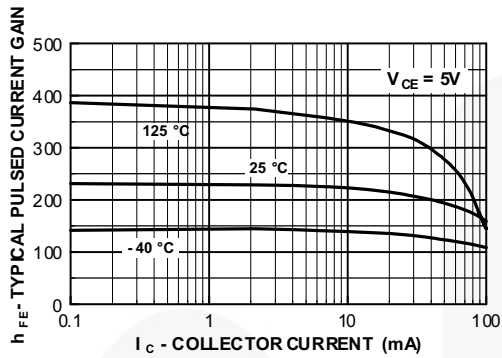

Figure 7. Typical Pulsed Current Gain vs. Collector Current

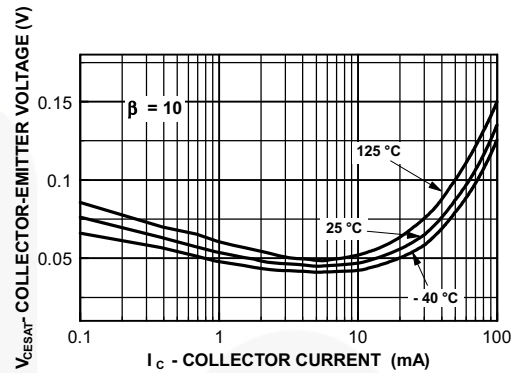

Figure 8. Collector-Emitter Saturation Voltage vs. Collector Current

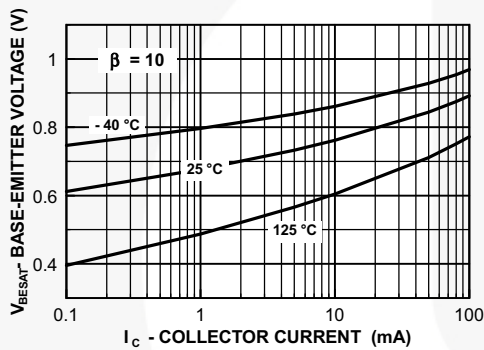

Figure 9. Base-Emitter Saturation Voltage vs. Collector Current

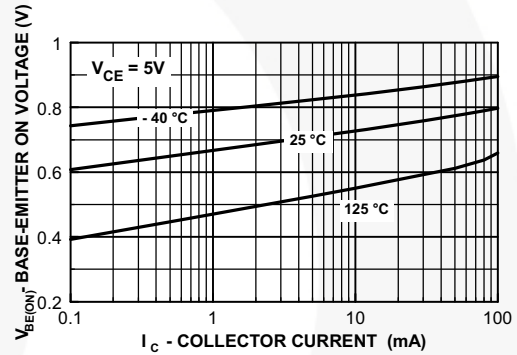

Figure 10. Base-Emitter On Voltage vs. Collector Current

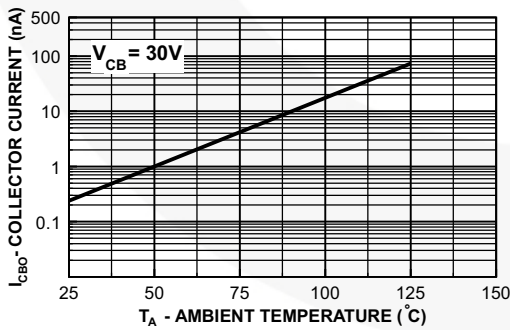

Figure 11. Collector Cut-Off Current vs. Ambient Temperature

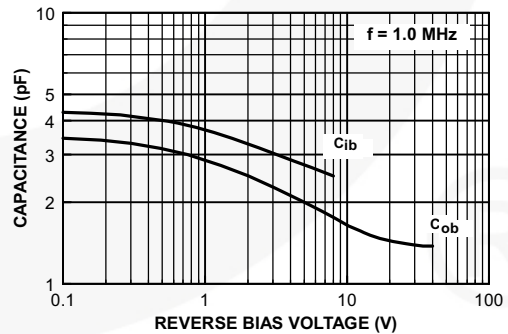
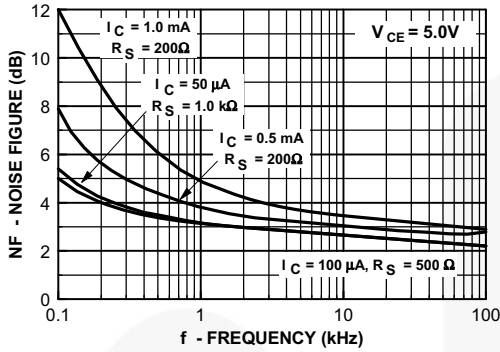
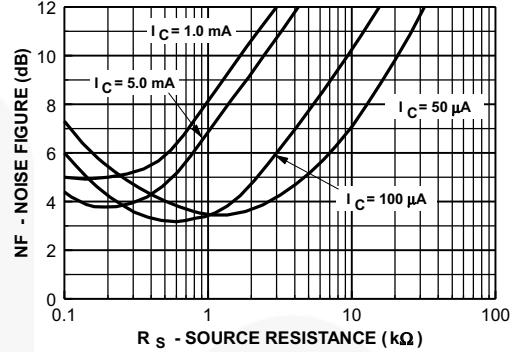

Figure 12. Capacitance vs. Reverse Bias Voltage

**Typical Performance Characteristics (Continued)**



**Figure 13. Noise Figure vs. Frequency**



**Figure 14. Noise Figure vs. Source Resistance**

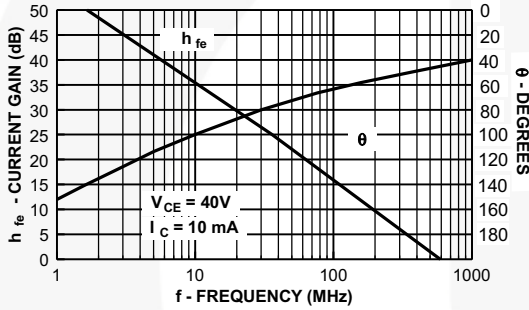

**Figure 15. Current Gain and Phase Angle vs. Frequency**

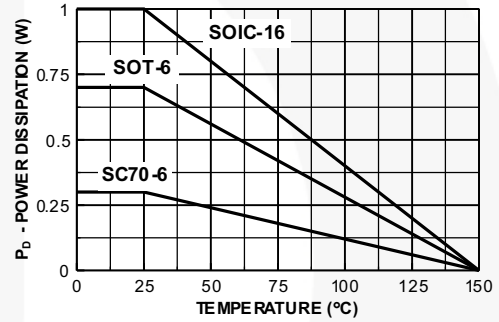

**Figure 16. Power Dissipation vs. Ambient Temperature**

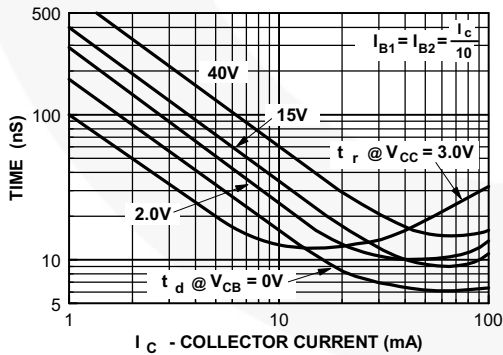

**Figure 17. Turn-On Time vs. Collector Current**

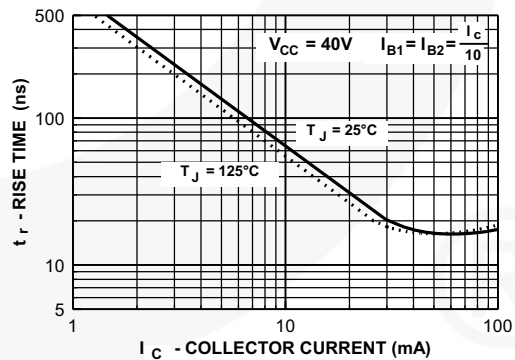

**Figure 18. Rise Time vs. Collector Current**

Typical Performance Characteristics (Continued)

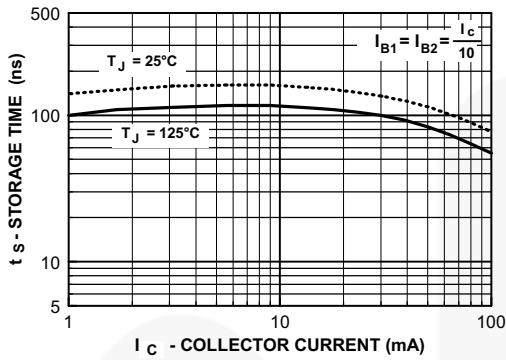

Figure 19. Storage Time vs. Collector Current

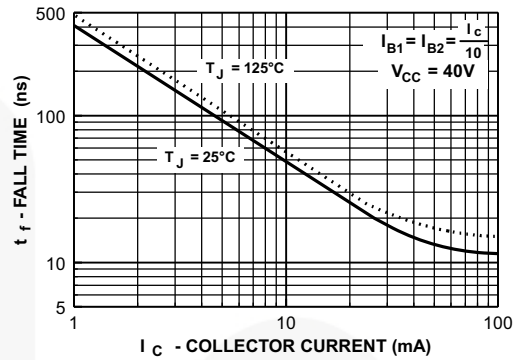

Figure 20. Fall Time vs. Collector Current

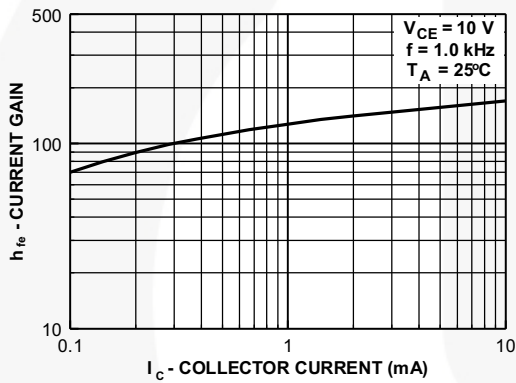

Figure 21. Current Gain

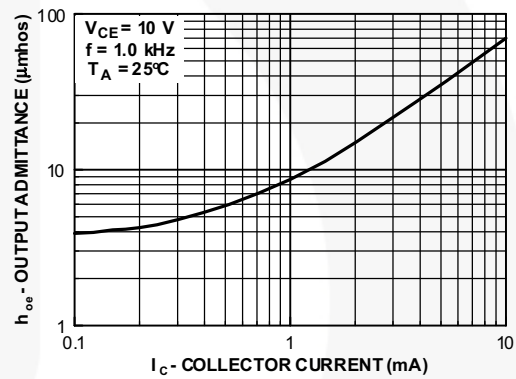

Figure 22. Output Admittance

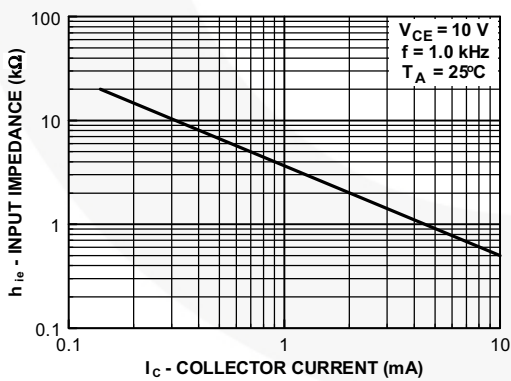

Figure 23. Input Impedance

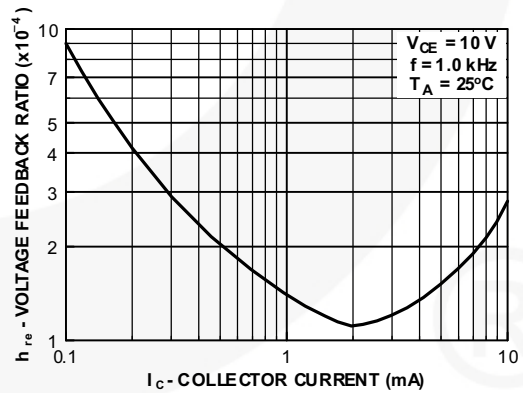
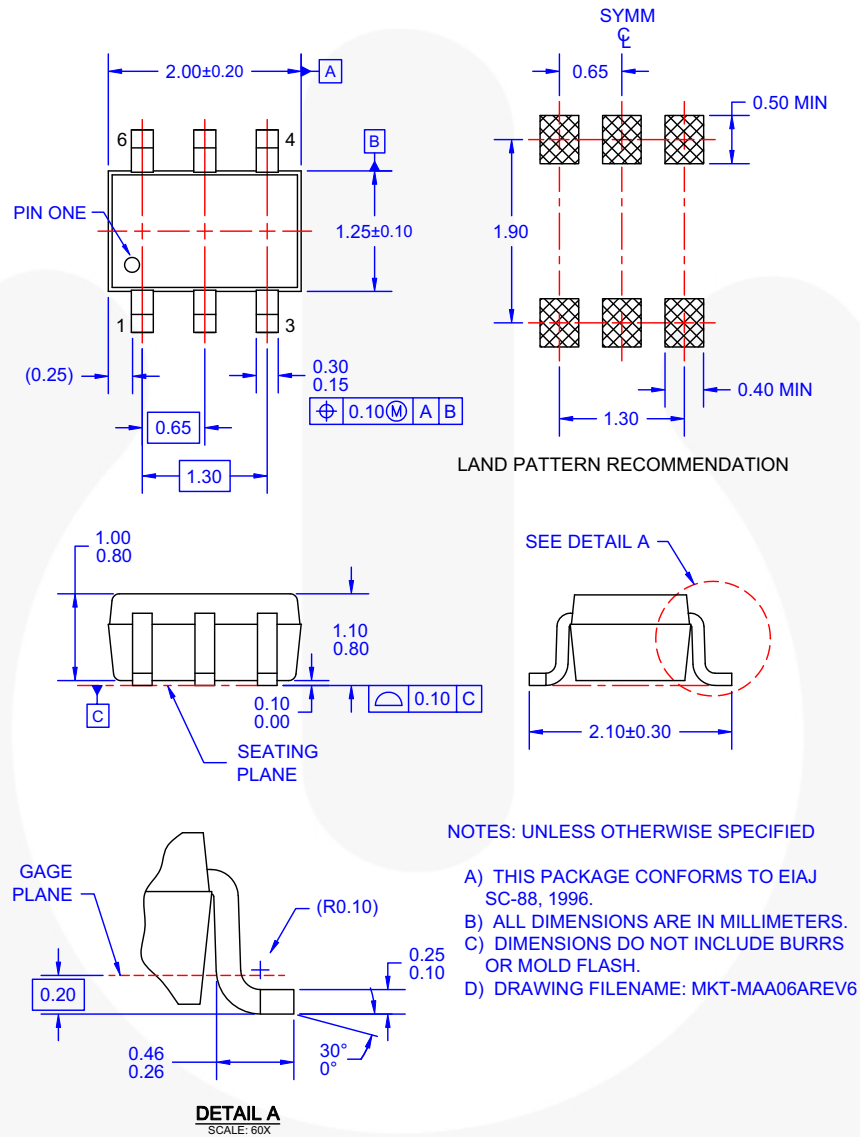

Figure 24. Voltage Feedback Ratio

## Physical Dimensions

### SC70 6L



**Figure 25. 6-LEAD, SC70, EIAJ SC-88, 1.25 MM WIDE (ACTIVE)**

Package drawings are provided as a service to customers considering Fairchild components. Drawings may change in any manner without notice. Please note the revision and/or date on the drawing and contact a Fairchild Semiconductor representative to verify or obtain the most recent revision. Package specifications do not expand the terms of Fairchild's worldwide terms and conditions, specifically the warranty therein, which covers Fairchild products.

Always visit Fairchild Semiconductor's online packaging area for the most recent package drawings:  
<http://www.fairchildsemi.com/dwg/MA/MAA06A.pdf>

For current tape and reel specifications, visit Fairchild Semiconductor's online packaging area:  
[http://www.fairchildsemi.com/packaging\\_dwg/PKG-MAA06A.pdf](http://www.fairchildsemi.com/packaging_dwg/PKG-MAA06A.pdf)



Physical Dimensions (Continued)

SSOT 6L

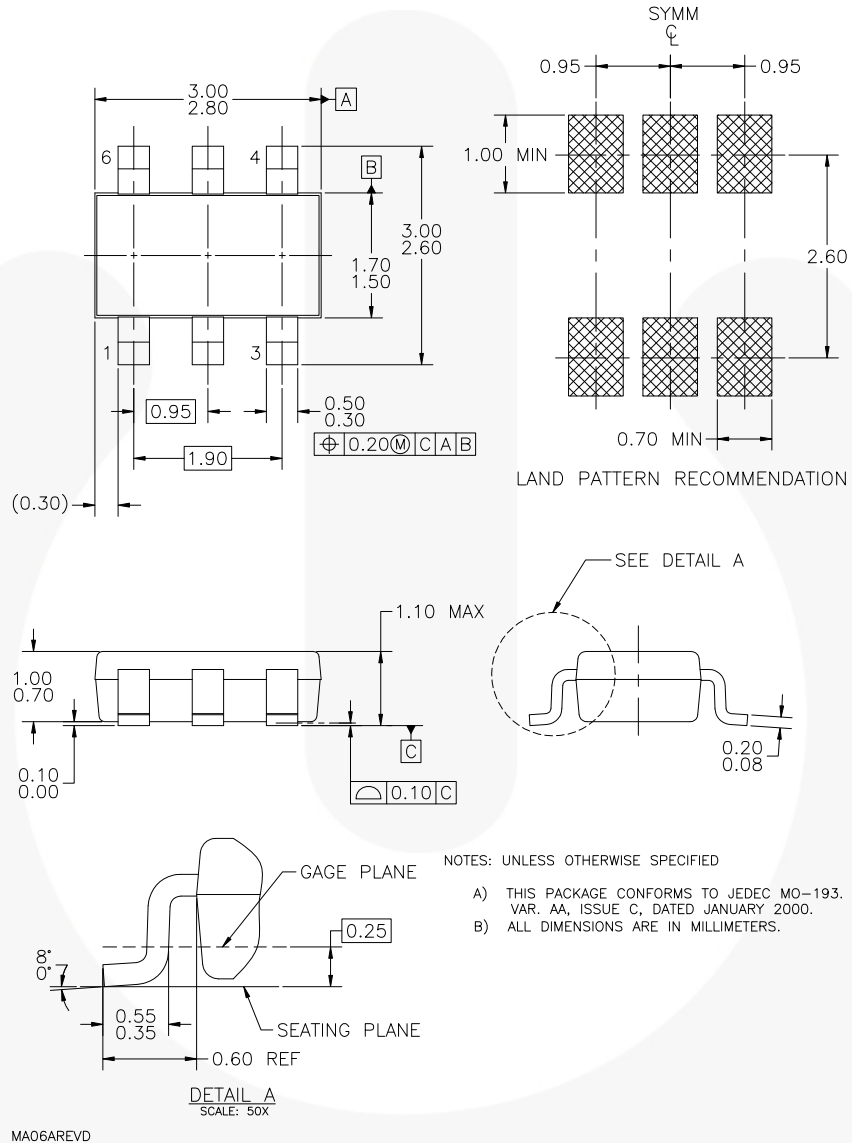

Figure 26. 6-LEAD, SUPERSOT-6, JEDEC MO-193, 1.6 MM WIDE (ACTIVE)

Package drawings are provided as a service to customers considering Fairchild components. Drawings may change in any manner without notice. Please note the revision and/or date on the drawing and contact a Fairchild Semiconductor representative to verify or obtain the most recent revision. Package specifications do not expand the terms of Fairchild's worldwide terms and conditions, specifically the warranty therein, which covers Fairchild products.

Always visit Fairchild Semiconductor's online packaging area for the most recent package drawings:  
<http://www.fairchildsemi.com/dwg/MA/MA06A.pdf>

For current tape and reel specifications, visit Fairchild Semiconductor's online packaging area:  
[http://www.fairchildsemi.com/packing\\_dwg/PKG-MA06A.pdf](http://www.fairchildsemi.com/packing_dwg/PKG-MA06A.pdf)

Physical Dimensions (Continued)

SO 16L NB

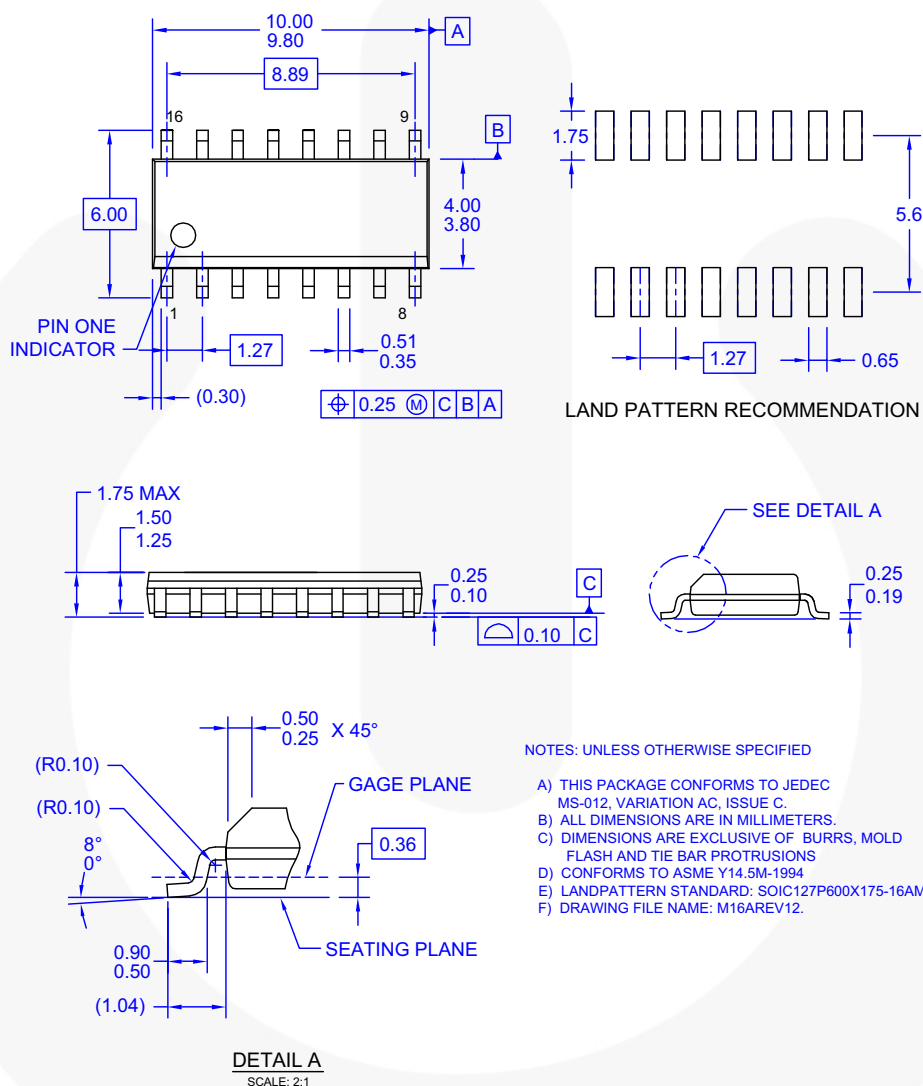

Figure 27. 16-LEAD, SOIC, JEDEC MS-012, 0.150 inch, NARROW BODY (ACTIVE)

Package drawings are provided as a service to customers considering Fairchild components. Drawings may change in any manner without notice. Please note the revision and/or date on the drawing and contact a Fairchild Semiconductor representative to verify or obtain the most recent revision. Package specifications do not expand the terms of Fairchild's worldwide terms and conditions, specifically the warranty therein, which covers Fairchild products.





Always visit Fairchild Semiconductor's online packaging area for the most recent package drawings:  
<http://www.fairchildsemi.com/dwg/M1/M16A.pdf>

For current tape and reel specifications, visit Fairchild Semiconductor's online packaging area:  
[http://www.fairchildsemi.com/packing\\_dwg/PKG-M16A.pdf](http://www.fairchildsemi.com/packing_dwg/PKG-M16A.pdf)



**TRADEMARKS**

The following includes registered and unregistered trademarks and service marks, owned by Fairchild Semiconductor and/or its global subsidiaries, and is not intended to be an exhaustive list of all such trademarks.

- |   |  |   |   |
|---|--|---|---|
| AccuPower™  | F-PFS™   |  | Sync-Lock™  |
| AX-CAP®*  | FRFET®   | PowerTrench®  |  |
| BitSiC™   | Global Power Resource™                         | PowerXS™  | TinyBoost®  |
| Build it Now™   | GreenBridge™                                   | Programmable Active Droop™  | TinyBuck®   |
| CorePLUS™   | Green FPS™                                     | QFET®   | TinyCalc™   |
| CorePOWER™  | Green FPS™ e-Series™                           | QS™   | TinyLogic®  |
| CROSSVOLT™  | Gmax™  | Quiet Series™   | TINYOPTO™   |
| CTL™  | GTO™   | RapidConfigure™   | TinyPower™  |
| Current Transfer Logic™   | IntelliMAX™                                    |  | TinyPWM™  |
| DEUXPEED®   | ISOPLANAR™                                     | Saving our world, 1mW/W/kW at a time™   | TinyWire™   |
| Dual Cool™  | Making Small Speakers Sound Louder and Better™ | SmartMax™   | TranSiC™  |
| EcoSPARK®   | MegaBuck™                                      | SMART START™  | TriFault Detect™  |
| EfficientMax™   | MICROCOUPLER™                                  | Solutions for Your Success™   | TRUECURRENT®*   |
| ESBC™   | MicroFET™                                      | SPM®  | μSerDes™  |
|  | MicroPak™                                      | STEALTH™  |  |
| Fairchild®  | MicroPak2™                                     | SuperFET®   | UHC®  |
| Fairchild Semiconductor®  | MillerDrive™                                   | SuperSOT™-3   | Ultra FRFET™  |
| FACT Quiet Series™  | MotionMax™                                     | SuperSOT™-6   | UniFET™   |
| FACT®   | mWSaver®                                       | SuperSOT™-8   | VcX™  |
| FAST®   | OptoHiT™                                       | SupreMOS®   | VisualMax™  |
| FastvCore™  | OPTOLOGIC®                                     | SyncFET™  | VoltagePlus™  |
| FETBench™   | OPTOPLANAR®                                    |   | XS™   |
| FPS™  |  |   |   |

\* Trademarks of System General Corporation, used under license by Fairchild Semiconductor.

**DISCLAIMER**

FAIRCHILD SEMICONDUCTOR RESERVES THE RIGHT TO MAKE CHANGES WITHOUT FURTHER NOTICE TO ANY PRODUCTS HEREIN TO IMPROVE RELIABILITY, FUNCTION, OR DESIGN. FAIRCHILD DOES NOT ASSUME ANY LIABILITY ARISING OUT OF THE APPLICATION OR USE OF ANY PRODUCT OR CIRCUIT DESCRIBED HEREIN; NEITHER DOES IT CONVEY ANY LICENSE UNDER ITS PATENT RIGHTS, NOR THE RIGHTS OF OTHERS. THESE SPECIFICATIONS DO NOT EXPAND THE TERMS OF FAIRCHILD'S WORLDWIDE TERMS AND CONDITIONS, SPECIFICALLY THE WARRANTY THEREIN, WHICH COVERS THESE PRODUCTS.

**LIFE SUPPORT POLICY**

FAIRCHILD'S PRODUCTS ARE NOT AUTHORIZED FOR USE AS CRITICAL COMPONENTS IN LIFE SUPPORT DEVICES OR SYSTEMS WITHOUT THE EXPRESS WRITTEN APPROVAL OF FAIRCHILD SEMICONDUCTOR CORPORATION.

As used herein:

1. Life support devices or systems are devices or systems which, (a) are intended for surgical implant into the body or (b) support or sustain life, and (c) whose failure to perform when properly used in accordance with instructions for use provided in the labeling, can be reasonably expected to result in a significant injury of the user.
2. A critical component in any component of a life support, device, or system whose failure to perform can be reasonably expected to cause the failure of the life support device or system, or to affect its safety or effectiveness.

**ANTI-COUNTERFEITING POLICY**

Fairchild Semiconductor Corporation's Anti-Counterfeiting Policy. Fairchild's Anti-Counterfeiting Policy is also stated on our external website, [www.fairchildsemi.com](http://www.fairchildsemi.com), under Sales Support.

Counterfeiting of semiconductor parts is a growing problem in the industry. All manufacturers of semiconductor products are experiencing counterfeiting of their parts. Customers who inadvertently purchase counterfeit parts experience many problems such as loss of brand reputation, substandard performance, failed applications, and increased cost of production and manufacturing delays. Fairchild is taking strong measures to protect ourselves and our customers from the proliferation of counterfeit parts. Fairchild strongly encourages customers to purchase Fairchild parts either directly from Fairchild or from Authorized Fairchild Distributors who are listed by country on our web page cited above. Products customers buy either from Fairchild directly or from Authorized Fairchild Distributors are genuine parts, have full traceability, meet Fairchild's quality standards for handling and storage and provide access to Fairchild's full range of up-to-date technical and product information. Fairchild and our Authorized Distributors will stand behind all warranties and will appropriately address any warranty issues that may arise. Fairchild will not provide any warranty coverage or other assistance for parts bought from Unauthorized Sources. Fairchild is committed to combat this global problem and encourage our customers to do their part in stopping this practice by buying direct or from authorized distributors.

**PRODUCT STATUS DEFINITIONS**

**Definition of Terms**

Datasheet Identification	Product Status	Definition
Advance Information	Formative / In Design	Datasheet contains the design specifications for product development. Specifications may change in any manner without notice.
Preliminary	First Production	Datasheet contains preliminary data; supplementary data will be published at a later date. Fairchild Semiconductor reserves the right to make changes at any time without notice to improve design.
No Identification Needed	Full Production	Datasheet contains final specifications. Fairchild Semiconductor reserves the right to make changes at any time without notice to improve the design.
Obsolete	Not In Production	Datasheet contains specifications on a product that is discontinued by Fairchild Semiconductor. The datasheet is for reference information only.

Rev. I66

ON Semiconductor and  are trademarks of Semiconductor Components Industries, LLC dba ON Semiconductor or its subsidiaries in the United States and/or other countries. ON Semiconductor owns the rights to a number of patents, trademarks, copyrights, trade secrets, and other intellectual property. A listing of ON Semiconductor's product/patent coverage may be accessed at [www.onsemi.com/site/pdf/Patent-Marking.pdf](http://www.onsemi.com/site/pdf/Patent-Marking.pdf). ON Semiconductor reserves the right to make changes without further notice to any products herein. ON Semiconductor makes no warranty, representation or guarantee regarding the suitability of its products for any particular purpose, nor does ON Semiconductor assume any liability arising out of the application or use of any product or circuit, and specifically disclaims any and all liability, including without limitation special, consequential or incidental damages. Buyer is responsible for its products and applications using ON Semiconductor products, including compliance with all laws, regulations and safety requirements or standards, regardless of any support or applications information provided by ON Semiconductor. "Typical" parameters which may be provided in ON Semiconductor data sheets and/or specifications can and do vary in different applications and actual performance may vary over time. All operating parameters, including "Typicals" must be validated for each customer application by customer's technical experts. ON Semiconductor does not convey any license under its patent rights nor the rights of others. ON Semiconductor products are not designed, intended, or authorized for use as a critical component in life support systems or any FDA Class 3 medical devices or medical devices with a same or similar classification in a foreign jurisdiction or any devices intended for implantation in the human body. Should Buyer purchase or use ON Semiconductor products for any such unintended or unauthorized application, Buyer shall indemnify and hold ON Semiconductor and its officers, employees, subsidiaries, affiliates, and distributors harmless against all claims, costs, damages, and expenses, and reasonable attorney fees arising out of, directly or indirectly, any claim of personal injury or death associated with such unintended or unauthorized use, even if such claim alleges that ON Semiconductor was negligent regarding the design or manufacture of the part. ON Semiconductor is an Equal Opportunity/Affirmative Action Employer. This literature is subject to all applicable copyright laws and is not for resale in any manner.

## PUBLICATION ORDERING INFORMATION

### LITERATURE FULFILLMENT:

Literature Distribution Center for ON Semiconductor  
19521 E. 32nd Pkwy, Aurora, Colorado 80011 USA  
**Phone:** 303-675-2175 or 800-344-3860 Toll Free USA/Canada  
**Fax:** 303-675-2176 or 800-344-3867 Toll Free USA/Canada  
**Email:** [orderlit@onsemi.com](mailto:orderlit@onsemi.com)

**N. American Technical Support:** 800-282-9855 Toll Free  
USA/Canada  
**Europe, Middle East and Africa Technical Support:**  
Phone: 421 33 790 2910  
**Japan Customer Focus Center**  
Phone: 81-3-5817-1050

**ON Semiconductor Website:** [www.onsemi.com](http://www.onsemi.com)  
**Order Literature:** <http://www.onsemi.com/orderlit>  
For additional information, please contact your local  
Sales Representative