

ADP8863* Product Page Quick Links

Last Content Update: 11/01/2016

[Comparable Parts](#)

View a parametric search of comparable parts

[Evaluation Kits](#)

- [ADP8863 Evaluation Board](#)

[Documentation](#)

Data Sheet

- [ADP8863: Charge Pump, 7-Channel Fun Lighting LED Driver Data Sheet](#)

User Guides

- [UG-005: Software User Guide](#)

[Software and Systems Requirements](#)

- [ADP8860 Back-light LED Linux Driver](#)

[Design Resources](#)

- [ADP8863 Material Declaration](#)
- [PCN-PDN Information](#)
- [Quality And Reliability](#)
- [Symbols and Footprints](#)

[Discussions](#)

View all ADP8863 EngineerZone Discussions

[Sample and Buy](#)

Visit the product page to see pricing options

[Technical Support](#)

Submit a technical question or find your regional support number

TABLE OF CONTENTS

Features	1	Automated RGB Color Fades	15
Applications.....	1	Backlight Operating Levels	16
Typical Operating Circuit.....	1	Backlight Turn On/Turn Off/Dim	16
General Description	1	Automatic Dim and Turn Off Timers	16
Revision History	2	Fade Override	17
Specifications.....	3	Ambient Light Sensing	17
I ² C Timing Diagram	4	Automatic Backlight Adjustment.....	18
Absolute Maximum Ratings.....	5	Using the ADP8863 to Drive Additional LEDs.....	19
Maximum Temperature Ranges	5	Operating LEDs from Alternative Supplies	20
Thermal Resistance	5	Short-Circuit Protection Mode	21
ESD Caution.....	5	Overvoltage Protection.....	21
Pin Configuration and Function Descriptions.....	6	Thermal Shutdown/Overtemperature Protection	21
Typical Performance Characteristics	7	Interrupts.....	21
Theory of Operation	11	Applications Information	23
Power Stage.....	12	Layout Guidelines.....	23
Operating Modes.....	13	I ² C Programming and Digital Control.....	24
LED Groupings	14	Backlight Register Descriptions	29
LED Current Settings.....	14	Independent Sink Register Descriptions.....	36
Automated Fade In and Fade Out	14	Comparator Register Descriptions	44
Independent Sink Control.....	15	Outline Dimensions	48
RGB Color Generation	15	Ordering Guide	49

REVISION HISTORY

6/10—Rev. 0 to Rev. A

Changes to Features Section and General Description Section .	1
Changes to Thermal Resistance Section and Table 3.....	5
Added Figure 4; Renumbered Sequentially	6
Changes to Table 4.....	6
Updated Outline Dimensions	48
Changes to Ordering Guide	49

4/10—Revision 0: Initial Version

SPECIFICATIONS

$V_{IN} = 3.6\text{ V}$, $SCL = 2.7\text{ V}$, $SDA = 2.7\text{ V}$, $nINT = \text{open}$, $nRST = 2.7\text{ V}$, $CMP_IN = 0\text{ V}$, $V_{D1:D7} = 0.4\text{ V}$, Capacitor $C1 = 1\text{ }\mu\text{F}$, Capacitor $C2 = 1\text{ }\mu\text{F}$, $C_{OUT} = 1\text{ }\mu\text{F}$, typical values are at $T_A = 25^\circ\text{C}$ and are not guaranteed, minimum and maximum limits are guaranteed from $T_A = -40^\circ\text{C}$ to $+85^\circ\text{C}$, unless otherwise noted.

Table 1.

Parameter	Symbol	Test Conditions/Comments	Min	Typ	Max	Unit
SUPPLY						
Input Voltage						
Operating Range	V_{IN}		2.5		5.5	V
Start-Up Level	$V_{IN(START)}$	V_{IN} increasing		2.05	2.30	V
Low Level	$V_{IN(STOP)}$	V_{IN} decreasing	1.75	1.97		V
$V_{IN(START)}$ Hysteresis	$V_{IN(HYS)}$	After startup		80		mV
UVLO Noise Filter	t_{UVLO}			10		μs
Quiescent Current	I_Q					
Prior to $V_{IN(START)}$	$I_{Q(START)}$	$V_{IN} = V_{IN(START)} - 100\text{ mV}$		10		μA
During Standby	$I_{Q(STBY)}$	$V_{IN} = 3.6\text{ V}$, Bit $nSTBY = 0$, $SCL = SDA = 0\text{ V}$		0.3	1.0	μA
After Startup and Switching	$I_{Q(ACTIVE)}$	$V_{IN} = 3.6\text{ V}$, Bit $nSTBY = 1$, $I_{OUT} = 0\text{ mA}$, gain = 2X		4.5	7.2	mA
OSCILLATOR						
Switching Frequency	f_{SW}		0.8	1	1.32	MHz
Duty Cycle	D			50		%
OUTPUT CURRENT CONTROL						
Maximum Drive Current	$I_{D1:D7(MAX)}$	$V_{D1:D7} = 0.4\text{ V}$				
D1 to D7		Bit $SCR = 0$ in the ISC7 register				
$T_J = 25^\circ\text{C}$			26.2	30	34.1	mA
$T_J = -40^\circ\text{C}$ to $+85^\circ\text{C}$			24.4		34.1	mA
D7 Only (60 mA Setting)	$I_{D7(60\text{ mA})}$	$V_{D7} = 0.4\text{ V}$, Bit $SCR = 1$ in the ISC7 register				
$T_J = 25^\circ\text{C}$			52.5	60	67	mA
$T_J = -40^\circ\text{C}$ to $+85^\circ\text{C}$			48.8		67	mA
LED Current Source Matching ¹	I_{MATCH}					
All Current Sinks	I_{MATCH7}	$V_{D1:D7} = 0.4\text{ V}$		2.0		%
D2 to D7 Current Sinks	I_{MATCH6}	$V_{D2:D7} = 0.4\text{ V}$		1.5		%
Leakage Current on LED Pins	$I_{D1:D7(LKG)}$	$V_{IN} = 5.5\text{ V}$, $V_{D1:D7} = 2.5\text{ V}$, Bit $nSTBY = 1$			0.5	μA
Equivalent Output Resistance	R_{OUT}					
Gain = 1X		$V_{IN} = 3.6\text{ V}$, $I_{OUT} = 100\text{ mA}$		0.5		Ω
Gain = 1.5X		$V_{IN} = 3.1\text{ V}$, $I_{OUT} = 100\text{ mA}$		3.0		Ω
Gain = 2X		$V_{IN} = 2.5\text{ V}$, $I_{OUT} = 100\text{ mA}$		3.8		Ω
Regulated Output Voltage	$V_{OUT(REG)}$	$V_{IN} = 3\text{ V}$, gain = 2X, $I_{OUT} = 10\text{ mA}$	4.3	4.9	5.5	V
AUTOMATIC GAIN SELECTION						
Minimum Voltage						
Gain Increases	$V_{HR(UP)}$	Decrease $V_{D1:D7}$ until the gain switches up	162	200	276	mV
Minimum Current Sink Headroom Voltage	$V_{HR(MIN)}$	$I_{DX} = I_{DX(MAX)} \times 95\%$		180		mV
Gain Delay	t_{GAIN}	The delay after gain has changed and before gain is allowed to change again		100		μs
AMBIENT LIGHT SENSING COMPARATORS						
Ambient Light Sensor Current	I_{ALS}	$CMP_IN = V_{D6} = 2.8\text{ V}$, Bit $CMP2_SEL = 1$	0.70	1.08	1.33	mA
DAC Bit Step						
Threshold L2 Level	I_{L2BIT}	$I_{L2BIT} = I_{ALS}/250$		4.3		μA
Threshold L3 Level	I_{L3BIT}	$I_{L3BIT} = I_{ALS}/2000$		0.54		μA

ADP8863

Parameter	Symbol	Test Conditions/Comments	Min	Typ	Max	Unit
FAULT PROTECTION						
Start-Up Charging Current Source	I_{SS}	$V_{IN} = 3.6\text{ V}, V_{OUT} = 0.8 \times V_{IN}$	2.5	3.75	5.5	mA
Output Voltage Threshold	V_{OUT}					
Exit Soft Start	$V_{OUT(START)}$	V_{OUT} rising		$0.92 \times V_{IN}$		V
Short-Circuit Protection	$V_{OUT(SC)}$	V_{OUT} falling		$0.55 \times V_{IN}$		V
Output Overvoltage Protection	V_{OVP}					
Activation Level				5.8		V
OVP Recovery Hysteresis	$V_{OVP(HYS)}$			500		mV
Thermal Shutdown						
Threshold	TSD			150		°C
Hysteresis	$TSD_{(HYS)}$			20		°C
Isolation from Input to Output During Fault	I_{OUTLKG}	$V_{IN} = 5.5\text{ V}, V_{OUT} = 0\text{ V}, \text{Bit nSTBY} = 0$			1.5	μA
Time to Validate a Fault	t_{FAULT}			2		μs
I²C INTERFACE						
Operating V_{DDIO} Voltage	V_{DDIO}				5.5	V
Logic Low Input ²	V_{IL}	$V_{IN} = 3.6\text{ V}$			0.6	V
Logic High Input ³	V_{IH}	$V_{IN} = 3.6\text{ V}$	1.30			V
I²C TIMING SPECIFICATIONS						
Delay from Reset Deassertion to I ² C Access	t_{RESET}	Guaranteed by design			20	μs
SCL Frequency	f_{SCL}				400	kHz
SCL High Time	t_{HIGH}		0.6			μs
SCL Low Time	t_{LOW}		1.3			μs
Setup Time						
Data	$t_{SU, DAT}$		100			ns
Repeated Start	$t_{SU, STA}$		0.6			μs
Stop Condition	$t_{SU, STO}$		0.6			μs
Hold Time						
Data	$t_{HD, DAT}$		0		0.9	μs
Start/Repeated Start	$t_{HD, STA}$		0.6			μs
Bus Free Time (Stop and Start Conditions)	t_{BUF}		1.3			μs
Rise Time (SCL and SDA)	t_R		$20 + 0.1 C_B$		300	ns
Fall Time (SCL and SDA)	t_F		$20 + 0.1 C_B$		300	ns
Pulse Width of Suppressed Spike	t_{SP}		0		50	ns
Capacitive Load per Bus Line	C_B				400	pF

¹ Current source matching is calculated by dividing the difference between the maximum and minimum current from the sum of the maximum and minimum.

² V_{IL} is a function of the input voltage. See Figure 16 in the Typical Performance Characteristics section for typical values over operating ranges.

³ V_{IH} is a function of the input voltage. See Figure 16 in the Typical Performance Characteristics section for typical values over operating ranges.

I²C TIMING DIAGRAM

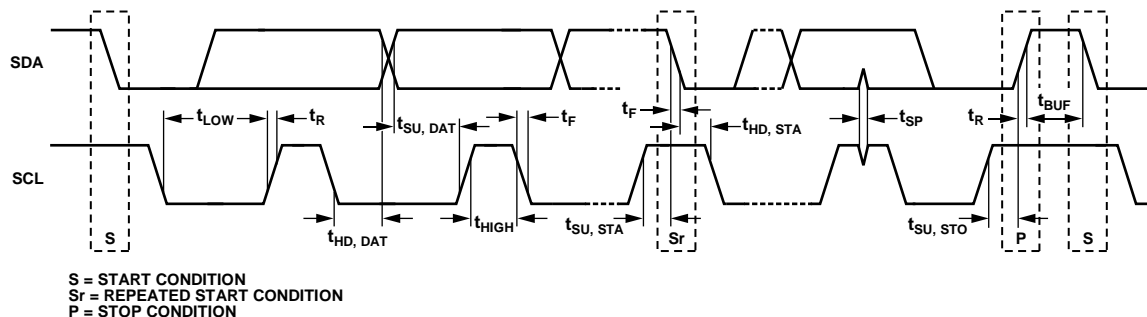

Figure 2. I²C Interface Timing Diagram

ABSOLUTE MAXIMUM RATINGS

Table 2.

Parameter	Rating
VIN, VOUT	–0.3 V to +6 V
D1, D2, D3, D4, D5, D6, and D7	–0.3 V to +6 V
CMP_IN	–0.3 V to +6 V
nINT, nRST, SCL, and SDA	–0.3 V to +6 V
Output Short-Circuit Duration	Indefinite
Operating Ambient Temperature Range	–40°C to +85°C ¹
Operating Junction Temperature Range	–40°C to +125°C
Storage Temperature Range	–65°C to +150°C
Soldering Conditions	JEDEC J-STD-020
ESD (Electrostatic Discharge)	
Human Body Model (HBM)	±3 kV
Charged Device Model (CDM)	±1.5 kV

¹ The maximum operating junction temperature ($T_{J(MAX)}$) takes precedence over the maximum operating ambient temperature ($T_{A(MAX)}$). See the Maximum Temperature Ranges section for more information.

Stresses above those listed under Absolute Maximum Ratings may cause permanent damage to the device. This is a stress rating only; functional operation of the device at these or any other conditions above those indicated in the operational section of this specification is not implied. Exposure to absolute maximum rating conditions for extended periods may affect device reliability.

Absolute maximum ratings apply individually only, not in combination. Unless otherwise specified, all voltages are referenced to ground.

MAXIMUM TEMPERATURE RANGES

The maximum operating junction temperature ($T_{J(MAX)}$) takes precedence over the maximum operating ambient temperature ($T_{A(MAX)}$). Therefore, in situations where the ADP8863 is exposed to poor thermal resistance and high power dissipation (P_D), the maximum ambient temperature may need to be derated. In these cases, the maximum ambient temperature can be calculated with the following equation:

$$T_{A(MAX)} = T_{J(MAX)} - (\theta_{JA} \times P_{D(MAX)})$$

THERMAL RESISTANCE

θ_{JA} (junction to air) is specified for the worst-case conditions, that is, a device soldered in a circuit board for surface-mount packages. The θ_{JB} (junction to board), and θ_{JC} (junction to case) are determined according to JESD51-9 on a 4-layer printed circuit board (PCB) with natural convection cooling. For the LFCSP package, the exposed pad must be soldered to GND.

Table 3. Thermal Resistance

Package Type	θ_{JA}	θ_{JB}	θ_{JC}	Unit
WLCSP	48	9	N/A ¹	°C/W
LFCSP	49.5	N/A ¹	5.3	°C/W

¹ N/A stands for not applicable.

ESD CAUTION



ESD (electrostatic discharge) sensitive device. Charged devices and circuit boards can discharge without detection. Although this product features patented or proprietary protection circuitry, damage may occur on devices subjected to high energy ESD. Therefore, proper ESD precautions should be taken to avoid performance degradation or loss of functionality.

PIN CONFIGURATION AND FUNCTION DESCRIPTIONS

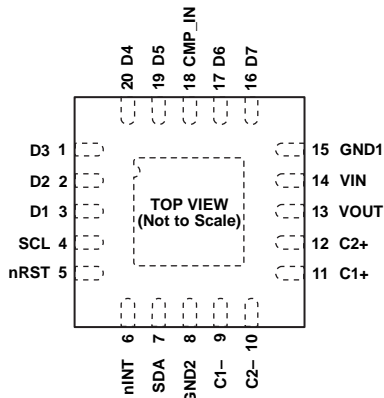

NOTES
1. CONNECT THE EXPOSED PADDLE TO GND1 AND/OR GND2.

Figure 3. LFCSP Pin Configuration

08392-003

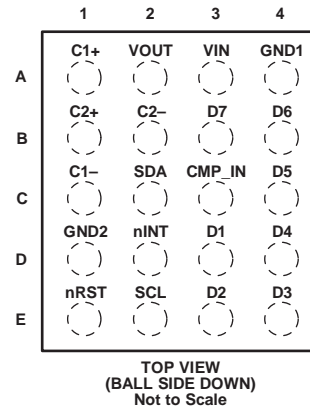

TOP VIEW
(BALL SIDE DOWN)
Not to Scale

08392-062

Figure 4. WLCSP Pin Configuration

Table 4. Pin Function Descriptions

Pin No.		Mnemonic	Description
LFCSP	WLCSP		
14	A3	VIN	Input Voltage, 2.5 V to 5.5 V.
3	D3	D1	LED Sink 1.
2	E3	D2	LED Sink 2.
1	E4	D3	LED Sink 3.
20	D4	D4	LED Sink 4.
19	C4	D5	LED Sink 5.
17	B4	D6	LED Sink 6. This pin can also be selected as a comparator input for the second phototransistor.
16	B3	D7	LED Sink 7.
18	C3	CMP_IN	Comparator Input for Phototransistor. When using this function, a capacitor (0.1 μ F recommended) must be connected from this pin to ground.
13	A2	VOUT	Charge Pump Output.
11	A1	C1+	Charge Pump C1+.
9	C1	C1-	Charge Pump C1-.
12	B1	C2+	Charge Pump C2+.
10	B2	C2-	Charge Pump C2-.
15	A4	GND1	Ground. Connect the exposed pad to GND1 and/or GND2.
8	D1	GND2	Ground. Connect the exposed pad to GND1 and/or GND2.
6	D2	nINT	Processor Interrupt (Active Low). Requires an external pull-up resistor. If this pin is not used, it can be left floating.
5	E1	nRST	Hardware Reset (Active Low). This pin resets the device to the default conditions. If not used, this pin must be tied above $V_{IH(MIN)}$.
7	C2	SDA	I ² C Serial Data. Requires an external pull-up resistor.
4	E2	SCL	I ² C Clock. Requires an external pull-up resistor.
21	NA	EPAD	Exposed Paddle. Connect the exposed paddle to GND1 and/or GND2.

TYPICAL PERFORMANCE CHARACTERISTICS

V_{IN} = 3.6 V, SCL = 2.7 V, SDA = 2.7 V, nRST = 2.7 V, V_{D1:D7} = 0.4 V, C_{IN} = 1 μF, Capacitor C1 = 1 μF, Capacitor C2 = 1 μF, C_{OUT} = 1 μF, T_A = 25°C, unless otherwise noted.

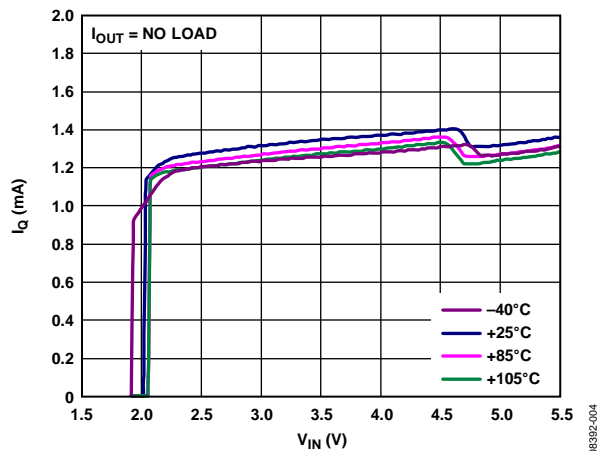

Figure 5. Typical Quiescent Current, G = 1×

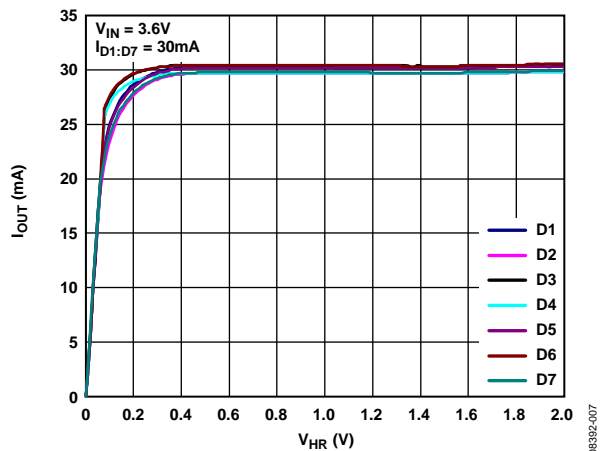

Figure 8. Typical Diode Current vs. Current Sink Headroom Voltage (V_{HR})

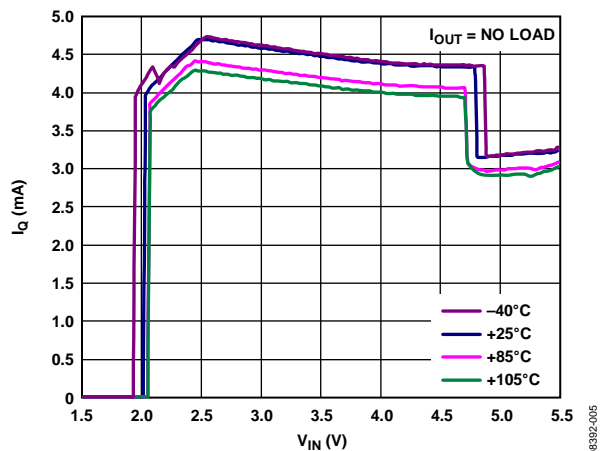

Figure 6. Typical Quiescent Current, G = 2×, I_{Q(ACTIVE)}

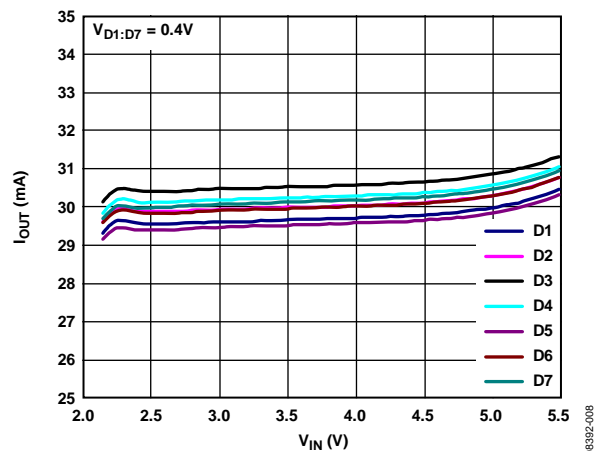

Figure 9. Typical Diode Matching vs. V_{IN}

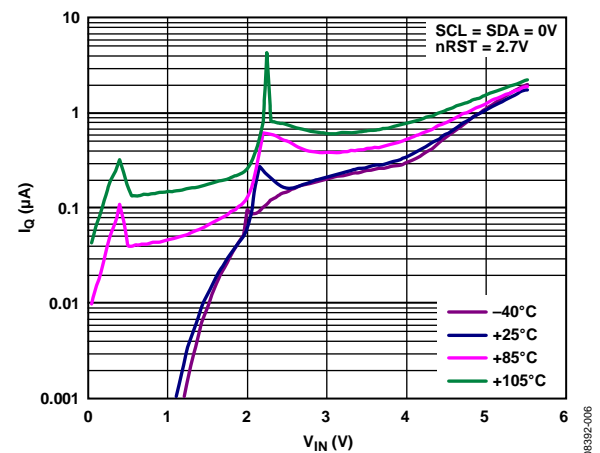

Figure 7. Typical Standby I_Q vs. V_{IN}

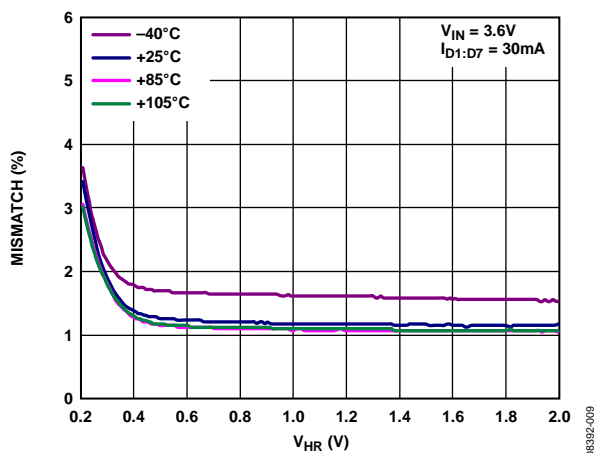

Figure 10. Typical Diode Matching vs. Current Sink Headroom Voltage (V_{HR})

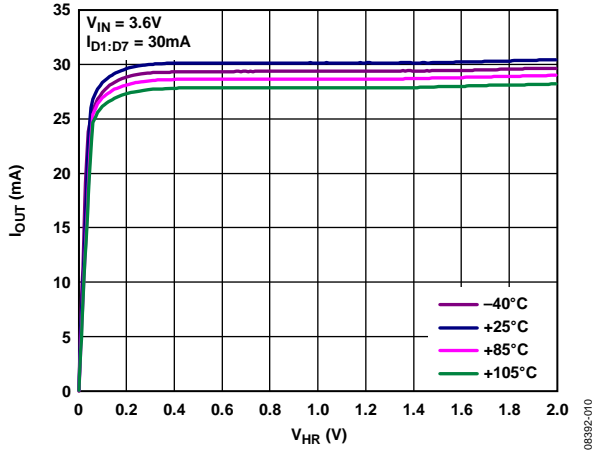

Figure 11. Typical Diode Current vs. Current Sink Headroom Voltage (V_{HR})

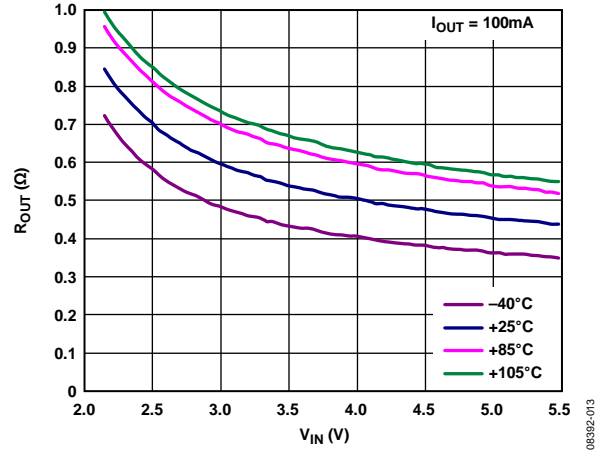

Figure 14. Typical R_{OUT} ($G = 1\times$) vs. V_{IN}

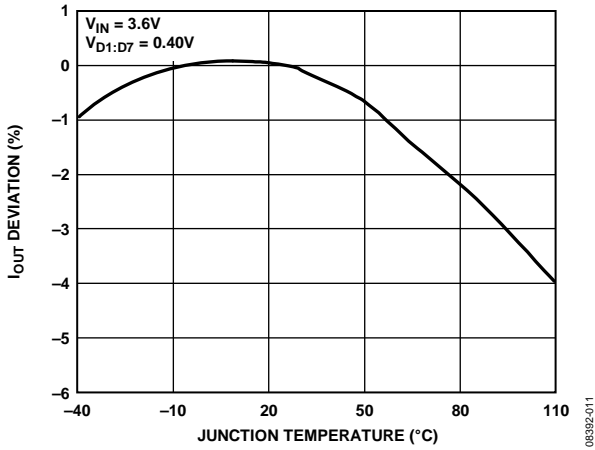

Figure 12. Typical Change In Diode Current vs. Temperature

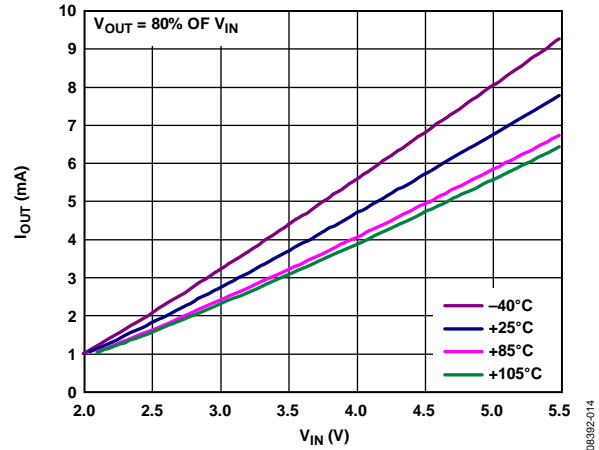

Figure 15. Typical Output Soft Start Current, I_{SS}

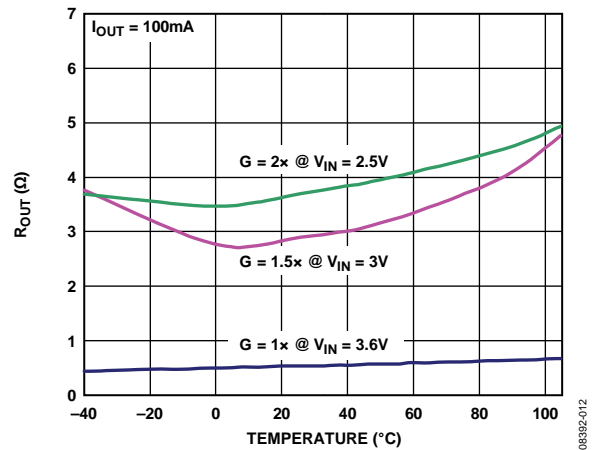

Figure 13. R_{OUT} vs. Temperature

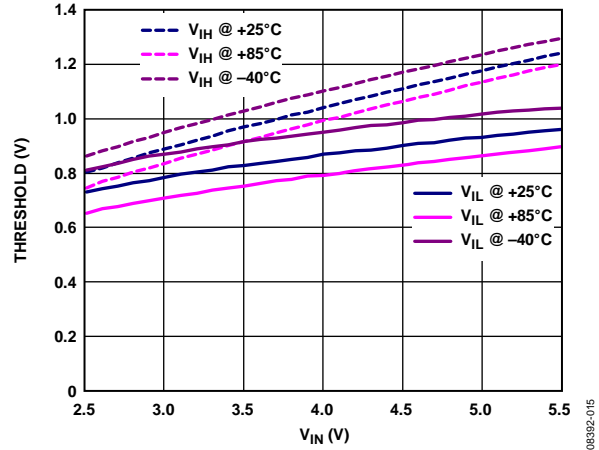

Figure 16. Typical PC Thresholds, V_{IH} and V_{IL}

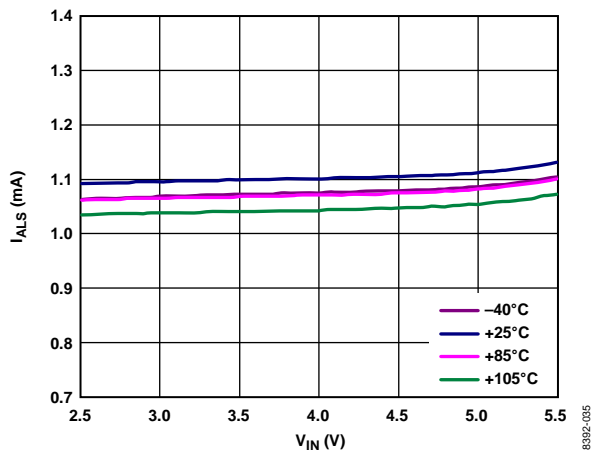

Figure 17. Typical ALS Current, I_{ALS}

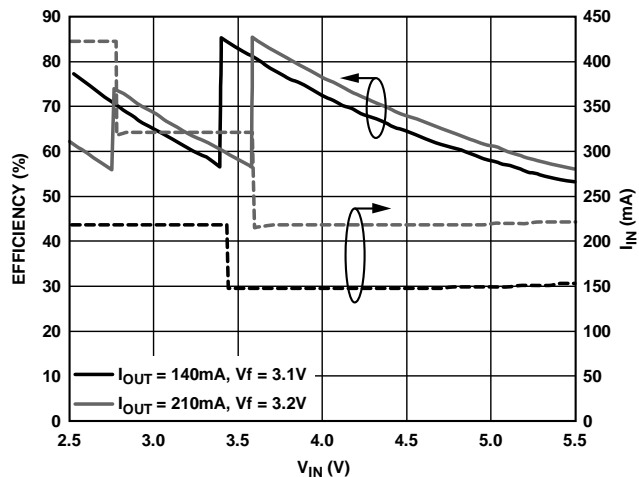

Figure 20. Typical Efficiency (Low Vf Diode)

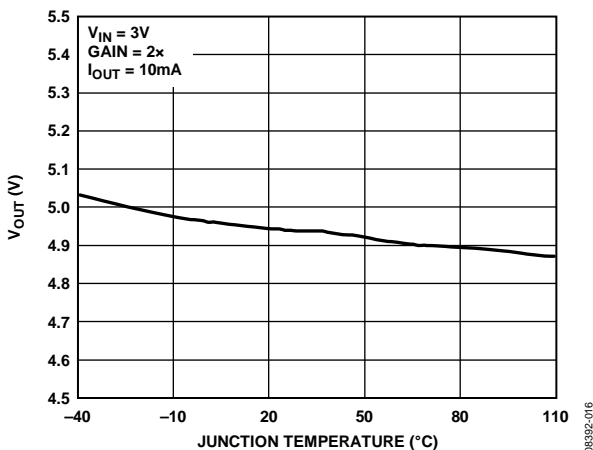

Figure 18. Typical Regulated Output Voltage ($V_{OUT(REG)}$)

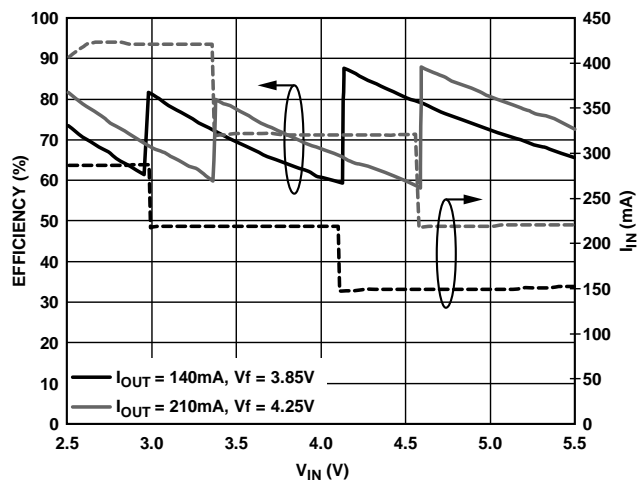

Figure 21. Typical Efficiency (High Vf Diode)

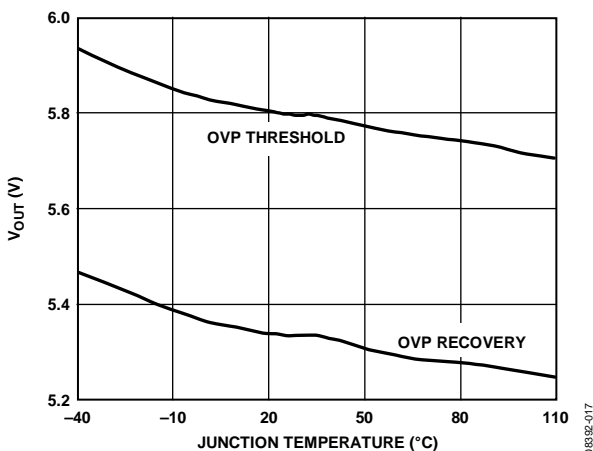

Figure 19. Typical Overvoltage Protection (OVP) Threshold

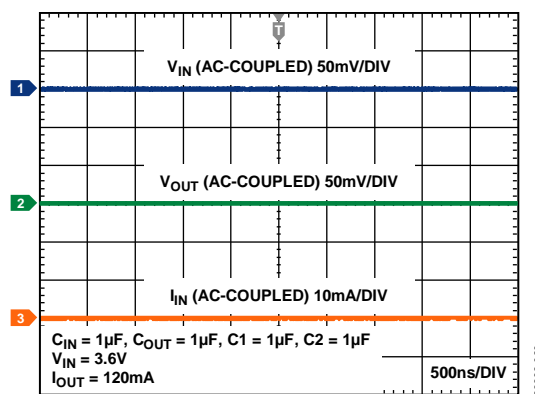

Figure 22. Typical Operating Waveforms, $G = 1\times$

ADP8863

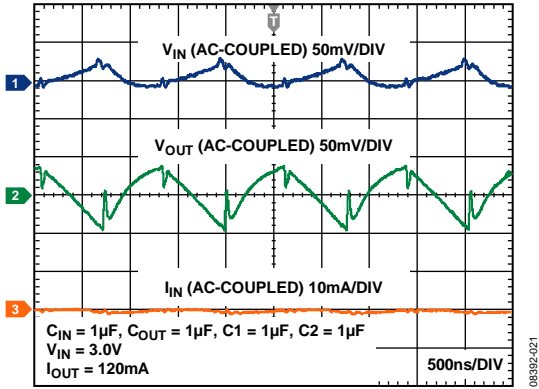

Figure 23. Typical Operating Waveforms, $G = 1.5\times$

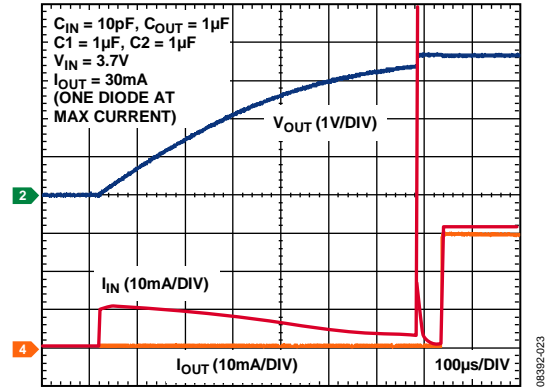

Figure 25. Typical Start-Up Waveform

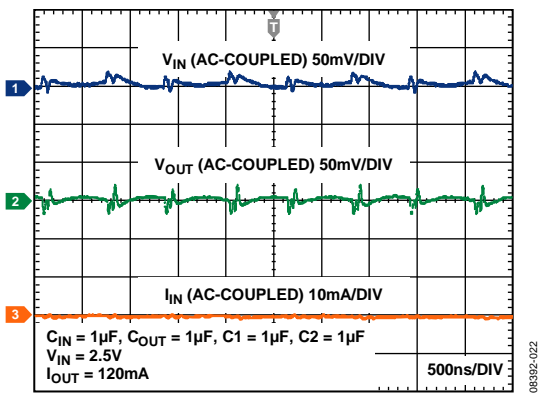

Figure 24. Typical Operating Waveforms, $G = 2\times$

POWER STAGE

Because typical white LEDs require up to 4 V to drive them, some form of boosting is required over the typical variation in battery voltage. The ADP8863 accomplishes this with a high efficiency charge pump capable of producing a maximum I_{OUT} of 240 mA over the entire input voltage range (2.5 V to 5.5 V). Charge pumps use the basic principle that a capacitor stores charge based on the voltage applied to it, as shown in the following equation:

$$Q = C \times V \quad (1)$$

By charging the capacitors in different configurations, the charge, and therefore the gain, can be optimized to deliver the voltage required to power the LEDs. Because a fixed charging and discharging combination must be used, only certain multiples of gain are available. The ADP8863 is capable of automatically optimizing the gain (G) from 1×, 1.5×, and 2×. These gains are accomplished with two capacitors (labeled C1 and C2 in Figure 26) and an internal switching network.

In $G = 1\times$ mode, the switches are configured to pass V_{IN} directly to V_{OUT} . In this mode, several switches are connected in parallel to minimize the resistive drop from input to output. In $G = 1.5\times$ and $2\times$ modes, the switches alternatively charge from the battery and discharge into the output. For $G = 1.5\times$, the capacitors are charged from V_{IN} in series and are discharged to V_{OUT} in parallel. For $G = 2\times$, the capacitors are charged from V_{IN}

in parallel and are discharged to V_{OUT} in parallel. In certain fault modes, the switches are opened and the output is physically isolated from the input.

Automatic Gain Selection

Each LED that is driven requires a current source. The voltage on this current source must be greater than a minimum headroom voltage (200 mV typical) to maintain accurate current regulation. The gain is automatically selected based on the minimum voltage (V_{DX}) at all of the current sources. At startup, the device is placed into $G = 1\times$ mode and the output charges to V_{IN} . If any V_{DX} level is less than the required headroom (200 mV), the gain is increased to the next step ($G = 1.5\times$). A 100 μs delay is allowed for the output to stabilize prior to the next gain switching decision. If there remains insufficient current sink headroom, then the gain is increased again to $2\times$. Conversely, to optimize efficiency, it is not desirable for the output voltage to be too high. Therefore, the gain reduces when the headroom voltage is great enough. This point (labeled V_{DMAX} in Figure 27) is internally calculated to ensure that the lower gain still results in ample headroom for all the current sinks. The entire cycle is illustrated in Figure 27.

Note that the gain selection criteria apply only to active current sources. If current sources have been deactivated through an I^2C command (for example, only five LEDs are used), then the voltages on the deactivated current sources are ignored.

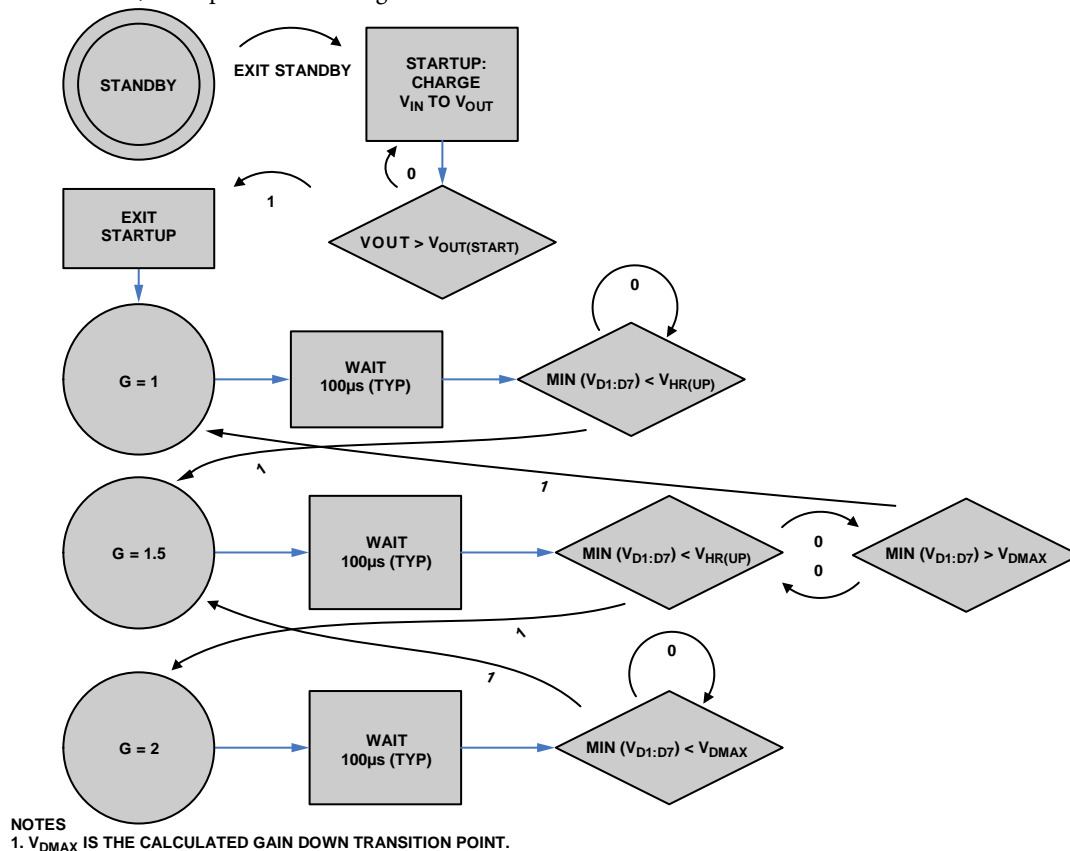

Figure 27. State Diagram for Automatic Gain Selection

Soft Start Feature

At startup (either from UVLO activation or fault/standby recovery), the output is first charged by I_{SS} (3.75 mA typical) until it reaches about 92% of V_{IN} . This soft start feature reduces the inrush current that is otherwise present when the output capacitance is initially charged to V_{IN} . When this point is reached, the controller enters $G = 1\times$ mode. If the output voltage is not sufficient, then the automatic gain selection determines the optimal point as defined in the Automatic Gain Selection section.

OPERATING MODES

There are four different operating modes: active, standby, shutdown, and reset.

Active Mode

In active mode, all circuits are powered up and in a fully operational state. This mode is entered when Bit nSTBY (in Register MDCR) is set to 1.

Standby Mode

Standby mode disables all circuitry except for the I²C receivers. Current consumption is reduced to less than 1 μ A. This mode is entered when the nSTBY bit is set to 0 or when the nRST pin is held low for more than 100 μ s (maximum). When standby is exited, a soft start sequence is performed.

Shutdown Mode

Shutdown mode disables all circuitry, including the I²C receivers. Shutdown occurs when V_{IN} is below the undervoltage thresholds. When V_{IN} rises above $V_{IN(START)}$ (2.05 V typical), all registers are reset and the part is placed into standby mode.

Reset Mode

In reset mode, all registers are set to their default values and the part is placed into standby. There are two ways to reset the part: by power-on reset (POR) or using the nRST pin. POR is activated any time that the part exits shutdown mode. After a POR sequence is complete, the part automatically enters standby mode.

After startup, the part can be reset by pulling the nRST pin low. As long as the nRST pin is low, the part is held in a standby state, but no I²C commands are acknowledged (all registers are kept at their default values). After releasing the nRST pin, all registers remain at their default values, and the part remains in standby; however, the part does accept I²C commands.

The nRST pin has a 50 μ s (typical) noise filter to prevent inadvertent activation of the reset function. The nRST pin must be held low for this entire time to activate reset.

The operating modes function according to the timing diagram in Figure 28.

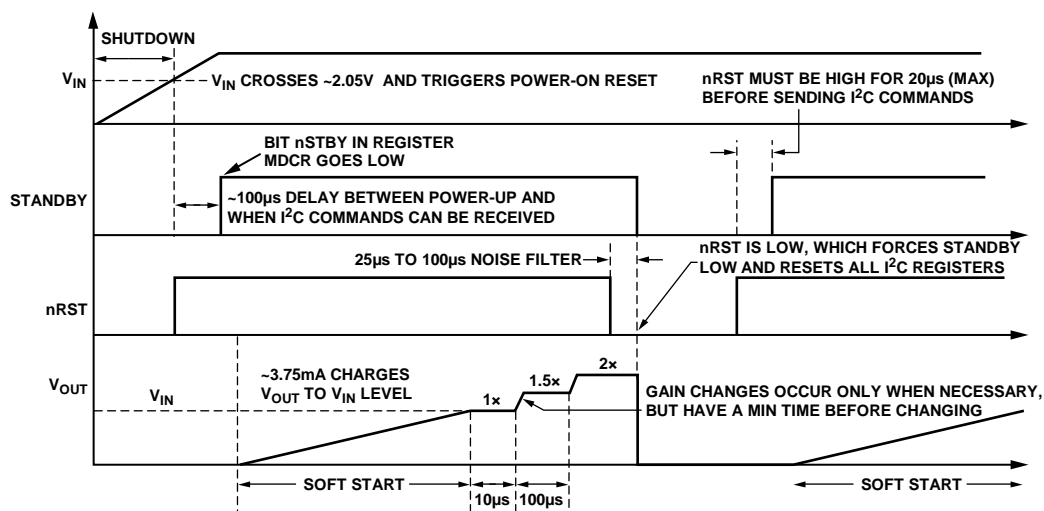

Figure 28. Typical Timing Diagram

08892-026

ADP8863

LED GROUPINGS

Each LED can respond individually or be grouped together into the backlight controls. By default, all LEDs are set to be part of the backlight. This is changed by setting Bits[6:0] in Register 0x05. LEDs that are set up as independent sinks can be enabled individually in Register 0x10. They can also all be enabled simultaneously via the SIS_EN bit in Register 0x01. Any LEDs configured for the backlight can only be enabled via the BL_EN bit in Register 0x01.

LED CURRENT SETTINGS

Any of the LED outputs (Pin D1 to Pin D7) can be used to drive any color of LED at 0 mA to 30 mA, provided that the LED's V_f is less than 4.1 V. Additionally, the D7 sink can regulate up to 60 mA. The current settings are determined by a 7-bit code programmed by the user into Register 0x14 through Register 0x1A (for the independent sinks) and Register 0x09 through Register 0x0E (for the backlight sinks). The 7-bit resolution allows the user to set the LED to one of 128 different levels.

The ADP8863 can implement two distinct algorithms to achieve a linear or a nonlinear relationship between input code and diode output current. The law and SC_LAW bits in Register 0x04 and Register 0x0F, respectively, are used to change between these algorithms.

By default, the ADP8863 uses a linear algorithm (law and SC_LAW = 00), where the LED current increases linearly for a corresponding increase in input code. LED current (in milliamperes) is determined by the following equation:

$$LED\ Current\ (mA) = Code \times (Full\ Scale\ Current/127) \quad (2)$$

where:

Code is the input code programmed by the user.

Full-Scale Current is the maximum sink current allowed per LED (typically 30 mA).

The ADP8863 can also implement a nonlinear (square approximation) relationship between input code and LED current. In this case (law and SC_LAW = 01, 10, or 11), the LED current (in milliamperes) is determined by the following equation:

$$LED\ Current\ (mA) = \left(Code \times \frac{\sqrt{Full\ Scale\ Current}}{127} \right)^2 \quad (3)$$

Figure 29 shows the LED current level vs. input code for both the linear and square law algorithms.

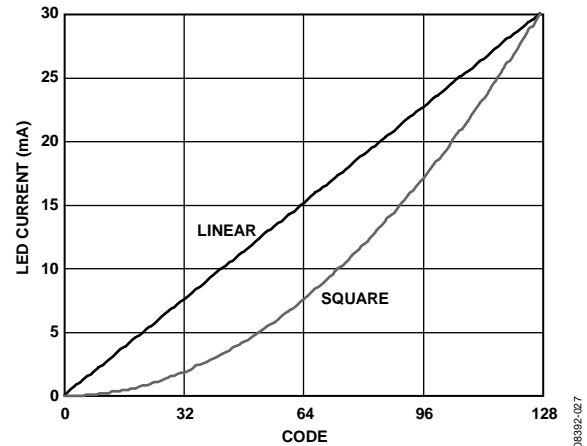

Figure 29. LED Current vs. Input Code

AUTOMATED FADE IN AND FADE OUT

The LED drivers are easily configured for automated fade in and fade out. Sixteen fade in and fade out rates can be selected via the I²C interface. Fade in and fade out rates range from 0.0 sec to 5.5 sec (per full-scale current, either 30 mA or 60 mA). The backlight LEDs have separate fade in and fade out time controls from the independent sink LEDs.

Table 5. Available Fade In and Fade Out Rates

Code	Fade Rate (in sec per Full-Scale Current)
0000	0.0 (disabled)
0001	0.3
0010	0.6
0011	0.9
0100	1.2
0101	1.5
0110	1.8
0111	2.1
1000	2.4
1001	2.7
1010	3.0
1011	3.5
1100	4.0
1101	4.5
1110	5.0
1111	5.5

The fade profile is based on the transfer law selected (linear, square, Cubic 10, or Cubic 11) and the delta between the actual current and the target current. Smaller changes in current reduce the fade time. For linear and square law fades, the fade time is given by

$$Fade\ Time = Fade\ Rate \times (Code/127) \quad (4)$$

where the *Fade Rate* is shown in Table 5.

The Cubic 10 and Cubic 11 laws also use the square law LED currents derived from Equation 3; however, the time between each step is varied to produce a steeper slope at higher currents and a shallower slope at lower currents (see Figure 30).

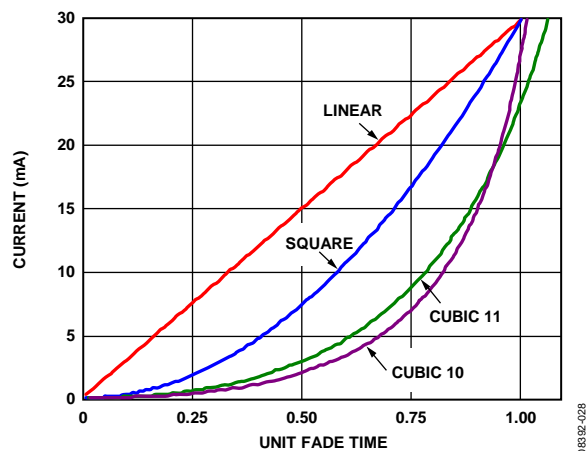

Figure 30. Comparison of the Dimming Transfers Laws

Each LED can be enabled independently and has its own current level, but all LEDs share the same fade in rates, fade out rates, and fade law.

INDEPENDENT SINK CONTROL

Each of the seven LEDs can be configured (in Register 0x05) to operate as either part of the backlight or to operate as an independent sink current (ISC). Each ISC can be enabled independently and has its own current level. All ISCs share the same fade in rates, fade out rates, and fade law.

The ISCs have additional timers to facilitate blinking functions. A shared on timer (SCON) in conjunction with the off timer of each ISC (SC1OFF, SC2OFF, SC3OFF, SC4OFF, SC5OFF, SC6OFF, and SC7OFF) allows the LED current sinks to be configured in various blinking modes. The on timer can be set to one of four different settings: 0.2 sec, 0.6 sec, 0.8 sec, or 1.2 sec. The off timers have four different settings: disabled, 0.6 sec, 1.2 sec, and 1.8 sec. Blink mode is activated by setting the off timers to any setting other than disabled.

Program all fade, on, and off timers before enabling any of the LED current sinks. If ISC_x is on during a blink cycle and SC_x_EN is cleared, the LED turns off (or fades to off if fade out is enabled). If ISC_x is off during a blink cycle and SC_x_EN is cleared, it stays off.

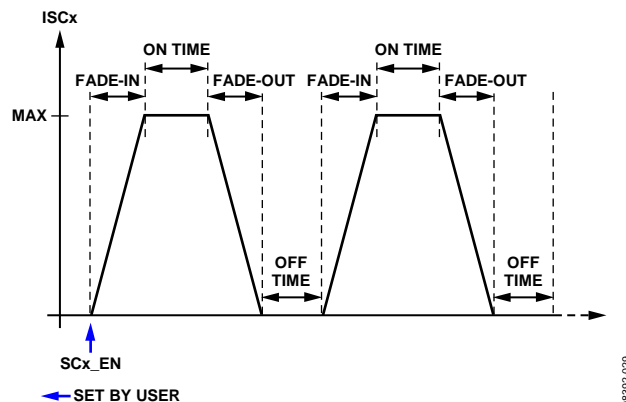

Figure 31. Independent Sink Blink Mode with Fading

RGB COLOR GENERATION

The ADP8863 is easily programmed to generate any color with an RGB LED. To configure this feature, connect each LED in a standard RGB diode to a separate driver on the ADP8863. Because each channel can be programmed for a different current level, setting the currents for all three LEDs generates the desired color. To set the current levels, use a simple RGB color selector (see Figure 32).

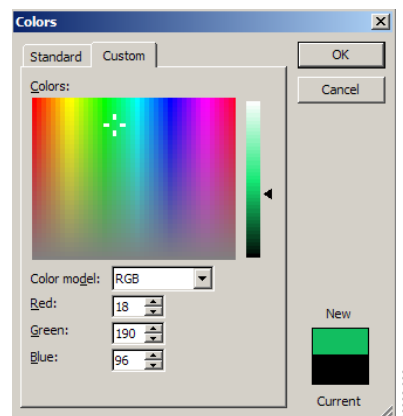

Figure 32. Standard RGB Color Generator

The example in Figure 32 shows a color of green, which is generated with a red content of 18 (out of 255), a green content of 190, and a blue content of 96. All numbers are out of a maximum of 255. Thus, the percentage of red is 7.1%, the percentage of green is 74.5%, and the percentage of blue is 37.6%. To generate the color with the ADP8863, scale this value to each of the current drivers.

AUTOMATED RGB COLOR FADES

The ADP8863 is easily programmed to cycle through RGB generated colors. This can be either a repeating or a random pattern of one color fading into the other. To execute this cycle autonomously, set up the RGB LEDs as described in the RGB Color Generation section and program the on, off, fading times, and current intensities. Adjusting the fading time in particular can create any pattern from a fast, striking effect to a soothing slow color change.

BACKLIGHT OPERATING LEVELS

Backlight brightness control operates at three distinct levels: daylight (L1), office (L2), and dark (L3). The BLV bits in Register 0x04 control the specific level at which the backlight operates. These bits can be changed manually or, if in automatic mode (CMP_AUTOEN is set high in Register 0x01), by the ambient light sensor (see the Ambient Light Sensing section).

By default, the backlight operates at daylight level (BLV = 00), where the maximum brightness is set using Register 0x09 (BLMX1). A daylight dim setting can also be set using Register 0x0A (BLDM1). When operating at office level (BLV = 01), the backlight maximum and dim brightness settings are set using Register 0x0B (BLMX2) and Register 0x0C (BLDM2). When operating at the dark level (BLV = 10), the backlight maximum and dim brightness settings are set using Register 0x0D (BLMX3) and Register 0x0E (BLDM3).

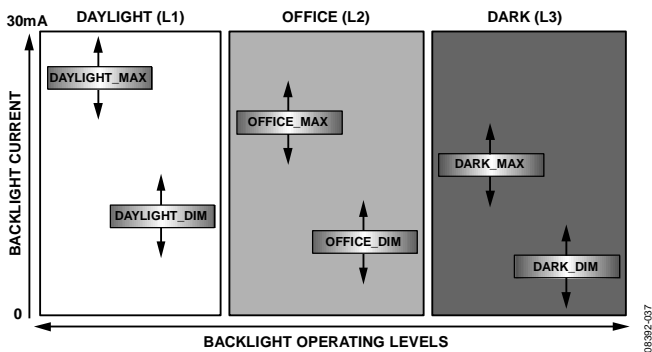

Figure 33. Backlight Operating Levels

BACKLIGHT TURN ON/TURN OFF/DIM

With the device in active mode (nSTBY = 1), the backlight can be turned on using the BL_EN bit in Register 0x01. Before turning on the backlight, select the level (daylight (L1), office (L2), or dark (L3)) to operate in and ensure that maximum and dim settings are programmed for that level. The backlight turns on when BL_EN = 1. The backlight turns off when BL_EN = 0.

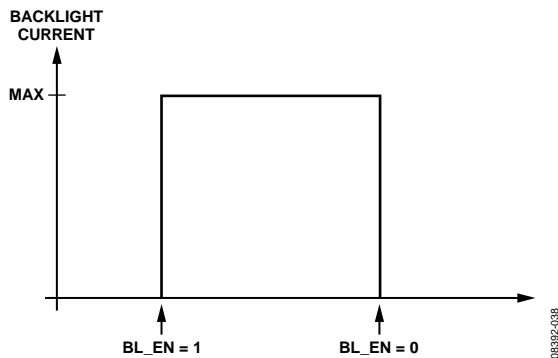

Figure 34. Backlight Turn On/Turn Off

While the backlight is on (BL_EN = 1), the user can change to the dim setting by programming DIM_EN = 1 in Register 0x01. If DIM_EN = 0, the backlight reverts to its maximum setting.

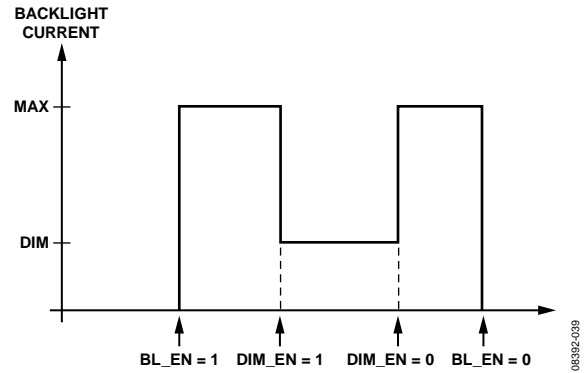

Figure 35. Backlight Turn On/Dim/Turn Off

The maximum and dim settings can be set from 0 mA to 30 mA; therefore, it is possible to program a dim setting that is greater than a maximum setting. For normal expected operation, ensure that the dim setting is programmed to be less than the maximum setting.

AUTOMATIC DIM AND TURN OFF TIMERS

The user can program the backlight to dim automatically by using the DIMT bits in Register 0x07. The dim timer has 127 settings ranging from 1 sec to 127 sec. Program the dim timer (DIMT) before turning on the backlight. If BL_EN = 1, the backlight turns on to its maximum setting and the dim timer starts counting. When the dim timer expires, the internal state machine sets DIM_EN = 1, and the backlight enters its dim setting.

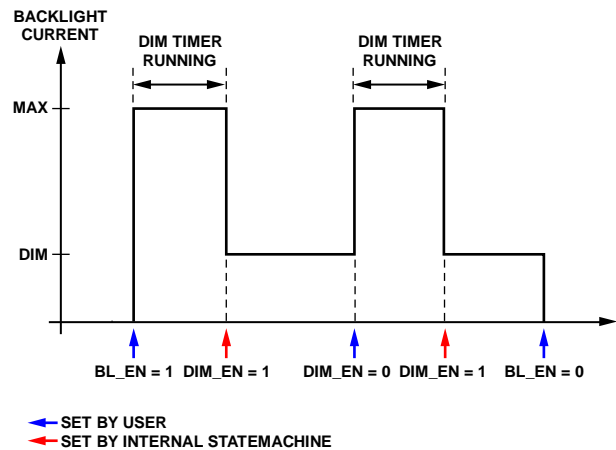

Figure 36. Dim Timer

If the user clears the DIM_EN bit, the backlight reverts to its maximum setting and the dim timer begins counting again. When the dim timer expires, the internal state machine again sets DIM_EN = 1, and the backlight enters its dim setting. The backlight can be turned off at any point during the dim timer countdown by clearing BL_EN.

The user can also program the backlight to turn off automatically by using the OFFT bits in Register 0x06. The off timer has 127 settings ranging from 1 sec to 127 sec. Program the off timer (OFFT) before turning on the backlight. If BL_EN = 1, the backlight turns on to its maximum setting and the off timer

starts counting. When the off timer expires, the internal state machine clears the BL_EN bit, and the backlight turns off.

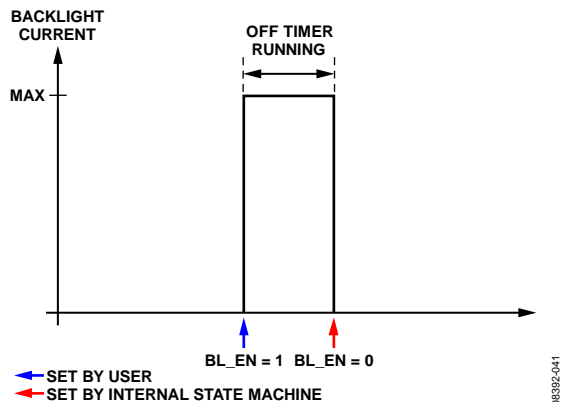

Figure 37. Off Timer

The backlight can be turned off at any point during the off timer countdown by clearing BL_EN.

The dim timer and off timer can be used together for sequential maximum-to-dim-to-off functionality. With both the dim and off timers programmed, and BL_EN asserted, the backlight turns on to its maximum setting, and when the dim timer expires, the backlight changes to its dim setting. When the off timer expires, the backlight turns off.

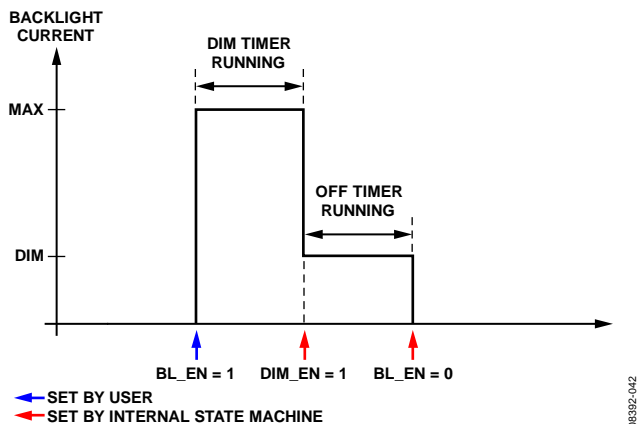

Figure 38. Dim and Off Timers Used Together

FADE OVERRIDE

A fade override feature (FOVR in Register CFGR (0x04)) enables the host to override the preprogrammed fade in or fade out settings. If FOVR is set and the backlight is enabled in the middle of a fade out process, the backlight instantly (within approximately 100 ms) returns to its maximum setting. Alternatively, if the backlight is fading in, reasserting BL_EN overrides the programmed fade in time, and the backlight instantly goes to its final fade value. This is useful for situations in which a key is pressed during a fade sequence. However, if FOVR is cleared and the backlight is enabled in the middle of a fade process, the backlight gradually brightens from where it was interrupted (it does not go down to 0 and then comes back on).

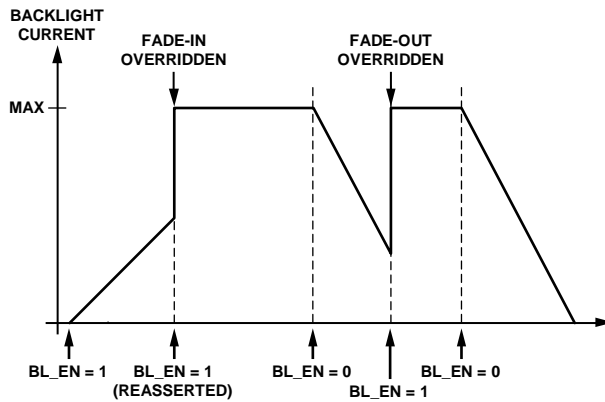

Figure 39. Fade Override Function (FOVR Is High)

AMBIENT LIGHT SENSING

The ADP8863 integrates two ambient light sensing comparators. One of the ambient light sensing comparator pins (CMP_IN) is always available. The second pin (D6) has an ambient light sensor comparator (CMP_IN2) that can be activated rather than connecting an LED to D6. Activating the CMP_IN2 function of the pin is accomplished through the CMP2_SEL bit in Register CFGR. Therefore, when the CMP2_SEL bit is set to 0, Pin D6 is programmed as a current sink. When the CMP2_SEL bit is set to 1, Pin D6 becomes the input for a second phototransistor.

These comparators have two programmable trip points (L2 and L3) that select one of the three backlight operation modes (daylight, office, and dark) based on the ambient lighting conditions.

The L3 comparator controls the dark-to-office mode transition. The L2 comparator controls the office-to-daylight transition (see Figure 40). The currents for the different lighting modes are defined in the BLMXx and BLDMx registers (see the Backlight Operating Levels Section).

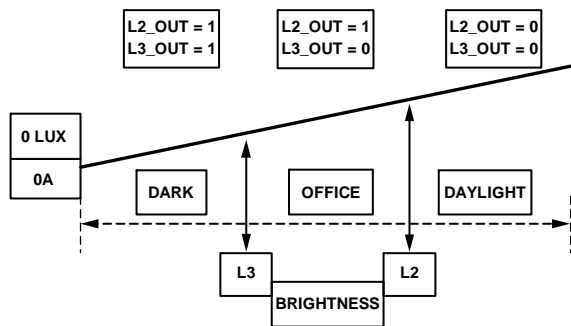

Figure 40. Light Sensor Modes Based on the Detected Ambient Light Level

Each light sensor comparator uses an external capacitor together with an internal reference current source to form an analog-to-digital converter (ADC) that samples the output of the external photosensor. The ADC result is fed into two programmable trip comparators. The ADC has an input range of 0 μ A to 1080 μ A (typical).

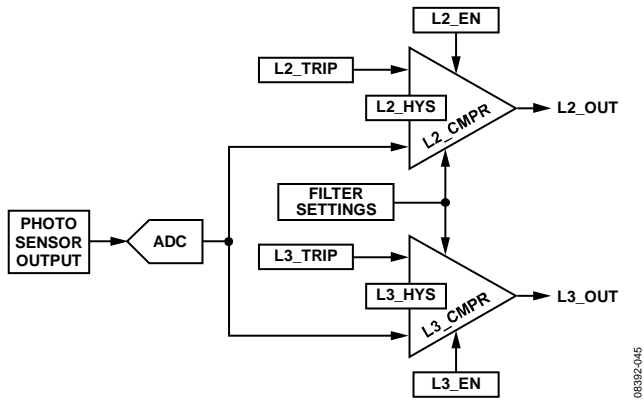

Figure 41. Ambient Light Sensing and Trip Comparators

The L2 comparator, L2_CMPR, detects when the photosensor output has dropped below the programmable L2_TRP point (Register 0x1D). If this event occurs, then the L2_OUT status signal is set. L2_CMPR contains programmable hysteresis, meaning that the photosensor output must rise above L2_TRP + L2_HYS before L2_OUT clears. L2_CMPR is enabled via the L2_EN bit. The L2_TRP and L2_HYS values of L2_CMPR can be set between 0 μ A and 1080 μ A (typical) in steps of 4.3 μ A (typical).

The L3 comparator, L3_CMPR, detects when the photosensor output drops below the programmable L3_TRP point (Register 0x1F). If this event occurs, the L3_OUT status signal is set. L3_CMPR contains programmable hysteresis, meaning that the photosensor output must rise above L3_TRP + L3_HYS before L3_OUT clears. L3_CMPR is enabled via the L3_EN bit. The L3_TRP and L3_HYS values of L3_CMPR can be set between 0 μ A and 137.7 μ A (typical) in steps of 0.54 μ A (typical).

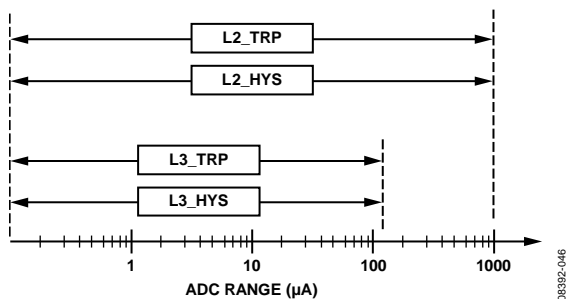

Figure 42. Comparator Ranges

Note that the full-scale value of the L2_TRP and L2_HYS registers is 250 (decimal). Therefore, if the value of L2_TRP + L2_HYS exceeds 250, the comparator output is unable to deassert. For example, if L2_TRP is set to 204 (80% of the full-scale value, or approximately $0.80 \times 1080 \mu\text{A} = 864 \mu\text{A}$), then L2_HYS must be set to less than 46 ($250 - 204 = 46$). If it is not, then L2_HYS + L2_TRP exceeds 250 and the L2_CMPR comparator is never allowed to go low.

When both phototransistors are enabled and programmed in automatic mode (through Bit CMP_AUTOEN in Register 0x01), the user application must determine which comparator outputs to use, by selecting Bit SEL_AB in Register 0x04 for automatic light sensing transitions. For example, the user soft-

ware may select the comparator of the phototransistor that is exposed to higher light intensity to control the transition between the programmed backlight intensity levels.

The L2_CMPR and L3_CMPR comparators can be enabled independently of each other, or they can operate simultaneously. A single conversion from each ADC takes 80 ms (typical). When CMP_AUTOEN is set for automatic backlight adjustment (see the Automatic Backlight Adjustment section), the ADC and comparators run continuously. If the backlight is disabled and at least one independent sink is enabled, it is possible to use the light sensor comparators in a single-shot mode. A single-shot read of the photocomparators is performed by setting the FORCE_RD bit in Register 0x1B. After the single-shot measurement is completed, the internal state machine clears the FORCE_RD bit.

The interrupt flags (CMP_INT and CMP_INT2) can be used to notify the system when either L2 or L3 changes state. See the Interrupts section for more information.

AUTOMATIC BACKLIGHT ADJUSTMENT

The ambient light sensor comparators can automatically transition the backlight between one of its three operating levels. To enable this mode, set the CMP_AUTOEN bit in Register 0x01.

When I²C selection is enabled, the internal state machine takes control of the BLV bits and changes them based on the L2_OUT and L3_OUT status bits. When L2_OUT is set high, it indicates that the ambient light conditions have dropped below the L2_TRP point and that the backlight should move to its office (L2) level. When L3_OUT is set high, it indicates that ambient light conditions have dropped below the L3_TRP point and that the backlight should move to its dark (L3) level. Table 6 shows the relationship between backlight operation and the ambient light sensor comparator outputs.

The L3_OUT status bit has greater priority; therefore, if L3_OUT is set, the backlight operates at L3 (dark) even if L2_OUT is also set.

Filter times from 80 ms to 10 sec can be programmed for the comparators (Register 0x1B and Register 0x1C) before they change state.

Table 6. Comparator Output Truth Table

CMP_AUTOEN	L3_OUT	L2_OUT	Backlight Operation
0	X ¹	X ¹	BLV can be manually set by the user
1	0	0	BLV = 00, backlight operates at L1 (daylight)
1	0	1	BLV = 01, backlight operates at L2 (office)
1	1	X ¹	BLV = 10, backlight operates at L3 (dark)

¹ X is the don't care bit.

USING THE ADP8863 TO DRIVE ADDITIONAL LEDs

In some situations, it may be desirable to drive more than seven LEDs. This can be done in one of two ways: paralleling LEDs using ballast resistors, or using the ADP8863 to power additional LED drivers.

Ballast Resistors

In the first method, multiple LEDs can be attached to any one LED driver with the use of ballast resistors.

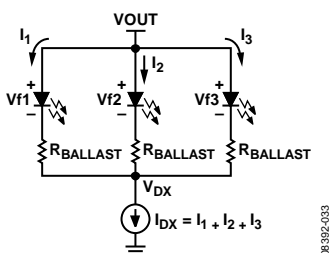

Figure 43. Ballast Resistor Arrangement

Ballast resistors attempt to compensate for the forward voltage (V_f) mismatch inherent in any parallel combination of LEDs. The choice of a ballasting resistor is a trade-off between the efficiency and the current matching of the LEDs in parallel. Smaller ballast resistors give better efficiency. Larger ballast resistors gives better current matching, because the resistor balances out the current differences for a voltage drop. The relationship is summarized with the following:

$$R_{BALLAST} \approx \frac{\Delta V_f}{\Delta I} \tag{5}$$

where:

ΔV_f is the difference between the maximum V_f and the minimum V_f of the LEDs in parallel.

ΔI is the difference between the parallel LED currents.

The addition of the ballast resistor brings the effective V_f of the LED to

$$V_f(\text{eff}) = V_f(\text{LED}) + I_{LED} \times R_{BALLAST} \tag{6}$$

The $I_{LED} \times R_{BALLAST}$ term forces the charge pump to work a little harder for this additional voltage drop. Furthermore, for guaranteed operation with the ADP8863, the total $V_f(\text{eff})$ should never exceed $V_{OUT(\text{REG})} - V_{HR(\text{UP})}$ (see Table 1).

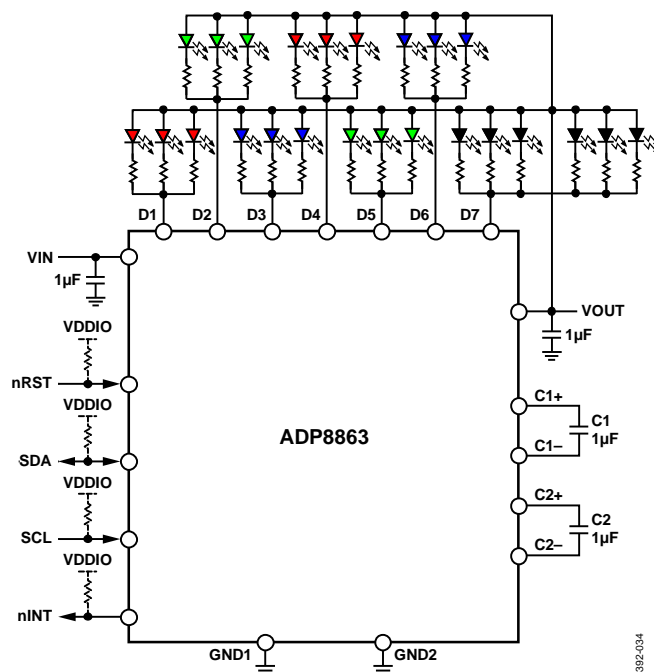

Figure 44. Powering Additional LEDs with Ballast Resistors

Adding Additional Parallel Sinks

The ballast resistor's compromises of efficiency and matching are not suitable for many applications. Therefore, another option is to use the ADP8863 charge pump to power additional current sinks. First, the charge pump must be optimized for this option by setting the GDWN_DIS bit in Register 0x01, which prevents the charge pump from switching back down in gain, and thus stabilizes it against the unknown loads that the additional current sinks present.

To use the sinks, turn the ADP8863 charge pump on before activating the additional sinks. If the additional sinks are activated first, the ADP8863 soft start may not complete.

The ADP8863 can be set up with an ADP8860 or ADP8861. An example using the ADP8861 is shown in Figure 45.

ADP8863

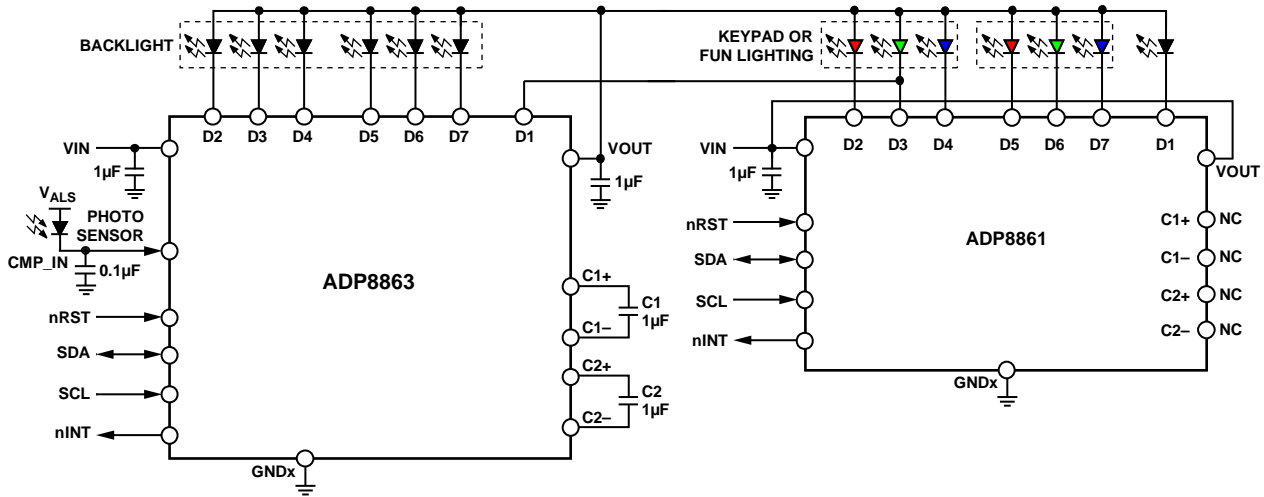

Figure 45. Connecting the ADP8863 to an ADP8861 to Power More LEDs

08392-047

OPERATING LEDs FROM ALTERNATIVE SUPPLIES

For some applications, it is advantageous to operate the LEDs from a voltage source other than the ADP8863 charge pump output. For example, it may be possible to operate a red LED over the entire battery voltage range without any charge pump boosting. For a charge pump,

$$I_{IN} = Gain \times I_{OUT} \quad (7)$$

Therefore, operating the red LEDs directly from the battery removes output current of the red LEDs from the charge pump draw. This in turn reduces the total input current by $(Gain - 1) \times I_{OUT(red)}$.

However, care must be taken when selecting LEDs to operate from a different voltage input. Specifically, the voltage source must at least be able to support the maximum forward voltage (V_f) of the LED plus the maximum $V_{HR(UP)}$ (276 mV, given in Table 1). Additionally, operating an LED from an independent voltage source may interfere with the ADP8863's gain selection algorithm. This algorithm selects the optimal gain for the charge pump based on all seven diodes. By operating one or more of the diodes from another supply, the algorithm may not switch the gain back down to a lower state until the LEDs are disabled or the part enters standby.

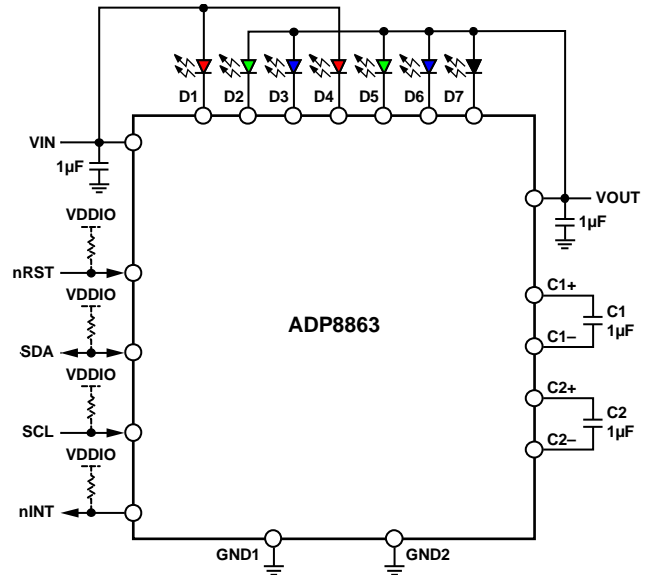

Figure 46. Alternate Schematic for Low Vf LEDs

08392-039

SHORT-CIRCUIT PROTECTION MODE

The ADP8863 can protect against short circuits on the output (V_{OUT}). Short-circuit protection (SCP) is activated at the point when $V_{OUT} < 55\%$ of V_{IN} . Note that SCP sensing is disabled during both startup and restart attempts (fault recovery). SCP sensing is reenabled 4 ms (typical) after activation. During a short-circuit fault, the device enters a low current consumption state and an interrupt flag is set. The device can be restarted at any time after receiving a short-circuit fault by rewriting $nSTBY = 1$. It then repeats another complete soft start sequence. Note that the value of the output capacitance (C_{OUT}) should be small enough to allow V_{OUT} to reach approximately 55% (typical) of V_{IN} within the 4 ms (typical) time. If C_{OUT} is too large, the device inadvertently enters short-circuit protection.

OVERVOLTAGE PROTECTION

Overvoltage protection (OVP) is implemented on the output. There are two types of overvoltage events: normal (no fault) and abnormal (from a fault or sudden load change).

Normal Overvoltage

In a normal (no fault) overvoltage, the output voltage approaches $V_{OUT(REG)}$ (4.9 V typical) during normal operation. This is not caused by a fault or load change, but is simply a consequence of the input voltage times the gain reaching the same level as the clamped output voltage ($V_{OUT(REG)}$). To prevent this type of overvoltage, the ADP8863 detects when the output voltage rises to $V_{OUT(REG)}$. It then increases the effective R_{OUT} of the gain stage to reduce the voltage that is delivered. This effectively regulates V_{OUT} to $V_{OUT(REG)}$; however, there is a limit to the effect that this system can have on regulating V_{OUT} . It is designed only for normal operation and it is not intended to protect against faults or sudden load changes. When the output voltage is regulated to $V_{OUT(REG)}$, no interrupt is set and the operation is transparent to the LEDs and the overall application.

Abnormal Overvoltage

Because of the open-loop behavior of the charge pump as well as how the gain transitions are computed, a sudden load change or fault can abnormally force V_{OUT} beyond 6 V. This causes an abnormal overvoltage situation. If the event happens slowly enough, the system first tries to regulate the output to 4.9 V as in a normal overvoltage scenario. However, if this is not sufficient, or if the event happens too quickly, the ADP8863 enters overvoltage protection (OVP) mode when V_{OUT} exceeds the OVP threshold (typically 5.8 V). In OVP mode, only the charge pump is disabled to prevent V_{OUT} from rising too high. The

current sources and all other device functionality remain intact. When the output voltage falls by about 500 mV (to 5.3 V typical), the charge pump resumes operation. If the fault or load event recurs, the process may repeat. An interrupt flag is set at each OVP instance.

THERMAL SHUTDOWN/OVERTEMPERATURE PROTECTION

If the die temperature of the ADP8863 rises above a safe limit (150°C typical), the controllers enter thermal shutdown (TSD) protection mode. In this mode, most of the internal functions shut down, the part enters standby, and the TSD_INT interrupt (Register 0x02) is set. When the die temperature decreases below ~130°C, the part can be restarted. To restart the part, remove it from standby. No interrupt is generated when the die temperature falls below 130°C. However, if the software clears the pending TSD_INT interrupt and the temperature remains above 130°C, another interrupt is generated.

The complete state machine for these faults (SCP, OVP, and TSD) is shown in Figure 47.

INTERRUPTS

There are five interrupt sources available on the ADP8863 in Register 0x02.

- Main light sensor comparator: The CMP_INT interrupt sets every time the main light sensor comparator detects a threshold (L2 or L3) transition (rising or falling condition).
- Sensor Comparator 2: The CMP2_INT interrupt works the same way as CMP_INT, except that the sensing input derives from the second light sensor. The programmable thresh-olds are the same as for the main light sensor comparator.
- Overvoltage protection: OVP_INT is generated when the output voltage exceeds 5.8 V (typical).
- Thermal shutdown circuit: an interrupt (TSD_INT) is generated when entering overtemperature protection.
- Short-circuit detection: SHORT_INT is generated when the device enters short-circuit protection mode.

The interrupt (if any) that appears on the nINT pin is determined by the bits mapped in Register INTR_EN (0x03). To clear an interrupt, write a 1 to the interrupt in the MDCR2 register (0x02) or reset the part. Reading the interrupt, or writing a 0, has no effect.

APPLICATIONS INFORMATION

The ADP8863 allows the charge pump to operate efficiently with a minimum of external components. Specifically, the user must select an input capacitor (C_{IN}), output capacitor (C_{OUT}), and two charge pump fly capacitors ($C1$ and $C2$). C_{IN} should be $1\ \mu\text{F}$ or greater. The value must be high enough to produce a stable input voltage signal at the minimum input voltage and maximum output load. A $1\ \mu\text{F}$ capacitor for C_{OUT} is recommended. Larger values are permissible, but care must be exercised to ensure that V_{OUT} charges above 55% (typical) of V_{IN} within 4 ms (typical). See the Short-Circuit Protection Mode section for more details.

For best practice, it is recommended that the two charge pump fly capacitors be $1\ \mu\text{F}$; larger values are not recommended, and smaller values may reduce the ability of the charge pump to deliver maximum current. For optimal efficiency, the charge pump fly capacitors should have low equivalent series resistance (ESR). Low ESR X5R or X7R capacitors are recommended for all four components. The use of fly capacitors sized 0402 and smaller is allowed, but the GDWN_DIS bit in Register 0x01 must be set. Minimum voltage ratings should adhere to the guidelines in Table 7.

Table 7. Capacitor Stress in Each Charge Pump Gain State

Capacitor	Gain = 1x	Gain = 1.5x	Gain = 2x
C_{IN}	V_{IN}	V_{IN}	V_{IN}
C_{OUT}	V_{IN}	$V_{IN} \times 1.5$ (max of 5.5 V)	$V_{IN} \times 2.0$ (max of 5.5 V)
C1	None	$V_{IN}/2$	V_{IN}
C2	None	$V_{IN}/2$	V_{IN}

If one or both ambient light sensor comparator inputs (CMP_IN and D6) are used, a small capacitor ($0.1\ \mu\text{F}$ is recommended) must be connected from the input to ground.

Any color LED can be used if the V_f (forward voltage) is less than 4.1 V. However, using lower V_f LEDs reduces the input power consumption by allowing the charge pump to operate at lower gain states.

The equivalent circuit model for a charge pump is shown in Figure 48.

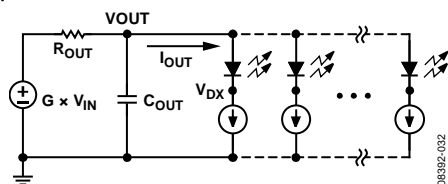

Figure 48. Charge Pump Equivalent Circuit Model

The input voltage is multiplied by the gain (G) and delivered to the output through an effective resistance (R_{OUT}). The output current flows through R_{OUT} and produces an IR drop to yield

$$V_{OUT} = G \times V_{IN} - I_{OUT} \times R_{OUT}(G) \quad (8)$$

The R_{OUT} term is a combination of the $R_{DS(on)}$ resistance for the switches used in the charge pump and a small resistance that accounts for the effective dynamic charge pump resistance. The R_{OUT} level changes based upon the gain (the configuration of the switches). Typical R_{OUT} values are given in Table 1, Figure 13, and Figure 14. V_{OUT} is also equal to the largest V_f of the LEDs used plus the

voltage drop across the regulating current source. This gives

$$V_{OUT} = V_{f(MAX)} + V_{DX} \quad (9)$$

Combining Equation 8 and Equation 9 gives

$$V_{IN} = (V_{f(MAX)} + V_{DX} + I_{OUT} \times R_{OUT}(G))/G \quad (10)$$

Equation 10 is useful for calculating approximate bounds for the charge pump design.

Determining the Transition Point of the Charge Pump

Consider the following design example, where:

$$V_{f(MAX)} = 3.7\ \text{V}$$

$$I_{OUT} = 140\ \text{mA} \text{ (7 LEDs at } 20\ \text{mA each)}$$

$$R_{OUT}(G = 1.5x) = 3\ \Omega \text{ (obtained from Figure 13)}$$

At the point of a gain transition, $V_{DX} = V_{HR(UP)}$. Table 1 gives the typical value of $V_{HR(UP)}$ as 0.2 V. Therefore, the input voltage level when the gain transitions from 1.5x to 2x is

$$V_{IN} = (3.7\ \text{V} + 0.2\ \text{V} + 140\ \text{mA} \times 3\ \Omega)/1.5 = 2.88\ \text{V}$$

LAYOUT GUIDELINES

Note the following layout guidelines:

- For optimal noise immunity, place the C_{IN} and C_{OUT} capacitors as close as possible to their respective pins. These capacitors should share a short ground trace. If the LEDs are a significant distance from the V_{OUT} pin, another capacitor on V_{OUT} , placed closer to the LEDs, is advisable.
- For optimal efficiency, place the charge pump fly capacitors ($C1$ and $C2$) as close to the part as possible.
- The ADP8863 does not distinguish between power ground and analog ground. Therefore, both ground pins can be connected directly together. It is recommended that these ground pins be connected at the ground for the input and output capacitors.
- The LFCSP package requires the exposed pad to be soldered at the board to the GND1 and/or GND2 pin(s).
- Unused diode pins (Pin D1 to Pin D7) can be connected to ground or to V_{OUT} , or remain floating. However, the unused diode current sinks must be disabled by setting them as independent sinks in Register 0x05 and then disabling them in Register 0x10. If they are not disabled, the charge pump efficiency may suffer.
- If the CMP_IN phototransistor input is not used, it can be connected to ground or remain floating.
- If the interrupt pin (nINT) is not used, connect it to ground or leave it floating. Never connect it to a voltage supply, except through a $\geq 1\ \text{k}\Omega$ series resistor.
- The ADP8863 has an integrated noise filter on the nRST pin. Under normal conditions, it is not necessary to filter the reset line. However, if the part is exposed to an unusually noisy signal, it is beneficial to add a small RC filter or bypass capacitor on this pin. If the nRST pin is not used, it must be pulled well above the $V_{IH(MIN)}$ level (see Table 1). Do not allow the nRST pin to float.

I²C PROGRAMMING AND DIGITAL CONTROL

The ADP8863 provides full software programmability to facilitate its adoption in various product architectures. The I²C address is 0101011x (x = 0 during write, x = 1 during read). Therefore, the write address is 0x56 and the read address is 0x57.

Note the following general behavior of registers:

- All registers are set to their default values during reset or after a UVLO event.
- All registers are read/write unless otherwise specified.
- Unused bits are read as zero.

Table 8 to Table 84 provide register and bit descriptions. The reset value for all bits in the bit map tables is all 0s, except in Table 10 (see Table 10 for its unique reset value). Wherever the acronym N/A appears in the tables, it means not applicable.

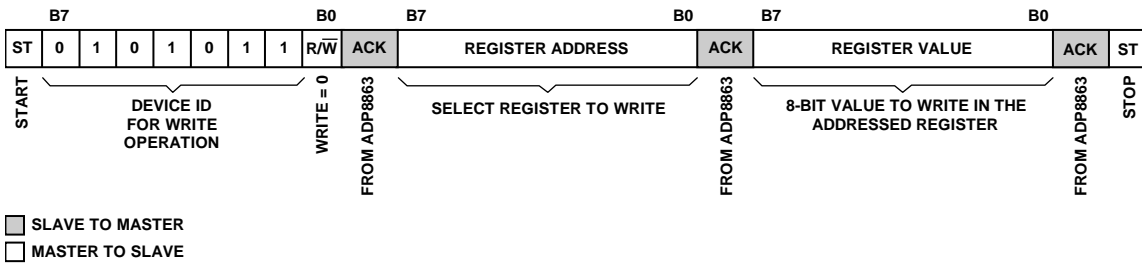

Figure 49. I²C Write Sequence

08392-048

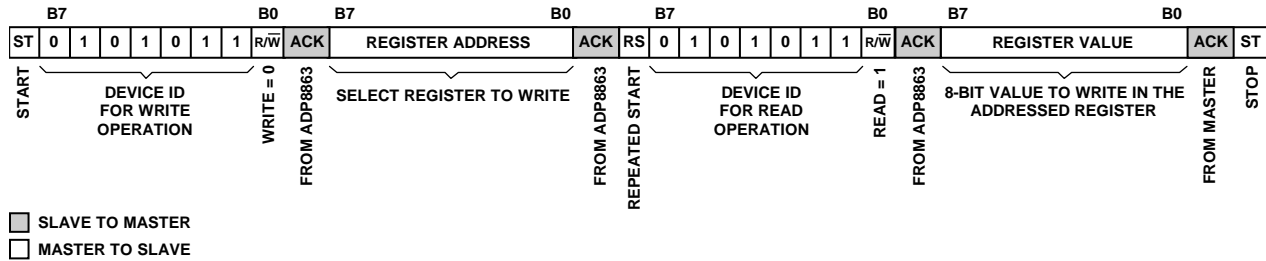

Figure 50. I²C Read Sequence

08392-049

Table 8. Register Set Definitions

Address (Hex)	Register Name	Description
0x00	MFDVID	Manufacturer and device ID
0x01	MDCR	Device mode and status
0x02	MDCR2	Device mode and Status Register 2
0x03	INTR_EN	Interrupts enable
0x04	CFGR	Configuration register
0x05	BLSEN	Sink enable, backlight or independent
0x06	BLOFF	Backlight off timeout
0x07	BLDIM	Backlight dim timeout
0x08	BLFR	Backlight fade in and fade out rates
0x09	BLMX1	Backlight (brightness Level 1—daylight) maximum current
0x0A	BLDM1	Backlight (brightness Level 1—daylight) dim current
0x0B	BLMX2	Backlight (brightness Level 2—office) maximum current
0x0C	BLDM2	Backlight (brightness Level 2—office) dim current
0x0D	BLMX3	Backlight (brightness Level 3—dark) maximum current
0x0E	BLDM3	Backlight (brightness Level 3—dark) dim current
0x0F	ISCFR	Independent sink current fade control register
0x10	ISCC	Independent sink current control register
0x11	ISCT1	Independent sink current timer register, LED[7:5]
0x12	ISCT2	Independent sink current timer register, LED[4:1]
0x13	ISCF	Independent sink current fade register
0x14	ISC7	Independent sink current, LED7
0x15	ISC6	Independent sink current, LED6
0x16	ISC5	Independent sink current, LED5
0x17	ISC4	Independent sink current, LED4
0x18	ISC3	Independent sink current, LED3
0x19	ISC2	Independent sink current, LED2
0x1A	ISC1	Independent sink current, LED1
0x1B	CCFG	Comparator configuration
0x1C	CCFG2	Second comparator configuration
0x1D	L2_TRP	L2 comparator reference
0x1E	L2_HYS	L2 hysteresis
0x1F	L3_TRP	L3 comparator reference
0x20	L3_HYS	L3 hysteresis
0x21	PH1LEVL	First phototransistor ambient light level—low byte register
0x22	PH1LEVH	First phototransistor ambient light level—high byte register
0x23	PH2LEVL	Second phototransistor ambient light level—low byte register
0x24	PH2LEVH	Second phototransistor ambient light level—high byte register

ADP8863

Table 9. Register Map

Addr (Hex)	Reg. Name	Bit 7	Bit 6	Bit 5	Bit 4	Bit 3	Bit 2	Bit 1	Bit 0
0x00	MFDVID	Manufacturer ID				Device ID			
0x01	MDCR	Reserved	INT_CFG	nSTBY	DIM_EN	GDWN_DIS	SIS_EN	CMP_AUTOEN	BL_EN
0x02	MDCR2	Reserved			SHORT_INT	TSD_INT	OVP_INT	CMP2_INT	CMP_INT
0x03	INTR_EN	Reserved			SHORT_IEN	TSD_IEN	OVP_IEN	CMP2_IEN	CMP_IEN
0x04	CFGR	Reserved	SEL_AB	CMP2_SEL	BLV		Law		FOVR
0x05	BLSN	Reserved	D7EN	D6EN	D5EN	D4EN	D3EN	D2EN	D1EN
0x06	BLOFF	Reserved	OFFT						
0x07	BLDIM	Reserved	DIMT						
0x08	BLFR	BL_FO				BL_FI			
0x09	BLMX1	Reserved	BL1_MC						
0x0A	BLDM1	Reserved	BL1_DC						
0x0B	BLMX2	Reserved	BL2_MC						
0x0C	BLDM2	Reserved	BL2_DC						
0x0D	BLMX3	Reserved	BL3_MC						
0x0E	BLDM3	Reserved	BL3_DC						
0x0F	ISCFR	Reserved						SC_LAW	
0x10	ISCC	Reserved	SC7_EN	SC6_EN	SC5_EN	SC4_EN	SC3_EN	SC2_EN	SC1_EN
0x11	ISCT1	SCON		SC7OFF		SC6OFF		SC5OFF	
0x12	ISCT2	SC4OFF		SC3OFF		SC2OFF		SC1OFF	
0x13	ISCF	SCFO				SCFI			
0x14	ISC7	SCR	SCD7						
0x15	ISC6	Reserved	SCD6						
0x16	ISC5	Reserved	SCD5						
0x17	ISC4	Reserved	SCD4						
0x18	ISC3	Reserved	SCD3						
0x19	ISC2	Reserved	SCD2						
0x1A	ISC1	Reserved	SCD1						
0x1B	CCFG	FILT			FORCE_RD	L3_OUT	L2_OUT	L3_EN	L2_EN
0x1C	CCFG2	FILT2			FORCE_RD2	L3_OUT2	L2_OUT2	L3_EN2	L2_EN2
0x1D	L2_TRP	L2_TRP							
0x1E	L2_HYS	L2_HYS							
0x1F	L3_TRP	L3_TRP							
0x20	L3_HYS	L3_HYS							
0x21	PH1LEVL	PH1LEV_LOW							
0x22	PH1LEVH	Reserved				PH1LEV_HIGH			
0x23	PH2LEVL	PH2LEV_LOW							
0x24	PH2LEVH	Reserved				PH2LEV_HIGH			

Manufacturer and Device ID (MFDVID)—Register 0x00

This is a read-only register.

Table 10. MFDVID Bit Map

Bit 7	Bit 6	Bit 5	Bit 4	Bit 3	Bit 2	Bit 1	Bit 0
Manufacturer ID				Device ID			
0	0	1	0	1	0	1	0

Mode Control Register (MDCR)—Register 0x01**Table 11. MDCR Bit Map**

Bit 7	Bit 6	Bit 5	Bit 4	Bit 3	Bit 2	Bit 1	Bit 0
Reserved	INT_CFG	nSTBY	DIM_EN	GDWN_DIS	SIS_EN	CMP_AUTOEN	BL_EN

Table 12. Bit Descriptions for the MDCR Register

Bit Name	Bit No.	Description
N/A	7	Reserved.
INT_CFG	6	Interrupt configuration. 1 = processor interrupt deasserts for 50 μ s and reasserts with pending events. 0 = processor interrupt remains asserted if the host tries to clear the interrupt while there is a pending event.
nSTBY	5	1 = device is in active mode. 0 = device is in standby mode; only the I ² C interface is enabled.
DIM_EN	4	DIM_EN is set by the hardware after a dim timeout. The user may also force the backlight into dim mode by asserting this bit. Dim mode can only be entered if BL_EN is also enabled. 1 = backlight is operating at the dim current level (BL_EN must also be asserted). 0 = backlight is not in dim mode.
GDWN_DIS	3	Gain down disable bit. Setting this bit does not allow the charge pump to switch to lower gains. 1 = the charge pump does not switch down in gain until all LEDs are off. The charge pump switches up in gain as needed. This feature is useful if the ADP8863 charge pump is used to drive an external load. This feature must be used when utilizing small fly capacitors (0402 or smaller). 0 = the charge pump automatically switches up and down in gain. This provides optimal efficiency, but is not suitable for driving loads that are not connected through the ADP8863 diode drivers. Additionally, the charge pump fly capacitors should be low ESR and sized 0603 or greater.
SIS_EN	2	Synchronous independent sinks enable. 1 = enables all LED current sinks designated as independent sinks. All of the ISC enable bits must be cleared; if any of the SCx_EN bits in Register 0x10 are set, this bit has no effect. 0 = disables all sinks designated as independent sinks. All of the ISC enable bits must be cleared; if any of the SCx_EN bits in Register 0x10 are set, this bit has no effect.
CMP_AUTOEN	1	1 = backlight automatically responds to the comparator outputs (L2_OUT and L3_OUT). L2_EN and/or L3_EN must be set for this to function. BLV values in Register 0x04 are overridden. 0 = backlight does not respond automatically to comparator level changes. The user can manually select backlight operating levels using Bit BLV in Register 0x04.
BL_EN	0	1 = backlight is enabled (nSTBY must also be asserted). 0 = backlight is disabled.

ADP8863

Mode Control Register 2 (MDCR2)—Register 0x02

Table 13. MDCR2 Bit Map

Bit 7	Bit 6	Bit 5	Bit 4	Bit 3	Bit 2	Bit 1	Bit 0
Reserved			SHORT_INT	TSD_INT	OVP_INT	CMP2_INT	CMP_INT

Table 14. Bit Descriptions for the MDCR2 Register

Bit Name	Bit No.	Description ¹
N/A	[7:5]	Reserved.
SHORT_INT	4	Short-circuit error interrupt. 1 = a short-circuit or overload condition on VOUT has been detected. 0 = no short-circuit or overload condition has been detected.
TSD_INT	3	Thermal shutdown interrupt. 1 = the device temperature has exceeded 150°C (typical). 0 = no overtemperature condition has been detected.
OVP_INT	2	Overvoltage interrupt. 1 = VOUT has exceeded V _{OVP} . 0 = VOUT has not exceeded V _{OVP} .
CMP2_INT	1	1 = the second ALS comparator (CMP_IN2) has changed state. 0 = the second sensor comparator has not been triggered.
CMP_INT	0	1 = main ALS comparator (CMP_IN) has changed state. 0 = the main sensor comparator has not been triggered.

¹ Interrupt bits are cleared by writing a 1 to the flag; writing a 0 or reading the flag has no effect.

Interrupt Enable (INTR_EN)—Register 0x03

Table 15. INTR_EN Bit Map

Bit 7	Bit 6	Bit 5	Bit 4	Bit 3	Bit 2	Bit 1	Bit 0
Reserved			SHORT_IEN	TSD_IEN	OVP_IEN	CMP2_IEN	CMP_IEN

Table 16. Bit Descriptions for the INTR_EN Register

Bit Name	Bit No.	Description
N/A	[7:5]	Reserved.
SHORT_IEN	4	Short-circuit interrupt is enabled. When the SHORT_INT status bit is set after an error condition, an interrupt is raised to the host if the SHORT_IEN flag is enabled. 1 = the short-circuit interrupt is enabled. 0 = the short-circuit interrupt is disabled (the SHORT_INT flag continues to assert).
TSD_IEN	3	Thermal shutdown interrupt is enabled. When the TSD_INT status bit is set after an error condition, an interrupt is raised to the host if the TSD_IEN flag is enabled. 1 = the thermal shutdown interrupt is enabled. 0 = the thermal shutdown interrupt is disabled (the TSD_INT flag continues to assert).
OVP_IEN	2	Overvoltage interrupt enabled. When the OVP_INT status bit is set after an error condition, an interrupt is raised to the host if the OVP_IEN flag is enabled. 1 = the overvoltage interrupt is enabled. 0 = the overvoltage interrupt is disabled (the OVP_INT flag continues to assert).
CMP2_IEN	1	When the CMP2_INT status bit is set after an enabled comparator trips, an interrupt is raised if the CMP2_IEN flag is enabled. 1 = the second phototransistor comparator interrupt is enabled. 0 = the second phototransistor comparator interrupt is disabled (the CMP2_INT flag continues to assert).
CMP_IEN	0	When the CMP_INT status bit is set after an enabled comparator trips, an interrupt is raised if the CMP_IEN flag is enabled. 1 = the main comparator interrupt is enabled. 0 = the main comparator interrupt is disabled (the CMP_INT flag continues to assert).

BACKLIGHT REGISTER DESCRIPTIONS**Configuration Register (CFGR)—Register 0x04**

Table 17. CFGR Bit Map

Bit 7	Bit 6	Bit 5	Bit 4	Bit 3	Bit 2	Bit 1	Bit 0
Reserved	SEL_AB	CMP2_SEL	BLV		Law		FOVR

Table 18. Bit Descriptions for the CFGR Register

Bit Name	Bit No.	Description
N/A	7	Reserved.
SEL_AB	6	1 = selects the second phototransistor (CMP_IN2) to control the backlight. 0 = selects the main phototransistor (CMP_IN) to control the backlight.
CMP2_SEL	5	1 = the second phototransistor is enabled; the current sink on D6 is disabled. 0 = the second phototransistor is disabled.
BLV	[4:3]	Brightness level. This field indicates the brightness level at which the device is operating. The software may force the backlight to operate at one of the three brightness levels. Setting CMP_AUTOEN high (Register 0x01) sets these values automatically and overwrites any previously written values. 00 = Level 1 (daylight). 01 = Level 2 (office). 10 = Level 3 (dark). 11 = off (backlight set to 0 mA).
Law	[2:1]	Backlight transfer law. 00 = linear law DAC, linear time steps. 01 = square law DAC, linear time steps. 10 = square law DAC, nonlinear time steps (Cubic 10). 11 = square law DAC, nonlinear time steps (Cubic 11).
FOVR	0	Backlight fade override. 1 = the backlight fade override is enabled. 0 = the backlight fade override is disabled.

Backlight Sink Enable (BLSEN)—Register 0x05

Table 19. BLSEN Bit Map

Bit 7	Bit 6	Bit 5	Bit 4	Bit 3	Bit 2	Bit 1	Bit 0
Reserved	D7EN	D6EN	D5EN	D4EN	D3EN	D2EN	D1EN

Table 20. Bit Descriptions for the BLSEN Register

Bit Name	Bit No.	Description
N/A	7	Reserved
D7EN	6	Diode 7 backlight sink enable 1 = selects LED7 as an independent sink 0 = connects LED7 sink to backlight enable (BL_EN)
D6EN	5	Diode 6 backlight sink enable 1 = selects LED6 as an independent sink 0 = connects LED6 sink to backlight enable (BL_EN)
D5EN	4	Diode 5 backlight sink enable 1 = selects LED5 as an independent sink 0 = connects LED5 sink to backlight enable (BL_EN)
D4EN	3	Diode 4 backlight sink enable 1 = selects LED4 as an independent sink 0 = connects LED4 sink to backlight enable (BL_EN)
D3EN	2	Diode 3 backlight sink enable 1 = selects LED3 as an independent sink 0 = connects LED3 sink to backlight enable (BL_EN)

ADP8863

Bit Name	Bit No.	Description
D2EN	1	Diode 2 backlight sink enable 1 = selects LED2 as an independent sink 0 = connects LED2 sink to backlight enable (BL_EN)
D1EN	0	Diode 1 backlight sink enable 1 = selects LED1 as an independent sink 0 = connects LED1 sink to backlight enable (BL_EN)

Backlight Off Timeout (BLOFF)—Register 0x06

Table 21. BLOFF Bit Map

Bit 7	Bit 6	Bit 5	Bit 4	Bit 3	Bit 2	Bit 1	Bit 0
Reserved	OFFT						

Table 22. Bit Descriptions for the BLOFF Register

Bit Name	Bit No.	Description
N/A	7	Reserved.
OFFT	[6:0]	Backlight off timeout. After the off timeout (OFFT) period, the backlight turns off. If the dim timeout (DIMIT) is enabled, the off timeout starts after the dim timeout. 0000000 = timeout disabled 0000001 = 1 sec 0000010 = 2 sec 0000011 = 3 sec ... 1111111 = 127 sec

Backlight Dim Timeout (BLDIM)—Register 0x07

Table 23. BLDIM Bit Map

Bit 7	Bit 6	Bit 5	Bit 4	Bit 3	Bit 2	Bit 1	Bit 0
Reserved	DIMIT						

Table 24. Bit Descriptions for the BLDIM Register

Bit Name	Bit No.	Description
N/A	7	Reserved.
DIMIT	[6:0]	Backlight dim timeout. After the dim timeout (DIMIT) period, the backlight is set to the dim current value. The dim timeout starts after the backlight reaches the maximum current. 0000000 = timeout disabled 0000001 = 1 sec 0000010 = 2 sec 0000011 = 3 sec ... 1111111 = 127 sec

Backlight Fade (BLFR)—Register 0x08**Table 25. BLFR Bit Map**

Bit 7	Bit 6	Bit 5	Bit 4	Bit 3	Bit 2	Bit 1	Bit 0
BL_FO				BL_FI			

Table 26. Bit Descriptions for the BLFR Register

Bit Name	Bit No.	Description
BL_FO	[7:4]	<p>Backlight fade out rate. If fade out is disabled (BL_FO = 0000), the backlight changes instantly (within 100 ms). If the fade out rate is set, the backlight fades from its current value to the dim or the off value. The times listed for BL_FO are for a full-scale fade out (30 mA to 0 mA). Fades between closer current values reduce the fade time. See the Automated Fade In and Fade Out Section for more information.</p> <p>0000 = 0.1 sec (fade out disabled)¹</p> <p>0001 = 0.3 sec</p> <p>0010 = 0.6 sec</p> <p>0011 = 0.9 sec</p> <p>0100 = 1.2 sec</p> <p>0101 = 1.5 sec</p> <p>0110 = 1.8 sec</p> <p>0111 = 2.1 sec</p> <p>1000 = 2.4 sec</p> <p>1001 = 2.7 sec</p> <p>1010 = 3.0 sec</p> <p>1011 = 3.5 sec</p> <p>1100 = 4.0 sec</p> <p>1101 = 4.5 sec</p> <p>1110 = 5.0 sec</p> <p>1111 = 5.5 sec</p>
BL_FI	[3:0]	<p>Backlight fade in rate. If fade in is disabled (BL_FI = 0000), the backlight changes instantly (within 100 ms). If the fade in rate is set, the backlight fades from its current value to its maximum value when the backlight is turned on. The times listed for BL_FI are for a full-scale fade in (0 mA to 30 mA). Fades between closer current values reduce the fade time. See the Automated Fade In and Fade Out Section for more information.</p> <p>0000 = 0.1 sec (fade in disabled)¹</p> <p>0001 = 0.3 sec</p> <p>0010 = 0.6 sec</p> <p>0011 = 0.9 sec</p> <p>...</p> <p>1111 = 5.5 sec</p>

¹ When fade in and fade out are disabled, the backlight does not instantly fade, but instead, fades rapidly within about 100 ms.

ADP8863

Backlight Level 1 (Daylight) Maximum Current Register (BLMX1)—Register 0x09

Table 27. BLMX1 Bit Map

Bit 7	Bit 6	Bit 5	Bit 4	Bit 3	Bit 2	Bit 1	Bit 0
Reserved	BL1_MC						

Table 28. Bit Descriptions for the BLMX1 Register

Bit Name	Bit No.	Description		
N/A	7	Reserved.		
BL1_MC	[6:0]	Backlight Level 1 (daylight) maximum current. The backlight maximum current can be set according to the linear or square law function (see Table 29 for a complete list of values).		
		DAC		
		Linear Law (mA)		
		Square Law (mA)		
		0000000	0	0.000
		0000001	0.236	0.002
0000010	0.472	0.007		
0000011	0.709	0.017		
...		
1111111	30	30		

Table 29. Linear and Square Law Currents Per DAC Code (SCR = 0)

DAC Code	Linear Law (mA)	Square Law (mA) ¹	DAC Code	Linear Law (mA)	Square Law (mA) ¹
0x00	0	0.000	0x22	8.031	2.150
0x01	0.236	0.002	0x23	8.268	2.279
0x02	0.472	0.007	0x24	8.504	2.411
0x03	0.709	0.017	0x25	8.740	2.546
0x04	0.945	0.030	0x26	8.976	2.686
0x05	1.181	0.047	0x27	9.213	2.829
0x06	1.417	0.067	0x28	9.449	2.976
0x07	1.654	0.091	0x29	9.685	3.127
0x08	1.890	0.119	0x2A	9.921	3.281
0x09	2.126	0.151	0x2B	10.157	3.439
0x0A	2.362	0.186	0x2C	10.394	3.601
0x0B	2.598	0.225	0x2D	10.630	3.767
0x0C	2.835	0.268	0x2E	10.866	3.936
0x0D	3.071	0.314	0x2F	11.102	4.109
0x0E	3.307	0.365	0x30	11.339	4.285
0x0F	3.543	0.419	0x31	11.575	4.466
0x10	3.780	0.476	0x32	11.811	4.650
0x11	4.016	0.538	0x33	12.047	4.838
0x12	4.252	0.603	0x34	12.283	5.029
0x13	4.488	0.671	0x35	12.520	5.225
0x14	4.724	0.744	0x36	12.756	5.424
0x15	4.961	0.820	0x37	12.992	5.627
0x16	5.197	0.900	0x38	13.228	5.833
0x17	5.433	0.984	0x39	13.465	6.043
0x18	5.669	1.071	0x3A	13.701	6.257
0x19	5.906	1.163	0x3B	13.937	6.475
0x1A	6.142	1.257	0x3C	14.173	6.696
0x1B	6.378	1.356	0x3D	14.409	6.921
0x1C	6.614	1.458	0x3E	14.646	7.150
0x1D	6.850	1.564	0x3F	14.882	7.382
0x1E	7.087	1.674	0x40	15.118	7.619
0x1F	7.323	1.787	0x41	15.354	7.859
0x20	7.559	1.905	0x42	15.591	8.102
0x21	7.795	2.026	0x43	15.827	8.350

DAC Code	Linear Law (mA)	Square Law (mA) ¹
0x44	16.063	8.601
0x45	16.299	8.855
0x46	16.535	9.114
0x47	16.772	9.376
0x48	17.008	9.642
0x49	17.244	9.912
0x4A	17.480	10.185
0x4B	17.717	10.463
0x4C	17.953	10.743
0x4D	18.189	11.028
0x4E	18.425	11.316
0x4F	18.661	11.608
0x50	18.898	11.904
0x51	19.134	12.203
0x52	19.370	12.507
0x53	19.606	12.814
0x54	19.842	13.124
0x55	20.079	13.439
0x56	20.315	13.757
0x57	20.551	14.078
0x58	20.787	14.404
0x59	21.024	14.733
0x5A	21.260	15.066
0x5B	21.496	15.403
0x5C	21.732	15.743
0x5D	21.968	16.087
0x5E	22.205	16.435
0x5F	22.441	16.787
0x60	22.677	17.142
0x61	22.913	17.501
0x62	23.150	17.863
0x63	23.386	18.230

DAC Code	Linear Law (mA)	Square Law (mA) ¹
0x64	23.622	18.600
0x65	23.858	18.974
0x66	24.094	19.351
0x67	24.331	19.733
0x68	24.567	20.118
0x69	24.803	20.507
0x6A	25.039	20.899
0x6B	25.276	21.295
0x6C	25.512	21.695
0x6D	25.748	22.099
0x6E	25.984	22.506
0x6F	26.220	22.917
0x70	26.457	23.332
0x71	26.693	23.750
0x72	26.929	24.173
0x73	27.165	24.599
0x74	27.402	25.028
0x75	27.638	25.462
0x76	27.874	25.899
0x77	28.110	26.340
0x78	28.346	26.784
0x79	28.583	27.232
0x7A	28.819	27.684
0x7B	29.055	28.140
0x7C	29.291	28.599
0x7D	29.528	29.063
0x7E	29.764	29.529
0x7F	30.000	30.000

¹ Cubic 10 and Cubic 11 laws use the square law DAC setting but vary the time step per DAC code (see the Automated Fade In and Fade Out section).

ADP8863

Backlight Level 1 (Daylight) Dim Current Register (BLDM1)—Register 0x0A

Table 30. BLDM1 Bit Map

Bit 7	Bit 6	Bit 5	Bit 4	Bit 3	Bit 2	Bit 1	Bit 0
Reserved	BL1_DC						

Table 31. Bit Descriptions for the BLDM1 Register

Bit Name	Bit No.	Description
N/A	7	Reserved.
BL1_DC	[6:0]	Backlight Level 1 (daylight) dim current. The backlight is set to the dim current value after a dim timeout or if the DIM_EN flag is set by the user (see Table 29 for a complete list of values).
		DAC
		Linear Law (mA)
		Square Law (mA)
		0000000
0000001	0.236	0.002
0000010	0.472	0.007
0000011	0.709	0.017
...
1111111	30	30

Backlight Level 2 (Office) Maximum Current Register (BLMX2)—Register 0x0B

Table 32. BLMX2 Bit Map

Bit 7	Bit 6	Bit 5	Bit 4	Bit 3	Bit 2	Bit 1	Bit 0
Reserved	BL2_MC						

Table 33. Bit Descriptions for the BLMX2 Register

Bit Name	Bit No.	Description
N/A	7	Reserved.
BL2_MC	[6:0]	Backlight Level 2 (office) maximum current (see Table 29 for a complete list of values).
		DAC
		Linear Law (mA)
		Square Law (mA)
		0000000
0000001	0.236	0.002
0000010	0.472	0.007
0000011	0.709	0.017
...
1111111	30	30

Backlight Level 2 (Office) Dim Current Register (BLDM2)—Register 0x0C

Table 34. BLDM2 Bit Map

Bit 7	Bit 6	Bit 5	Bit 4	Bit 3	Bit 2	Bit 1	Bit 0
Reserved	BL2_DC						

Table 35. Bit Descriptions for the BLDM2 Register

Bit Name	Bit No.	Description		
N/A	7	Reserved.		
BL2_DC	[6:0]	Backlight Level 2 (office) dim current. See Table 29 for a complete list of values. The backlight is set to the dim current value after a dim timeout or if the DIM_EN flag is set by the user.		
		DAC	Linear Law (mA)	Square Law (mA)
		0000000	0	0.000
		0000001	0.236	0.002
		0000010	0.472	0.007
0000011	0.709	0.017		
...		
1111111	30	30		

Backlight Level 3 (Dark) Maximum Current Register (BLMX3)—Register 0x0D

Table 36. BLMX3 Bit Map

Bit 7	Bit 6	Bit 5	Bit 4	Bit 3	Bit 2	Bit 1	Bit 0
Reserved	BL3_MC						

Table 37. Bit Descriptions for the BLMX3 Register

Bit Name	Bit No.	Description		
N/A	7	Reserved.		
BL3_MC	[6:0]	Backlight Level 3 (dark) maximum current. See Table 29 for a complete list of values.		
		DAC	Linear Law (mA)	Square Law (mA)
		0000000	0	0.000
		0000001	0.236	0.002
		0000010	0.472	0.007
0000011	0.709	0.017		
...		
1111111	30	30		

ADP8863

Backlight Level 3 (Dark) Dim Current Register (BLDM3)—Register 0x0E

Table 38. BLDM3 Bit Map

Bit 7	Bit 6	Bit 5	Bit 4	Bit 3	Bit 2	Bit 1	Bit 0
Reserved	BL3_DC						

Table 39. Bit Descriptions for the BLDM3 Register

Bit Name	Bit No.	Description																					
N/A	7	Reserved.																					
BL3_DC	[6:0]	Backlight Level 3 (dark) dim current. See Table 29 for a complete list of values. The backlight is set to the dim current value after a dim timeout or if the DIM_EN flag is set by the user.																					
		<table border="1"> <thead> <tr> <th>DAC</th> <th>Linear Law (mA)</th> <th>Square Law (mA)</th> </tr> </thead> <tbody> <tr> <td>0000000</td> <td>0</td> <td>0.000</td> </tr> <tr> <td>0000001</td> <td>0.236</td> <td>0.002</td> </tr> <tr> <td>0000010</td> <td>0.472</td> <td>0.007</td> </tr> <tr> <td>0000011</td> <td>0.709</td> <td>0.017</td> </tr> <tr> <td>...</td> <td>...</td> <td>...</td> </tr> <tr> <td>1111111</td> <td>30</td> <td>30</td> </tr> </tbody> </table>	DAC	Linear Law (mA)	Square Law (mA)	0000000	0	0.000	0000001	0.236	0.002	0000010	0.472	0.007	0000011	0.709	0.017	1111111	30	30
		DAC	Linear Law (mA)	Square Law (mA)																			
		0000000	0	0.000																			
0000001	0.236	0.002																					
0000010	0.472	0.007																					
0000011	0.709	0.017																					
...																					
1111111	30	30																					

INDEPENDENT SINK REGISTER DESCRIPTIONS

Independent Sink Current Fade Control Register (ISCFR)—Register 0x0F

Table 40. ISCFR Bit Map

Bit 7	Bit 6	Bit 5	Bit 4	Bit 3	Bit 2	Bit 1	Bit 0
Reserved						SC_LAW	

Table 41. Bit Descriptions for the ISCFR Register

Bit Name	Bit No.	Description
N/A	[7:2]	Reserved
SC_LAW	[1:0]	Independent sink current fade transfer law 00 = linear law DAC, linear time steps 01 = square law DAC, linear time steps 10 = square law DAC, nonlinear time steps (Cubic 10) 11 = square law DAC, nonlinear time steps (Cubic 11)

Independent Sink Current Control (ISCC)—Register 0x10

Table 42. ISCC Bit Map

Bit 7	Bit 6	Bit 5	Bit 4	Bit 3	Bit 2	Bit 1	Bit 0
Reserved	SC7_EN	SC6_EN	SC5_EN	SC4_EN	SC3_EN	SC2_EN	SC1_EN

Table 43. Bit Descriptions for the ISCC Register

Bit Name	Bit No.	Description
N/A	7	Reserved
SC7_EN	6	This enable acts upon LED7 1 = SC7 is turned on 0 = SC7 is turned off
SC6_EN	5	This enable acts upon LED6 1 = SC6 is turned on 0 = SC6 is turned off
SC5_EN	4	This enable acts upon LED5 1 = SC5 is turned on 0 = SC5 is turned off

Bit Name	Bit No.	Description
SC4_EN	3	This enable acts upon LED4. 1 = SC4 is turned on. 0 = SC4 is turned off.
SC3_EN	2	This enable acts upon LED3. 1 = SC3 is turned on. 0 = SC3 is turned off.
SC2_EN	1	This enable acts upon LED2. 1 = SC2 is turned on. 0 = SC2 is turned off.
SC1_EN	0	This enable acts upon LED1. 1 = SC1 is turned on. 0 = SC1 is turned off.

Independent Sink Current Time (ISCT1)—Register 0x11

Table 44. ISCT1 Bit Map

Bit 7	Bit 6	Bit 5	Bit 4	Bit 3	Bit 2	Bit 1	Bit 0
SCON		SC7OFF		SC6OFF		SC5OFF	

Table 45. Bit Descriptions for the ISCT1 Register

Bit Name	Bit No.	Description ^{1, 2}
SCON	[7:6]	SC on time. If the SCxOFF time is not disabled and the independent current sink is enabled (Register 0x10), the LED(s) remains on for the time selected (per the following list) and then turns off. 00 = 0.2 sec 01 = 0.6 sec 10 = 0.8 sec 11 = 1.2 sec
SC7OFF	[5:4]	SC7 off time. When the SC off time is disabled, the ISC remains on while enabled. When the SC off time is set to any other value, the ISC turns off for the off time (per the following listed times) and then turns on according to the SCON setting. 00 = off time disabled 01 = 0.6 sec 10 = 1.2 sec 11 = 1.8 sec
SC6OFF	[3:2]	SC6 off time. When the SC off time is disabled, the ISC remains on while enabled. When the SC off time is set to any other value, the ISC turns off for the off time (per the following listed times) and then turns on according to the SCON setting. 00 = off time disabled 01 = 0.6 sec 10 = 1.2 sec 11 = 1.8 sec
SC5OFF	[1:0]	SC5 off time. When the SC off time is disabled, the ISC remains on while enabled. When the SC off time is set to any other value, the ISC turns off for the off time (per the following listed times) and then turns on according to the SCON setting. 00 = off time disabled 01 = 0.6 sec 10 = 1.2 sec 11 = 1.8 sec

¹An independent sink remains on continuously when SCx_EN = 1 and SCxOFF = 00 (disabled).

²To enable multiple independent sinks, set the appropriate SCx_EN bits. To create equivalent blinking and fading sequences, enable all independent sinks in one write cycle to cause a preprogrammed sequence to start simultaneously.

ADP8863

Independent Sink Current Time (ISCT2)—Register 0x12

Table 46. ISCT2 Bit Map

Bit 7	Bit 6	Bit 5	Bit 4	Bit 3	Bit 2	Bit 1	Bit 0
SC4OFF		SC3OFF		SC2OFF		SC1OFF	

Table 47. Bit Descriptions for the ISCT2 Register

Bit Name	Bit No.	Description ^{1, 2}
SC4OFF	[7:6]	SC4 off time. When the SC off time is disabled, the ISC remains on while enabled. When the SC off time is set to any other value, the ISC turns off for the off time (per the following listed times) and then turns on according to the SCON setting. 00 = off time disabled 01 = 0.6 sec 10 = 1.2 sec 11 = 1.8 sec
SC3OFF	[5:4]	SC3 off time. When the SC off time is disabled, the ISC remains on while enabled. When the SC off time is set to any other value, the ISC turns off for the off time (per the following listed times) and then turns on according to the SCON setting. 00 = off time disabled 01 = 0.6 sec 10 = 1.2 sec 11 = 1.8 sec
SC2OFF	[3:2]	SC2 off time. When the SC off time is disabled, the ISC remains on while enabled. When the SC off time is set to any other value, the ISC turns off for the off time (per the following listed times) and then turns on according to the SCON setting. 00 = off time disabled 01 = 0.6 sec 10 = 1.2 sec 11 = 1.8 sec
SC1OFF	[1:0]	SC1 off time. When the SC off time is disabled, the ISC remains on while enabled. When the SC off time is set to any other value, the ISC turns off for the off time (per the following listed times) and then turns on according to the SCON setting. 00 = off time disabled 01 = 0.6 sec 10 = 1.2 sec 11 = 1.8 sec

¹ An independent sink remains on continuously when SCx_EN = 1 and SCxOFF = 00 (disabled).

² To enable multiple independent sinks, set the appropriate SCx_EN bits. To create equivalent blinking and fading sequences, enable all independent sinks in one write cycle. This causes a preprogrammed sequence to start simultaneously.

Independent Sink Current Fade (ISCF)—Register 0x13

Table 48. ISCF Bit Map

Bit 7	Bit 6	Bit 5	Bit 4	Bit 3	Bit 2	Bit 1	Bit 0
SCFO				SCFI			

Table 49. Bit Descriptions for the ISCF Register

Bit Name	Bit No.	Description
SCFO	[7:4]	<p>Sink current fade out rate. The times listed here are for a full-scale fade out (30 mA to 0 mA). Fades between closer current values reduce the fade time. See the Automated Fade In and Fade Out section for more information.</p> <p>0000 = disabled 0001 = 0.30 sec 0010 = 0.60 sec 0011 = 0.90 sec 0100 = 1.2 sec 0101 = 1.5 sec 0110 = 1.8 sec 0111 = 2.1 sec 1000 = 2.4 sec 1001 = 2.7 sec 1010 = 3.0 sec 1011 = 3.5 sec 1100 = 4.0 sec 1101 = 4.5 sec 1110 = 5.0 sec 1111 = 5.5 sec</p>
SCFI	[3:0]	<p>Sink current fade in rate. The times listed here are for a full-scale fade in (0 mA to 30 mA). Fades between closer current values reduce the fade time. See the Automated Fade In and Fade Out section for more information.</p> <p>0000 = disabled 0001 = 0.30 sec 0010 = 0.60 sec 0011 = 0.90 sec 0100 = 1.2 sec 0101 = 1.5 sec 0110 = 1.8 sec 0111 = 2.1 sec 1000 = 2.4 sec 1001 = 2.7 sec 1010 = 3.0 sec 1011 = 3.5 sec 1100 = 4.0 sec 1101 = 4.5 sec 1110 = 5.0 sec 1111 = 5.5 sec</p>

ADP8863

Sink Current Register LED7 (ISC7)—Register 0x14

Table 50. ISC7 Bit Map

Bit 7	Bit 6	Bit 5	Bit 4	Bit 3	Bit 2	Bit 1	Bit 0
SCR	SCD7						

Table 51. Bit Descriptions for the ISC7 Register

Bit Name	Bit No.	Description																					
SCR	7	1 = Sink Current 1. 0 = Sink Current 0.																					
SCD7	[6:0]	For Sink Current 0, use the following DAC code schedule (see Table 29 for a complete list of values).																					
		<table border="1"> <thead> <tr> <th>DAC</th> <th>Linear Law (mA)</th> <th>Square Law (mA)</th> </tr> </thead> <tbody> <tr><td>0000000</td><td>0.000</td><td>0</td></tr> <tr><td>0000001</td><td>0.236</td><td>0.002</td></tr> <tr><td>0000010</td><td>0.472</td><td>0.007</td></tr> <tr><td>0000011</td><td>0.709</td><td>0.017</td></tr> <tr><td>...</td><td>...</td><td>...</td></tr> <tr><td>1111111</td><td>30</td><td>30</td></tr> </tbody> </table>	DAC	Linear Law (mA)	Square Law (mA)	0000000	0.000	0	0000001	0.236	0.002	0000010	0.472	0.007	0000011	0.709	0.017	1111111	30	30
		DAC	Linear Law (mA)	Square Law (mA)																			
		0000000	0.000	0																			
		0000001	0.236	0.002																			
		0000010	0.472	0.007																			
		0000011	0.709	0.017																			
																				
		1111111	30	30																			
		For Sink Current 1, use the following DAC code schedule (see Table 52 for a complete list of values).																					
		<table border="1"> <thead> <tr> <th>DAC</th> <th>Linear Law (mA)</th> <th>Square Law (mA)</th> </tr> </thead> <tbody> <tr><td>0000000</td><td>0.000</td><td>0</td></tr> <tr><td>0000001</td><td>0.472</td><td>0.004</td></tr> <tr><td>0000010</td><td>0.945</td><td>0.014</td></tr> <tr><td>0000011</td><td>1.42</td><td>0.034</td></tr> <tr><td>...</td><td>...</td><td>...</td></tr> <tr><td>1111111</td><td>60</td><td>60</td></tr> </tbody> </table>	DAC	Linear Law (mA)	Square Law (mA)	0000000	0.000	0	0000001	0.472	0.004	0000010	0.945	0.014	0000011	1.42	0.034	1111111	60	60
		DAC	Linear Law (mA)	Square Law (mA)																			
0000000	0.000	0																					
0000001	0.472	0.004																					
0000010	0.945	0.014																					
0000011	1.42	0.034																					
...																					
1111111	60	60																					

Table 52. Linear and Square Law Currents for LED7 (SCR = 1)

DAC Code	Linear Law (mA)	Square Law (mA) ¹	DAC Code	Linear Law (mA)	Square Law (mA) ¹
0x00	0.000	0	0x18	11.34	2.142
0x01	0.472	0.004	0x19	11.81	2.326
0x02	0.945	0.014	0x1A	12.28	2.514
0x03	1.42	0.034	0x1B	12.76	2.712
0x04	1.89	0.06	0x1C	13.23	2.916
0x05	2.36	0.094	0x1D	13.70	3.128
0x06	2.83	0.134	0x1E	14.17	3.348
0x07	3.31	0.182	0x1F	14.65	3.574
0x08	3.78	0.238	0x20	15.12	3.81
0x09	4.25	0.302	0x21	15.59	4.052
0x0A	4.72	0.372	0x22	16.06	4.3
0x0B	5.20	0.45	0x23	16.54	4.558
0x0C	5.67	0.536	0x24	17.01	4.822
0x0D	6.14	0.628	0x25	17.48	5.092
0x0E	6.61	0.73	0x26	17.95	5.372
0x0F	7.09	0.838	0x27	18.43	5.658
0x10	7.56	0.952	0x28	18.90	5.952
0x11	8.03	1.076	0x29	19.37	6.254
0x12	8.50	1.206	0x2A	19.84	6.562
0x13	8.98	1.342	0x2B	20.31	6.878
0x14	9.45	1.488	0x2C	20.79	7.202
0x15	9.92	1.64	0x2D	21.26	7.534
0x16	10.39	1.8	0x2E	21.73	7.872
0x17	10.87	1.968	0x2F	22.20	8.218

DAC Code	Linear Law (mA)	Square Law (mA) ¹
0x30	22.68	8.57
0x31	23.15	8.932
0x32	23.62	9.3
0x33	24.09	9.676
0x34	24.57	10.058
0x35	25.04	10.45
0x36	25.51	10.848
0x37	25.98	11.254
0x38	26.46	11.666
0x39	26.93	12.086
0x3A	27.40	12.514
0x3B	27.87	12.95
0x3C	28.35	13.392
0x3D	28.82	13.842
0x3E	29.29	14.3
0x3F	29.76	14.764
0x40	30.24	15.238
0x41	30.71	15.718
0x42	31.18	16.204
0x43	31.65	16.7
0x44	32.13	17.202
0x45	32.60	17.71
0x46	33.07	18.228
0x47	33.54	18.752
0x48	34.02	19.284
0x49	34.49	19.824
0x4A	34.96	20.37
0x4B	35.43	20.926
0x4C	35.91	21.486
0x4D	36.38	22.056
0x4E	36.85	22.632
0x4F	37.32	23.216
0x50	37.80	23.808
0x51	38.27	24.406
0x52	38.74	25.014
0x53	39.21	25.628
0x54	39.69	26.248
0x55	40.16	26.878
0x56	40.63	27.514
0x57	41.10	28.156

DAC Code	Linear Law (mA)	Square Law (mA) ¹
0x58	41.57	28.808
0x59	42.05	29.466
0x5A	42.52	30.132
0x5B	42.99	30.806
0x5C	43.46	31.486
0x5D	43.94	32.174
0x5E	44.41	32.87
0x5F	44.88	33.574
0x60	45.35	34.284
0x61	45.83	35.002
0x62	46.30	35.726
0x63	46.77	36.46
0x64	47.24	37.2
0x65	47.72	37.948
0x66	48.19	38.702
0x67	48.66	39.466
0x68	49.13	40.236
0x69	49.61	41.014
0x6A	50.08	41.798
0x6B	50.55	42.59
0x6C	51.02	43.39
0x6D	51.50	44.198
0x6E	51.97	45.012
0x6F	52.44	45.834
0x70	52.91	46.664
0x71	53.39	47.5
0x72	53.86	48.346
0x73	54.33	49.198
0x74	54.80	50.056
0x75	55.28	50.924
0x76	55.75	51.798
0x77	56.22	52.68
0x78	56.69	53.568
0x79	57.17	54.464
0x7A	57.64	55.368
0x7B	58.11	56.28
0x7C	58.58	57.198
0x7D	59.06	58.126
0x7E	59.53	59.058
0x7F	60	60

¹ Cubic 10 and Cubic 11 laws use the square law DAC setting but vary the time step per DAC code (see the Automated Fade In and Fade Out section).

ADP8863

Sink Current Register LED6 (ISC6)—Register 0x15

Table 53. ISC6 Bit Map

Bit 7	Bit 6	Bit 5	Bit 4	Bit 3	Bit 2	Bit 1	Bit 0
Reserved	SCD6						

Table 54. Bit Descriptions for the ISC6 Register

Bit Name	Bit No.	Description		
N/A	7	Reserved.		
SCD6	[6:0]	Sink current. Use the following DAC code schedule (see Table 29 for a complete list of values).		
		DAC	Linear Law (mA)	Square Law (mA)
		0000000	0	0.000
		0000001	0.236	0.002
		0000010	0.472	0.007
		0000011	0.709	0.017
...		
1111111	30	30		

Sink Current Register LED5 (ISC5)—Register 0x16

Table 55. ISC5 Bit Map

Bit 7	Bit 6	Bit 5	Bit 4	Bit 3	Bit 2	Bit 1	Bit 0
Reserved	SCD5						

Table 56. Bit Descriptions for the ISC5 Register

Bit Name	Bit No.	Description		
N/A	7	Reserved.		
SCD5	[6:0]	Sink current. Use the following DAC code schedule (see Table 29 for a complete list of values).		
		DAC	Linear Law (mA)	Square Law (mA)
		0000000	0	0.000
		0000001	0.236	0.002
		0000010	0.472	0.007
		0000011	0.709	0.017
...		
1111111	30	30		

Sink Current Register LED4 (ISC4)—Register 0x17

Table 57. ISC4 Bit Map

Bit 7	Bit 6	Bit 5	Bit 4	Bit 3	Bit 2	Bit 1	Bit 0
Reserved	SCD4						

Table 58. Bit Descriptions for the ISC4 Register

Bit Name	Bit No.	Description		
N/A	7	Reserved.		
SCD4	[6:0]	Sink current. Use the following DAC code schedule (see Table 29 for a complete list of values):		
		DAC	Linear Law (mA)	Square Law (mA)
		0000000	0	0.000
		0000001	0.236	0.002
		0000010	0.472	0.007
		0000011	0.709	0.017
...		
1111111	30	30		

Sink Current Register LED3 (ISC3)—Register 0x18

Table 59. ISC3 Bit Map

Bit 7	Bit 6	Bit 5	Bit 4	Bit 3	Bit 2	Bit 1	Bit 0
Reserved	SCD3						

Table 60. Bit Descriptions for the ISC3 Register

Bit Name	Bit No.	Description		
N/A	7	Reserved.		
SCD3	[6:0]	Sink current. Use the following DAC code schedule (see Table 29 for a complete list of values).		
		DAC	Linear Law (mA)	Square Law (mA)
		0000000	0	0.000
		0000001	0.236	0.002
		0000010	0.472	0.007
		0000011	0.709	0.017
...		
1111111	30	30		

Sink Current Register LED2 (ISC2)—Register 0x19

Table 61. ISC2 Bit Map

Bit 7	Bit 6	Bit 5	Bit 4	Bit 3	Bit 2	Bit 1	Bit 0
Reserved	SCD2						

Table 62. Bit Descriptions for the ISC2 Register

Bit Name	Bit No.	Description		
N/A	7	Reserved.		
SCD2	[6:0]	Sink current. Use the following DAC code schedule (see Table 29 for a complete list of values).		
		DAC	Linear Law (mA)	Square Law (mA)
		0000000	0	0.000
		0000001	0.236	0.002
		0000010	0.472	0.007
		0000011	0.709	0.017
...		
1111111	30	30		

Sink Current Register LED1 (ISC1)—Register 0x1A

Table 63. ISC1 Bit Map

Bit 7	Bit 6	Bit 5	Bit 4	Bit 3	Bit 2	Bit 1	Bit 0
Reserved	SCD1						

Table 64. Bit Descriptions for the ISC1 Register

Bit Name	Bit No.	Description		
N/A	7	Reserved.		
SCD1	[6:0]	Sink current. Use the following DAC code schedule (see Table 29 for a complete list of values).		
		DAC	Linear Law (mA)	Square Law (mA)
		0000000	0	0.000
		0000001	0.236	0.002
		0000010	0.472	0.007
		0000011	0.709	0.017
...		
1111111	30	30		

ADP8863

COMPARATOR REGISTER DESCRIPTIONS

Comparator Configuration (CCFG)—Register 0x1B

Table 65. CCFG Bit Map

Bit 7	Bit 6	Bit 5	Bit 4	Bit 3	Bit 2	Bit 1	Bit 0
FILT			FORCE_RD	L3_OUT	L2_OUT	L3_EN	L2_EN

Table 66. Bit Descriptions for the CCFG Register

Bit Name	Bit No.	Description
FILT	[7:5]	Filter setting for the CMP_IN light sensor. 000 = 80 ms 001 = 160 ms 010 = 320 ms 011 = 640 ms 100 = 1280 ms 101 = 2560 ms 110 = 5120 ms 111 = 10,240 ms
FORCE_RD	4	Force a read of the CMP_IN light sensor while independent sinks are running, but the backlight is not. Reset by chip after the conversion is complete and L2_OUT and L3_OUT are valid. Ignored if the backlight is enabled.
L3_OUT	3	This bit is the output of the L3 comparator.
L2_OUT	2	This bit is the output of the L2 comparator.
L3_EN	1	1 = the L3 comparator is enabled for the CMP_IN comparator. 0 = the L3 comparator is disabled for the CMP_IN comparator.
L2_EN	0	Note that the L3 comparator has priority over the L2 comparator. 1 = the L2 comparator is enabled for the CMP_IN comparator. 0 = the L2 comparator is disabled for the CMP_IN comparator.

Second Comparator Configuration (CCFG2)—Register 0x1C

Table 67. CCFG2 Bit Map

Bit 7	Bit 6	Bit 5	Bit 4	Bit 3	Bit 2	Bit 1	Bit 0
FILT2			FORCE_RD2	L3_OUT2	L2_OUT2	L3_EN2	L2_EN2

Table 68. Bit Descriptions for the CCFG2 Register

Bit Name	Bit No.	Description
FILT2	[7:5]	Filter setting for the CMP_IN2 light sensor. 000 = 80 ms 001 = 160 ms 010 = 320 ms 011 = 640 ms 100 = 1280 ms 101 = 2560 ms 110 = 5120 ms 111 = 10,240 ms
FORCE_RD2	4	Force a read of the CMP_IN2 light sensor while independent sinks are running, but the backlight is not. Reset by chip after the conversion is complete and L2_OUT and L3_OUT are valid. Ignored if backlight is enabled.
L3_OUT2	3	This bit is the output of the L3 comparator for the second light sensor.
L2_OUT2	2	This bit is the output of the L2 comparator for the second light sensor.
L3_EN2	1	1 = the L3 comparator is enabled for the CMP_IN2 comparator. 0 = the L3 comparator is disabled for the CMP_IN2 comparator.
L2_EN2	0	Note that the L3 comparator has priority over the L2 comparator. 1 = the L2 comparator is enabled for the CMP_IN2 comparator. 0 = the L2 comparator is disabled for the CMP_IN2 comparator.

Comparator Level 2 Threshold (L2_TRP)—Register 0x1D

Table 69. L2_TRP Bit Map

Bit 7	Bit 6	Bit 5	Bit 4	Bit 3	Bit 2	Bit 1	Bit 0
L2_TRP							

Table 70. Bit Descriptions for the L2_TRP Register

Bit Name	Bit No.	Description
L2_TRP	[7:0]	<p>Comparator Level 2 threshold. If the comparator input is below L2_TRP, the comparator trips and the backlight enters Level 2 (office) mode. The following lists the code settings for the photosensor current:</p> <p>00000000 = 0 μA 00000001 = 4.3 μA 00000010 = 8.6 μA 00000011 = 12.9 μA ... 11111010 = 1080 μA ... 11111111 = 1106 μA</p> <p>Although codes above 1111010 (250 decimal) are possible, they should not be used. Furthermore, the maximum value of L2_TRP + L2_HYS must not exceed 1111010 (250).</p>

Comparator Level 2 Hysteresis (L2_HYS)—Register 0x1E

Table 71. L2_HYS Bit Map

Bit 7	Bit 6	Bit 5	Bit 4	Bit 3	Bit 2	Bit 1	Bit 0
L2_HYS							

Table 72. Bit Descriptions for the L2_HYS Register

Bit Name	Bit No.	Description
L2_HYS	[7:0]	<p>Comparator Level 2 hysteresis. If the comparator input is above L2_TRP + L2_HYS, the comparator trips and the backlight enters Level 1 (daylight) mode. The following lists the code settings for the photosensor current hysteresis:</p> <p>00000000 = 0 μA 00000001 = 4.3 μA 00000010 = 8.6 μA 00000011 = 12.9 μA ... 11111010 = 1080 μA ... 11111111 = 1106 μA</p> <p>Although codes above 1111010 (250 decimal) are possible, they should not be used. Furthermore, the maximum value of L2_TRP + L2_HYS must not exceed 1111010 (250).</p>

ADP8863

Comparator Level 3 Threshold (L3_TRP)—Register 0x1F

Table 73. L3_TRP Bit Map

Bit 7	Bit 6	Bit 5	Bit 4	Bit 3	Bit 2	Bit 1	Bit 0
L3_TRP							

Table 74. Bit Descriptions for the L3_TRP Register

Bit Name	Bit No.	Description
L3_TRP	7:0	Comparator Level 3 threshold. If the comparator input is below L3_TRP, the comparator trips and the backlight enters Level 3 (dark) mode. The following lists the code settings for photosensor current: 00000000 = 0 μ A 00000001 = 0.54 μ A 00000010 = 1.08 μ A 00000011 = 1.62 μ A ... 11111111 = 137.7 μ A

Comparator Level 3 Hysteresis (L3_HYS)—Register 0x20

Table 75. L3_HYS Bit Map

Bit 7	Bit 6	Bit 5	Bit 4	Bit 3	Bit 2	Bit 1	Bit 0
L3_HYS							

Table 76. Bit Descriptions for the L3_HYS Register

Bit Name	Bit No.	Description
L3_HYS	[7:0]	Comparator Level 3 hysteresis. If the comparator input is above L3_TRP + L3_HYS, the comparator trips and the backlight enters Level 2 (office) mode. The following lists the code settings for photosensor current hysteresis: 00000000 = 0 μ A 00000001 = 0.54 μ A 00000010 = 1.08 μ A 00000011 = 1.62 μ A ... 11111111 = 137.7 μ A

First Phototransistor Register: Low Byte (PH1LEVL)—Register 0x21

Table 77. PH1LEVL Bit Map

Bit 7	Bit 6	Bit 5	Bit 4	Bit 3	Bit 2	Bit 1	Bit 0
PH1LEV_LOW							

Table 78. Bit Descriptions for the PH1LEVL Register

Bit Name	Bit No.	Description
PH1LEV_LOW	[7:0]	Lower eight bits of the 13-bit conversion value for the first light sensor (Bit 7 to Bit 0). The value is updated every 80 ms (when the light sensor is enabled). This is a read-only register.

First Phototransistor Register: High Byte (PH1LEVH)—Register 0x22

Table 79. PH1LEVH Bit Map

Bit 7	Bit 6	Bit 5	Bit 4	Bit 3	Bit 2	Bit 1	Bit 0
Reserved				PH1LEV_HIGH			

Table 80. Bit Descriptions for the PH1LEVH Register

Bit Name	Bit No.	Description
N/A	[7:5]	Reserved.
PH1LEV_HIGH	[4:0]	Upper five bits of the 13-bit conversion value for the first light sensor (Bit 12 to Bit 8). The value is updated every 80 ms (when the light sensor is enabled). This is a read-only register.

Second Phototransistor Register: Low Byte (PH2LEVL)—Register 0x23

Table 81. PH2LEVL Bit Map

Bit 7	Bit 6	Bit 5	Bit 4	Bit 3	Bit 2	Bit 1	Bit 0
PH2LEV_LOW							

Table 82. Bit Descriptions for the PH2LEVL Register

Bit Name	Bit No.	Description
PH2LEV_LOW	[7:0]	Lower eight bits of the 13-bit conversion value for the second light sensor (Bit 7 to Bit 0). The value is updated every 80 ms (when the light sensor is enabled). This is a read-only register.

Second Phototransistor Register: High Byte (PH2LEVH)—Register 0x24

Table 83. PH2LEVH Bit Map

Bit 7	Bit 6	Bit 5	Bit 4	Bit 3	Bit 2	Bit 1	Bit 0
Reserved				PH2LEV_HIGH			

Table 84. Bit Descriptions for the PH2LEVH Register

Bit Name	Bit No.	Description
N/A	[7:5]	Reserved
PH2LEV_HIGH	[4:0]	Upper five bits of the 13-bit conversion value for the second light sensor (Bit 12 to Bit 8). The value is updated every 80 ms (when the light sensor is enabled). This is a read-only register.

OUTLINE DIMENSIONS

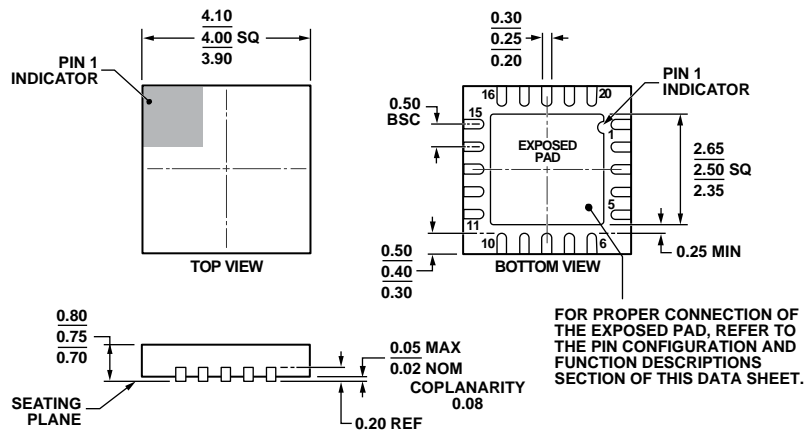

COMPLIANT TO JEDEC STANDARDS MO-220-WGGD.

Figure 51. 20-Lead Lead Frame Chip Scale Package [LFCSP_WQ]
 4 mm × 4 mm Body, Very Very Thin Quad
 (CP-20-10)
 Dimensions shown in millimeters

061609-B

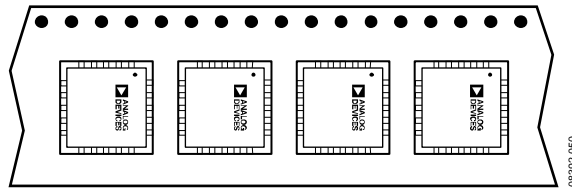

Figure 52. Tape and Reel Orientation for LFCSP Units

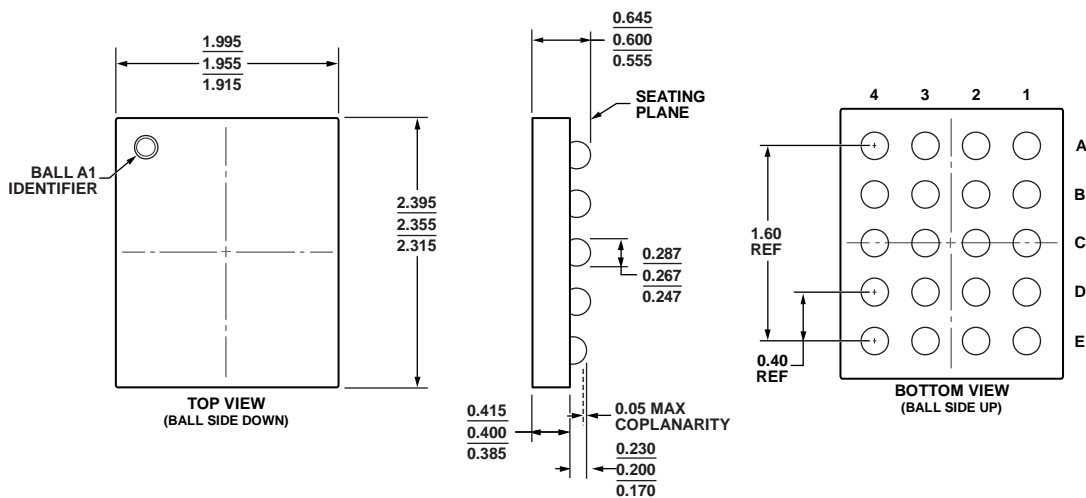

Figure 53. 20-Ball Wafer Level Chip Scale Package [WLCSP] (CB-20-6)
Dimensions shown in millimeters

021009-A

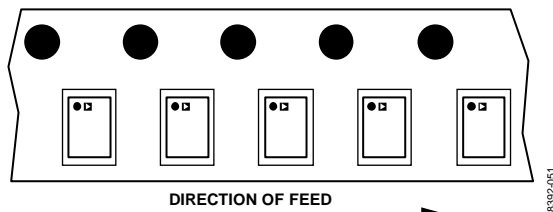

Figure 54. Tape and Reel Orientation for WLCSP Units

ORDERING GUIDE

Model ¹	Temperature Range	Package Description	Package Option
ADP8863ACPZ-R7	-40°C to +85°C	20-Lead LFCSP_WQ, 7" Tape and Reel	CP-20-10
ADP8863ACBZ-R7	-40°C to +85°C	20-Ball WLCSP, 7" Tape and Reel	CB-20-6
ADP8863DBCP-EVALZ		Daughter Card	
ADP886XMB1-EVALZ		USB-to-I ² C Adapter Board	

¹ Z = RoHS Compliant Part.

ADP8863

NOTES

NOTES

NOTES

I²C refers to a communications protocol originally developed by Philips Semiconductors (now NXP Semiconductors).