

## FEATURES

- Specified over temperature
- Low power consumption (5  $\mu$ A typical)
- Precision voltage monitor of voltages from 2.5 V to 5 V at 100 mV increments
- Reset assertion down to  $V_{CC} > 1$  V
- Reset timeout periods: 1 ms, 20 ms, 140 ms, or 1120 ms (minimum)
- Built-in manual reset
- Pin compatible with the ADM811
- Available in SOT-143 package
- Qualified for automotive applications

## APPLICATIONS

- Microprocessor systems
- Controllers
- Intelligent instruments
- Automotive systems
- Safety systems
- Portable instruments

## GENERAL DESCRIPTION

The [ADM6315](#) is a reliable voltage-monitoring device that is suitable for use in most voltage-monitoring applications.

The [ADM6315](#) is designed to monitor as little as a 1.8% degradation of a power supply voltage. The [ADM6315](#) can monitor all voltages (at 100 mV increments) from 2.5 V to 5 V.

Included in this circuit is a debounced manual reset input.  $\overline{\text{RESET}}$  can be activated using an ordinary switch (pulling  $\overline{\text{MR}}$  low), a low input from another digital device, or a degradation of the supply voltage.

## FUNCTIONAL BLOCK DIAGRAM

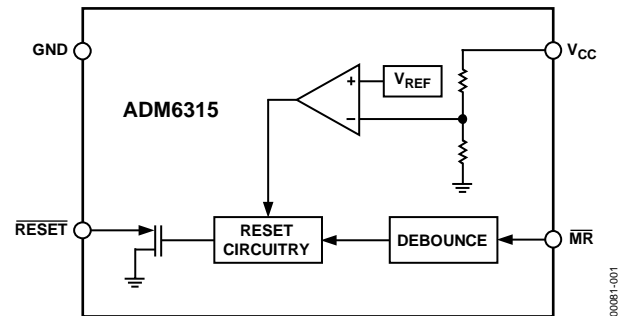

Figure 1.

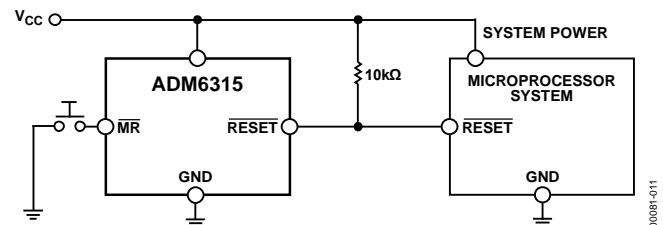

Figure 2. Typical Operating Circuit

The manual reset function is very useful, especially if the circuit in which the [ADM6315](#) is operating enters into a state that can be detected only by the user. Allowing the user to reset a system manually can reduce the damage or danger that could otherwise be caused by an out-of-control or locked-up system.

The [ADM6315](#) is available in a cost- and space-efficient SOT-143 package.

# ADM6315\* Product Page Quick Links

Last Content Update: 11/01/2016

---

## Comparable Parts

View a parametric search of comparable parts

## Evaluation Kits

- ADSP-SC584 Evaluation Hardware for the ADSP-SC58x/ADSP-2158x SHARC Family (349-ball CSPBGA)
- ADSP-SC589 Evaluation Hardware for the ADSP-SC58x/ADSP-2158x SHARC Family (529-ball CSPBGA)
- The ADZS-BF707 Blackfin Low-power Imaging Platform (BLIP) evaluation hardware provides a low-cost hardware solution for evaluating vision platform targeting a vast array of real-time sensing applications.

## Documentation

### Data Sheet

- ADM6315: Open-Drain Microprocessor Supervisory Circuit in 4-Lead SOT-143 Data Sheet

## Reference Materials

### Product Selection Guide

- ADI Complementary Parts Guide - Supervisory Devices and DSP Processors
- Supervisory Devices Complementary Parts Guide for Altera FPGAs
- Supervisory Devices Complementary Parts Guide for Xilinx FPGAs

### Solutions Bulletins & Brochures

- Voltage Monitoring Products Applications Guide

## Design Resources

- ADM6315 Material Declaration
- PCN-PDN Information
- Quality And Reliability
- Symbols and Footprints

## Discussions

View all ADM6315 EngineerZone Discussions

## Sample and Buy

Visit the product page to see pricing options

## Technical Support

Submit a technical question or find your regional support number

---

## TABLE OF CONTENTS

Features .....	1	Typical Performance Characteristics .....	6
Applications .....	1	Theory of Operation .....	7
Functional Block Diagram .....	1	Interfacing to Output of Other Devices .....	7
General Description .....	1	Benefits of a Very Accurate <u>RESET</u> Threshold .....	7
Revision History .....	2	Detailed Description .....	7
Specifications .....	3	Manual Reset Input .....	7
Absolute Maximum Ratings .....	4	Transient Immunity .....	7
Thermal Resistance .....	4	Outline Dimensions .....	8
ESD Caution .....	4	Ordering Guide .....	8
Pin Configuration and Function Descriptions .....	5	Automotive Products .....	9

## REVISION HISTORY

### 9/13—Rev. F to Rev. G

Changed Date in Revision F Revision History .....	2
Updated Outline Dimensions .....	8

### 12/11—Rev. E to Rev. F

Added Automotive Part .....	Universal
Changes to Ordering Guide .....	8

### 9/07—Rev. D to Rev. E

Changes to Absolute Maximum Ratings .....	4
Updated Outline Dimensions .....	8
Changes to Ordering Guide .....	8

### 4/06—Rev. C to Rev. D

Updated Format .....	Universal
Updated Outline Dimensions .....	8
Changes to Ordering Guide .....	8

### 12/03—Rev. B to Rev. C

Edit to Absolute Maximum Ratings .....	3
Edits to Ordering Guide .....	4
Deleted Table I and Table II .....	6
Deleted Table III and Table IV .....	7
Updated Outline Dimensions .....	8

### 2/03—Rev. A to Rev. B

Edits to Features .....	1
Edits to Specifications .....	2
Edits to Absolute Maximum Ratings .....	3
Edits to Ordering Guide .....	3
Edits to Table I and Table II .....	6
Edits to Table III and Table IV .....	7
Updated Outline Dimensions .....	8

### 10/01—Rev. 0 to Rev. A

Edits to Table III .....	7
Edits to Table IV .....	7

### 1999—Revision 0: Initial Version

## SPECIFICATIONS

$V_{CC}$  = full operating range,  $T_A = T_{MIN}$  to  $T_{MAX}$ ,  $V_{CC}$  typical = 5 V, unless otherwise noted.

Table 1.

Parameter	Min	Typ	Max	Unit	Test Conditions/Comments
SUPPLY					
Operating Voltage	1		5.5	V	$T_A = -40^{\circ}\text{C}$ to $+85^{\circ}\text{C}$
$V_{CC}$ Supply Current		5	12	$\mu\text{A}$	$V_{CC} = 5.5\text{ V}$ , no load, $T_A = -40^{\circ}\text{C}$ to $+85^{\circ}\text{C}$
			15	$\mu\text{A}$	$V_{CC} = 5.5\text{ V}$ , no load, $T_A = -40^{\circ}\text{C}$ to $+125^{\circ}\text{C}$
		4	10	$\mu\text{A}$	$V_{CC} = 3.6\text{ V}$ , no load, $T_A = -40^{\circ}\text{C}$ to $+85^{\circ}\text{C}$
			12	$\mu\text{A}$	$V_{CC} = 3.6\text{ V}$ , no load, $T_A = -40^{\circ}\text{C}$ to $+125^{\circ}\text{C}$
RESET VOLTAGE THRESHOLD ( $V_{TH}$ )					
	$V_{TH} - 1.8\%$	$V_{TH}$	$V_{TH} + 1.8\%$	V	$T_A = 25^{\circ}\text{C}$
	$V_{TH} - 2.5\%$		$V_{TH} + 2.5\%$	V	$T_A = -40^{\circ}\text{C}$ to $+85^{\circ}\text{C}$
	$V_{TH} - 3.5\%$		$V_{TH} + 3.5\%$	V	$T_A = -40^{\circ}\text{C}$ to $+125^{\circ}\text{C}$
RESET THRESHOLD TEMPERATURE COEFFICIENT					
		60		ppm/ $^{\circ}\text{C}$	
$V_{CC}$ TO RESET DELAY					
		35		$\mu\text{s}$	$V_{CC}$ = falling at 1 mV/ $\mu\text{s}$
RESET ACTIVE TIMEOUT PERIOD					
ADM6315xxD1	1	1.4	2	ms	$T_A = -40^{\circ}\text{C}$ to $+85^{\circ}\text{C}$
	0.8		2.4	ms	$T_A = -40^{\circ}\text{C}$ to $+125^{\circ}\text{C}$
ADM6315xxD2	20	28	40	ms	$T_A = -40^{\circ}\text{C}$ to $+85^{\circ}\text{C}$
	16		48	ms	$T_A = -40^{\circ}\text{C}$ to $+125^{\circ}\text{C}$
ADM6315xxD3	140	200	280	ms	$T_A = -40^{\circ}\text{C}$ to $+85^{\circ}\text{C}$
	112		336	ms	$T_A = -40^{\circ}\text{C}$ to $+125^{\circ}\text{C}$
ADM6315xxD4	1120	1570	2240	ms	$T_A = -40^{\circ}\text{C}$ to $+85^{\circ}\text{C}$
	896		2688	ms	$T_A = -40^{\circ}\text{C}$ to $+125^{\circ}\text{C}$
MANUAL RESET					
Input Threshold	0.8			V	$V_{TH} > 4\text{ V}$ ( $V_{IL}$ )
			2.4	V	$V_{TH} > 4\text{ V}$ ( $V_{IH}$ )
	$0.3 \times V_{CC}$			V	$V_{TH} < 4\text{ V}$ ( $V_{IL}$ )
			$0.7 \times V_{CC}$	V	$V_{TH} < 4\text{ V}$ ( $V_{IH}$ )
Minimum Input Pulse	1			$\mu\text{s}$	
Glitch Rejection		100		ns	
To Reset Delay		500		ns	
Pull-Up Resistance	32	63	100	k $\Omega$	
RESET OUTPUT					
Output Voltage			0.4	V	$V_{CC} > 4.25\text{ V}$ , $I_{SINK} = 3.2\text{ mA}$
			0.3	V	$V_{CC} > 2.5\text{ V}$ , $I_{SINK} = 1.2\text{ mA}$
			0.3	V	$V_{CC} > 1\text{ V}$ , $I_{SINK} = 80\text{ }\mu\text{A}$
Output Leakage Current			1	$\mu\text{A}$	$V_{CC} > V_{TH}$ , $\overline{\text{RESET}}$ deasserted

## ABSOLUTE MAXIMUM RATINGS

$T_A = 25^\circ\text{C}$ , unless otherwise noted.

Table 2.

Parameter	Rating
Terminal Voltage (with Respect to Ground)	
$V_{CC}$	–0.3 V to +6 V
All Other Inputs	–0.3 V to +6 V
Input Current	
$V_{CC}$	20 mA
Output Current	
$\overline{\text{RESET}}$	20 mA
Operating Temperature Range	–40°C to +125°C
Storage Temperature Range	–65°C to +160°C
Lead Temperature (Soldering, 10 sec)	300°C
Vapor Phase (60 sec)	215°C
Infrared (15 sec)	220°C
ESD Rating	2.5 kV

Stresses above those listed under Absolute Maximum Ratings may cause permanent damage to the device. This is a stress rating only; functional operation of the device at these or any other conditions above those indicated in the operational section of this specification is not implied. Exposure to absolute maximum rating conditions for extended periods may affect device reliability.

## THERMAL RESISTANCE

$\theta_{JA}$  is specified for the worst-case conditions, that is, a device soldered in a circuit board for surface-mount packages.

Table 3. Thermal Resistance

Package Type	$\theta_{JA}$	Unit
4-Lead SOT-143	330	°C/W

## ESD CAUTION



**ESD (electrostatic discharge) sensitive device.** Charged devices and circuit boards can discharge without detection. Although this product features patented or proprietary protection circuitry, damage may occur on devices subjected to high energy ESD. Therefore, proper ESD precautions should be taken to avoid performance degradation or loss of functionality.

## PIN CONFIGURATION AND FUNCTION DESCRIPTIONS

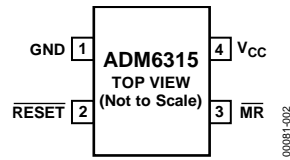

Figure 3. Pin Configuration

Table 4. Pin Function Descriptions

Pin No.	Mnemonic	Description
1	GND	Ground Reference for All Signals, 0 V.
2	$\overline{\text{RESET}}$	Active Low Logic Output. $\overline{\text{RESET}}$ remains low while $V_{CC}$ is below the reset threshold or when $\overline{\text{MR}}$ is low. $\overline{\text{RESET}}$ then remains low for a minimum of 1 ms, 20 ms, 140 ms, or 1120 ms after $V_{CC}$ rises above the reset threshold and MR is high.
3	$\overline{\text{MR}}$	Manual Reset. This active low debounced input ignores input pulses of 100 ns (typical) and is guaranteed to accept input pulses of greater than 1 $\mu\text{s}$ . Leave floating when not used.
4	$V_{CC}$	Monitored Supply Voltage.

TYPICAL PERFORMANCE CHARACTERISTICS

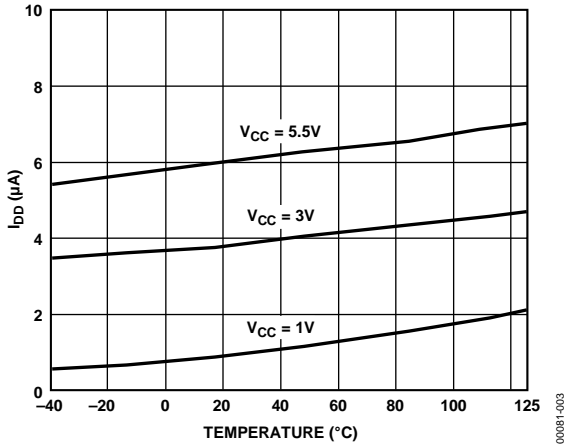

Figure 4. Supply Current vs. Temperature

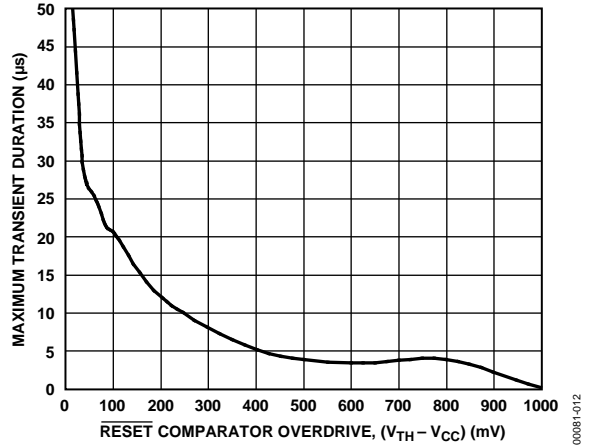

Figure 7. Maximum Transient Duration vs.  $\overline{RESET}$  Comparator Overdrive

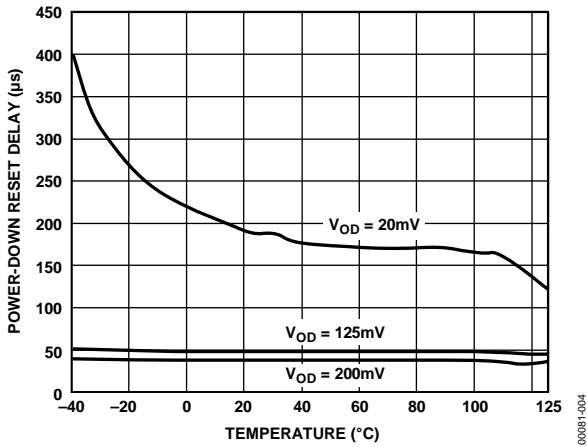

Figure 5. Power-Down Reset Delay vs. Temperature

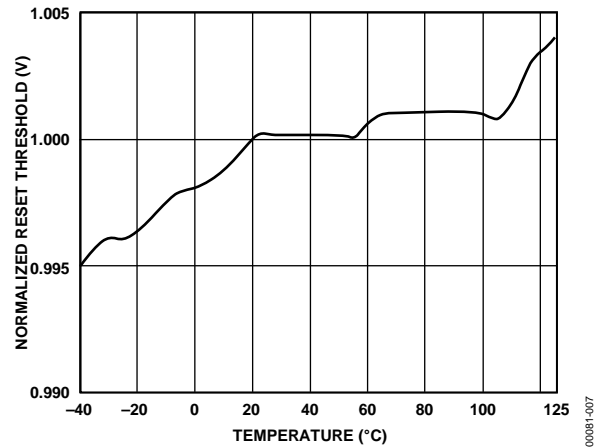

Figure 8. Normalized Reset Threshold vs. Temperature ( $V_{CC}$  Falling)

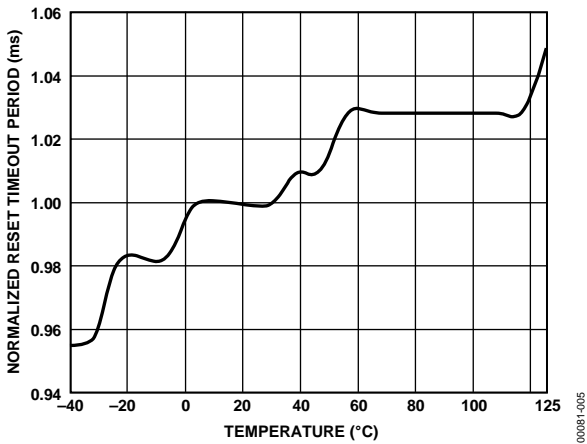

Figure 6. Normalized Reset Timeout Period vs. Temperature ( $V_{CC}$  Rising)

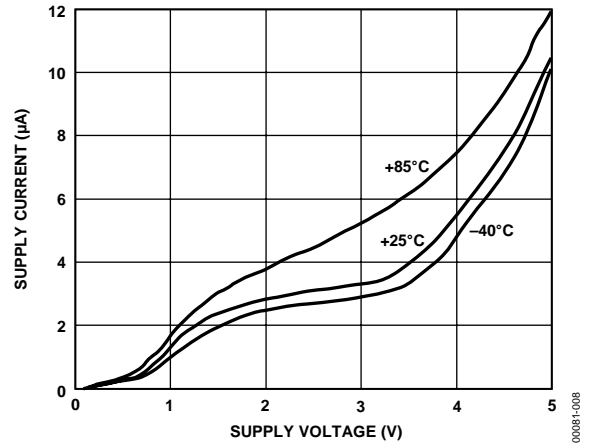

Figure 9. Supply Current vs. Supply Voltage

## THEORY OF OPERATION

### INTERFACING TO OUTPUT OF OTHER DEVICES

The ADM6315 series is designed to integrate with as many devices as possible. One feature of the ADM6315 is the RESET open-drain output, which can sink current from sources with a voltage greater than the  $V_{CC}$  of the ADM6315 input, making it suitable for use in more diverse applications.

### BENEFITS OF A VERY ACCURATE RESET THRESHOLD

Because the ADM6315 series can operate effectively even when there are large degradations of the supply voltages (due to an accurate internal voltage reference circuit), the possibility of a malfunction during a power failure is greatly reduced.

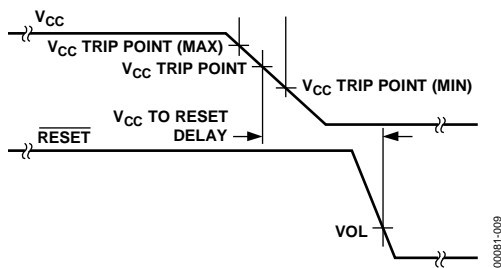

Figure 10.  $V_{CC}$  Power-Down/Brownout Timing Diagram

### DETAILED DESCRIPTION

The ADM6315 is designed to protect the integrity of a system's operation by ensuring the proper operation of the system during power-up, power-down, and brownout conditions.

When the ADM6315 is powered up, the RESET output of the ADM6315 remains low for a period typically equal to the RESET active timeout period. This feature allows adequate time for the system to power up correctly and for the power supply to stabilize before any devices are brought out of reset and allowed to begin executing instructions. Initializing a system in this way provides a more reliable startup for microprocessor systems.

When a brownout condition occurs (assuming  $V_{CC}$  is falling at  $1 \text{ mV}/\mu\text{s}$ ), the ADM6315 produces a reset in  $35 \mu\text{s}$  typical. Producing a reset this fast means that the entire system can be reset together before any part of the system's voltage falls below its recommended operating voltage. This system reset can avoid dangerous and/or erroneous operation of a microprocessor-based system.

### MANUAL RESET INPUT

The ADM6315 also provides an additional input, MR. This input can be used either as a means for the system operator to reset the system manually via a switch or for a digital circuit to reset the system.

The MR input (typically) ignores negative-going pulses that are faster than  $100 \text{ ns}$ , and it is guaranteed to accept any negative-going input pulse of a duration greater than or equal to  $1 \mu\text{s}$ . If MR is connected to long cables or is used in a noisy environment, placing a  $1 \mu\text{F}$  decoupling capacitor between the MR input and ground further improves the glitch immunity of the ADM6315.

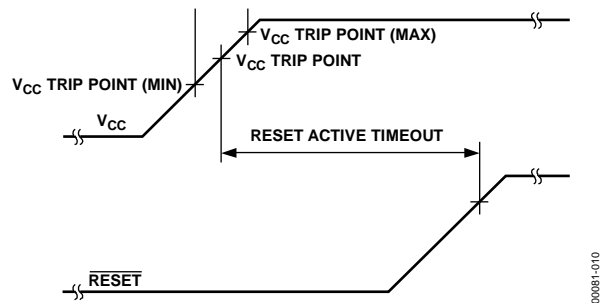

Figure 11.  $V_{CC}$  Power-Up Timing Diagram

### TRANSIENT IMMUNITY

As well as being an accurate reset circuit, the ADM6315 has good immunity from negative-going transients (see Figure 7). Because of this characteristic, the ADM6315 is suitable for use in noisy environments.

Figure 7 shows the RESET comparator overdrive (the maximum magnitude of negative-going pulses with respect to the typical reset threshold) vs. the pulse duration without a reset.



OUTLINE DIMENSIONS

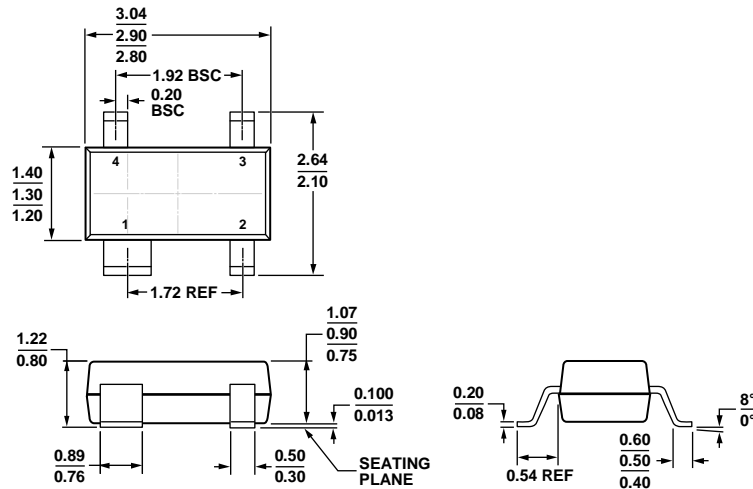

COMPLIANT TO JEDEC STANDARDS TO-253-AA

Figure 12. 4-Lead Small Outline Transistor Package [SOT-143] (RA-4)

Dimensions shown in millimeters

03-13-2012-B

ORDERING GUIDE

Model <sup>1, 2</sup>	Temperature Range	Package Description	Package Option	Trip Point	Minimum Timeout (ms)	Branding
ADM6315-46D1ARTL7	-40°C to +125°C	4-Lead Small Outline Transistor [SOT-143]	RA-4	4.63	1	MDV
ADM6315-46D1ART-RL	-40°C to +125°C	4-Lead Small Outline Transistor [SOT-143]	RA-4	4.63	1	MDV
ADM6315-46D1ARTZR7	-40°C to +125°C	4-Lead Small Outline Transistor [SOT-143]	RA-4	4.63	1	M9Q
ADM6315-45D1ARTL7	-40°C to +125°C	4-Lead Small Outline Transistor [SOT-143]	RA-4	4.50	1	MDU
ADM6315-45D1ART-RL	-40°C to +125°C	4-Lead Small Outline Transistor [SOT-143]	RA-4	4.50	1	MDU
ADM6315-45D1ARTZR7	-40°C to +125°C	4-Lead Small Outline Transistor [SOT-143]	RA-4	4.50	1	M81
ADM6315-44D1ARTL7	-40°C to +125°C	4-Lead Small Outline Transistor [SOT-143]	RA-4	4.39	1	MDT
ADM6315-44D1ART-RL	-40°C to +125°C	4-Lead Small Outline Transistor [SOT-143]	RA-4	4.39	1	MDT
ADM6315-31D1ARTL7	-40°C to +125°C	4-Lead Small Outline Transistor [SOT-143]	RA-4	3.08	1	MDG
ADM6315-31D1ARTZR7	-40°C to +125°C	4-Lead Small Outline Transistor [SOT-143]	RA-4	3.08	1	M7X
ADM6315-31D1ARTZRL	-40°C to +125°C	4-Lead Small Outline Transistor [SOT-143]	RA-4	3.08	1	M7X
ADM6315-29D1ARTL7	-40°C to +125°C	4-Lead Small Outline Transistor [SOT-143]	RA-4	2.93	1	MDC
ADM6315-29D1ART-RL	-40°C to +125°C	4-Lead Small Outline Transistor [SOT-143]	RA-4	2.93	1	MDC
ADM6315-29D1ARTZR7	-40°C to +125°C	4-Lead Small Outline Transistor [SOT-143]	RA-4	2.93	1	M7T
ADM6315-26D1ARTL7	-40°C to +125°C	4-Lead Small Outline Transistor [SOT-143]	RA-4	2.63	1	MDB
ADM6315-26D1ART-RL	-40°C to +125°C	4-Lead Small Outline Transistor [SOT-143]	RA-4	2.63	1	MDB
ADM6315-26D1ARTZR7	-40°C to +125°C	4-Lead Small Outline Transistor [SOT-143]	RA-4	2.63	1	MDB#
ADM6315-26D1ARTZRL	-40°C to +125°C	4-Lead Small Outline Transistor [SOT-143]	RA-4	2.63	1	MDB#
ADM6315-46D2ARTL7	-40°C to +125°C	4-Lead Small Outline Transistor [SOT-143]	RA-4	4.63	20	MEV
ADM6315-46D2ART-RL	-40°C to +125°C	4-Lead Small Outline Transistor [SOT-143]	RA-4	4.63	20	MEV
ADM6315-45D2ARTL7	-40°C to +125°C	4-Lead Small Outline Transistor [SOT-143]	RA-4	4.50	20	MEU
ADM6315-45D2ART-RL	-40°C to +125°C	4-Lead Small Outline Transistor [SOT-143]	RA-4	4.50	20	MEU
ADM6315-45D2ARTZR7	-40°C to +125°C	4-Lead Small Outline Transistor [SOT-143]	RA-4	4.50	20	MA8
ADM6315-44D2ARTL7	-40°C to +125°C	4-Lead Small Outline Transistor [SOT-143]	RA-4	4.39	20	MET
ADM6315-44D2ART-RL	-40°C to +125°C	4-Lead Small Outline Transistor [SOT-143]	RA-4	4.39	20	MET
ADM6315-44D2ARTZR7	-40°C to +125°C	4-Lead Small Outline Transistor [SOT-143]	RA-4	4.39	20	M80
ADM6315-31D2ARTL7	-40°C to +125°C	4-Lead Small Outline Transistor [SOT-143]	RA-4	3.08	20	MEG
ADM6315-31D2ARTZR7	-40°C to +125°C	4-Lead Small Outline Transistor [SOT-143]	RA-4	3.08	20	M7Y
ADM6315-31D2ARTZRL	-40°C to +125°C	4-Lead Small Outline Transistor [SOT-143]	RA-4	3.08	20	M7Y
ADM6315W31D2ARTZR7	-40°C to +125°C	4-Lead Small Outline Transistor [SOT-143]	RA-4	3.08	20	LLV

Model <sup>1, 2</sup>	Temperature Range	Package Description	Package Option	Trip Point	Minimum Timeout (ms)	Branding
ADM6315-29D2ARTL7	-40°C to +125°C	4-Lead Small Outline Transistor [SOT-143]	RA-4	2.93	20	MEC
ADM6315-29D2ART-RL	-40°C to +125°C	4-Lead Small Outline Transistor [SOT-143]	RA-4	2.93	20	MEC
ADM6315-29D2ARTZR7	-40°C to +125°C	4-Lead Small Outline Transistor [SOT-143]	RA-4	2.93	20	M7U
ADM6315-26D2ARTL7	-40°C to +125°C	4-Lead Small Outline Transistor [SOT-143]	RA-4	2.63	20	MEB
ADM6315-26D2ARTZR7	-40°C to +125°C	4-Lead Small Outline Transistor [SOT-143]	RA-4	2.63	20	MEB#
ADM6315-26D2ARTZRL	-40°C to +125°C	4-Lead Small Outline Transistor [SOT-143]	RA-4	2.63	20	MEB#
ADM6315-46D3ARTL7	-40°C to +125°C	4-Lead Small Outline Transistor [SOT-143]	RA-4	4.63	140	MFV
ADM6315-46D3ART-RL	-40°C to +125°C	4-Lead Small Outline Transistor [SOT-143]	RA-4	4.63	140	MFV
ADM6315-46D3ARTZR7	-40°C to +125°C	4-Lead Small Outline Transistor [SOT-143]	RA-4	4.63	140	M84
ADM6315-45D3ARTL7	-40°C to +125°C	4-Lead Small Outline Transistor [SOT-143]	RA-4	4.50	140	MFU
ADM6315-45D3ART-RL	-40°C to +125°C	4-Lead Small Outline Transistor [SOT-143]	RA-4	4.50	140	MFU
ADM6315-45D3ARTZR7	-40°C to +125°C	4-Lead Small Outline Transistor [SOT-143]	RA-4	4.50	140	M82
ADM6315-44D3ARTL7	-40°C to +125°C	4-Lead Small Outline Transistor [SOT-143]	RA-4	4.39	140	MFT
ADM6315-44D3ARTZR7	-40°C to +125°C	4-Lead Small Outline Transistor [SOT-143]	RA-4	4.39	140	MFT#
ADM6315-44D3ARTZRL	-40°C to +125°C	4-Lead Small Outline Transistor [SOT-143]	RA-4	4.39	140	MFT#
ADM6315-31D3ARTL7	-40°C to +125°C	4-Lead Small Outline Transistor [SOT-143]	RA-4	3.08	140	MFG
ADM6315-31D3ART-RL	-40°C to +125°C	4-Lead Small Outline Transistor [SOT-143]	RA-4	3.08	140	MFG
ADM6315-31D3ARTZR7	-40°C to +125°C	4-Lead Small Outline Transistor [SOT-143]	RA-4	3.08	140	M4G
ADM6315-31D3ARTZRL	-40°C to +125°C	4-Lead Small Outline Transistor [SOT-143]	RA-4	3.08	140	M4G
ADM6315-29D3ARTL7	-40°C to +125°C	4-Lead Small Outline Transistor [SOT-143]	RA-4	2.93	140	MFC
ADM6315-29D3ART-RL	-40°C to +125°C	4-Lead Small Outline Transistor [SOT-143]	RA-4	2.93	140	MFC
ADM6315-29D3ARTZR7	-40°C to +125°C	4-Lead Small Outline Transistor [SOT-143]	RA-4	2.93	140	M7V
ADM6315-26D3ARTZR7	-40°C to +125°C	4-Lead Small Outline Transistor [SOT-143]	RA-4	2.63	140	MFB#
ADM6315-26D3ARTZRL	-40°C to +125°C	4-Lead Small Outline Transistor [SOT-143]	RA-4	2.63	140	MFB#
ADM6315-46D4ARTL7	-40°C to +125°C	4-Lead Small Outline Transistor [SOT-143]	RA-4	4.63	1120	MGV
ADM6315-46D4ART-RL	-40°C to +125°C	4-Lead Small Outline Transistor [SOT-143]	RA-4	4.63	1120	MGV
ADM6315-46D4ARTZR7	-40°C to +125°C	4-Lead Small Outline Transistor [SOT-143]	RA-4	4.63	1120	M85
ADM6315-45D4ARTL7	-40°C to +125°C	4-Lead Small Outline Transistor [SOT-143]	RA-4	4.50	1120	MGU
ADM6315-45D4ART-RL	-40°C to +125°C	4-Lead Small Outline Transistor [SOT-143]	RA-4	4.50	1120	MGU
ADM6315-44D4ARTL7	-40°C to +125°C	4-Lead Small Outline Transistor [SOT-143]	RA-4	4.39	1120	MGT
ADM6315-44D4ARTZR7	-40°C to +125°C	4-Lead Small Outline Transistor [SOT-143]	RA-4	4.39	1120	M9H
ADM6315-44D4ARTZRL	-40°C to +125°C	4-Lead Small Outline Transistor [SOT-143]	RA-4	4.39	1120	M9H
ADM6315-31D4ARTL7	-40°C to +125°C	4-Lead Small Outline Transistor [SOT-143]	RA-4	3.08	1120	MGG
ADM6315-31D4ART-RL	-40°C to +125°C	4-Lead Small Outline Transistor [SOT-143]	RA-4	3.08	1120	MGG
ADM6315-31D4ARTZR7	-40°C to +125°C	4-Lead Small Outline Transistor [SOT-143]	RA-4	3.08	1120	M7Z
ADM6315-29D4ARTL7	-40°C to +125°C	4-Lead Small Outline Transistor [SOT-143]	RA-4	2.93	1120	MGC
ADM6315-29D4ART-RL	-40°C to +125°C	4-Lead Small Outline Transistor [SOT-143]	RA-4	2.93	1120	MGC
ADM6315-29D4ARTZR7	-40°C to +125°C	4-Lead Small Outline Transistor [SOT-143]	RA-4	2.93	1120	M7W
ADM6315-26D4ARTL7	-40°C to +125°C	4-Lead Small Outline Transistor [SOT-143]	RA-4	2.63	1120	MGB
ADM6315-26D4ART-RL	-40°C to +125°C	4-Lead Small Outline Transistor [SOT-143]	RA-4	2.63	1120	MGB
ADM6315-26D4ARTZR7	-40°C to +125°C	4-Lead Small Outline Transistor [SOT-143]	RA-4	2.63	1120	MGB#
ADM6315-26D4ARTZRL	-40°C to +125°C	4-Lead Small Outline Transistor [SOT-143]	RA-4	2.63	1120	MGB#

<sup>1</sup> Z = RoHS-Compliant Part, # denotes lead-free product may be top or bottom marked.

<sup>2</sup> W = Qualified for Automotive Applications.

## AUTOMOTIVE PRODUCTS

The [ADM6315W](#) model is available with controlled manufacturing to support the quality and reliability requirements of automotive applications. Note that these automotive models may have specifications that differ from the commercial models; therefore, designers should review the Specifications section of this data sheet carefully. Only the automotive grade products shown are available for use in automotive applications. Contact your local Analog Devices account representative for specific product ordering information and to obtain the specific Automotive Reliability reports for these models.

**NOTES**

**NOTES**

**NOTES**