

Compact EMC/RFI Filter for Motor Drives



- Compact filter solution for single-phase motor drive applications
- Industrial grade safety terminal blocks
- Designed to meet EN 55011/14/22
- Compliant with IEC 60950



Performance indicators

Attenuation performance



Rated current [A]



Technical specifications

Maximum continuous operating voltage	1x 250 VAC
Operating frequency	dc to 400 Hz
Rated currents	8 to 55 A @ 40°C max.
High potential test voltage	P → E 2000 VAC for 2 sec P → N 1100 VDC for 2 sec
Protection category	IP 20
Overload capability	4x rated current at switch on, 1.5x rated current for 1 minute, once per hour
Temperature range (operation and storage)	-25°C to +100°C (25/100/21)
Flammability corresponding to	UL 94 V-2 or better
Design corresponding to	UL 1283, CSA 22.2 No. 8 1986, IEC/EN 60939
MTBF @ 40°C/230 V (Mil-HB-217F)	420,000 hours

Approvals



Features and benefits

- High component values optimized for common and differential-mode attenuation in the lower frequency range makes this filter ideal for a large variety of single-phase motor drive applications
- Supplied in a relatively small housing design with safety terminal blocks for fast and easy installation in primarily industrial environments
- FN 350 also meets IEC 60950 requirements, thus providing additional application flexibility

Typical applications

- Single-phase motor drives
- Automation equipment
- Power supplies, SMPS
- Office equipment
- Testing and measurements equipment

Typical electrical schematic

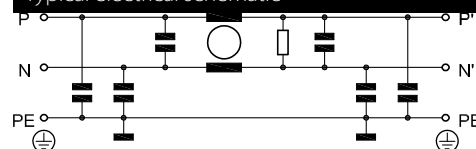

Filter selection table

Filter	Rated current	Leakage current*	Power loss	Input/Output connections	Weight
	@ 40°C (25°C)	@ 230 VAC/50 Hz	@ 25°C/50 Hz		
	[A]	[mA]	[W]		[kg]
FN 350-8-29	8 (9.0)	4.9	5.2	-29	0.7
FN 350-12-29	12 (13.5)	4.9	5.7	-29	0.7
FN 350-20-29	20 (22.4)	4.9	6.1	-29	0.7
FN 350-30-33	30 (33.6)	5.4	6.1	-33	0.7
FN 350-55-33	55 (61.5)	11.0	9.9	-33	1.2

* Maximum leakage under normal operating conditions. Note: if the neutral line is interrupted, worst case leakage could reach twice this level.

Typical filter attenuation

Per CISPR 17; A = 50 Ω/50 Ω sym; B = 50 Ω/50 Ω asym; C = 0.1 Ω/100 Ω sym; D = 100 Ω/0.1 Ω sym

8 A types

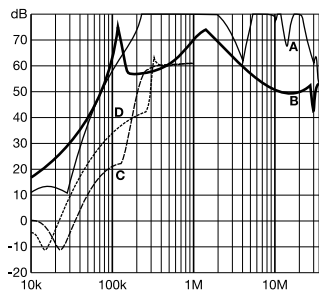

12 A types

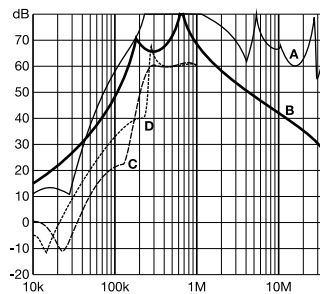

20 and 30 A types

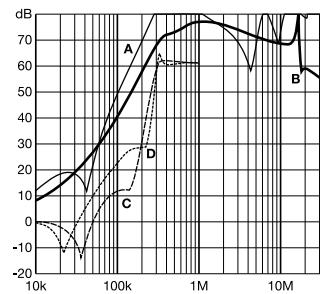

55 A types

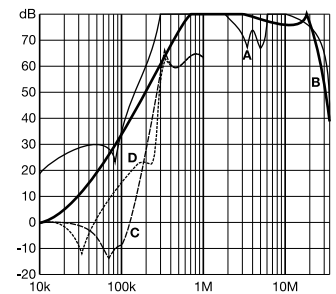

Mechanical data

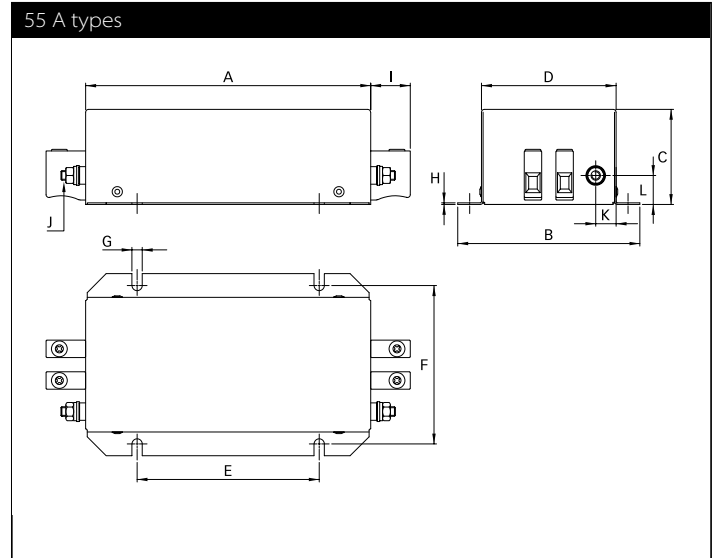
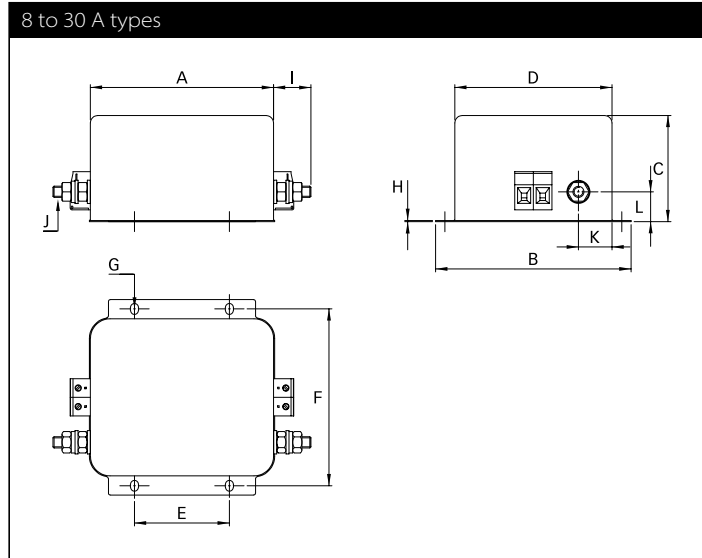

Dimensions

	8 A	12 A	20 A	30 A	55 A
A	99.5	99.5	99.5	99.5	180
B	105	105	105	105	115
C	57	57	57	57.6	60
D	84.4	84.4	84.4	84.4	85
E	51	51	51	51	115
F	95	95	95	95	100
G	6 x 4.4	6 x 4.4	6 x 4.4	6 x 4.4	6.5
H	0.6	0.6	0.6	1.2	1
I	19.5	19.5	19.5	25	25
J	M6	M6	M6	M6	M6
K	18	18	18	16	12.9
L	16	16	16	19	18.3

All dimensions in mm; 1 inch = 25.4 mm
Tolerances according: ISO 2768-m/EN 22768-m

Filter input/output connector cross sections

	-29	-33
Solid wire	6 mm ²	16 mm ²
Flex wire	4 mm ²	10 mm ²
AWG type wire	AWG 10	AWG 6
Recommended torque	0.6-0.8 Nm	1.5-1.8 Nm

Please visit www.schaffner.com to find more details on filter connectors.



Headquarters, global innovation and development

Switzerland

Schaffner Group

Nordstrasse 11
4542 Luterbach
T +41 32 681 66 26
F +41 32 681 66 30
info@schaffner.com
<http://www.schaffner.com>



Sales and application centers

China

Schaffner EMC Ltd. Shanghai

T20-3 C, No 565 Chuangye Road,
Pudong district
201201 Shanghai
T +86 21 3813 9500
cschina@schaffner.com
<http://www.schaffner.com.cn>

Finland

Schaffner Oy

Sauvonrinne 19 H
08500 Lohja
T +358 10 567 2855
finlandsales@schaffner.com

France

Schaffner EMC S.A.S.

112 Quai de Bezons
95100 Argenteuil
T +33 1 34 34 30 60
F +33 1 39 47 02 28
francesales@schaffner.com

Germany

Schaffner Deutschland GmbH

Schoemperlenstrasse 12B
76185 Karlsruhe
T +49 721 56910
F +49 721 569110
germanysales@schaffner.com

India

Schaffner India Pvt. Ltd

Unit 59, Level, Mfar Greenheart 7
Manyata Tech Park, Hebbal Outer Ring Road
560045 Bangalore
T +91 80 6781 9805
F +91 80 6781 9998
indiasales@schaffner.com

Italy

Schaffner EMC S.r.l.

Via Galileo Galilei 47
20092 Cinisello Balsamo (MI)
T +39 02 66 04 30 45 /47
F +39 02 61 23 943
italysales@schaffner.com

Japan

Schaffner EMC K.K.

1-32-12, Kamiyama, Setagaya-ku
7F Mitsui-seimei Sangenjaya Bldg.
154-0011 Tokyo
T +81 3 5712 3650
F +81 3 5712 3651
japansales@schaffner.com
<http://www.schaffner.jp>

Singapore

Schaffner EMC Pte Ltd.

#05-09, Kg Ubi Ind. Estate
408705 Singapore
T +65 6377 3283
F +65 6377 3281
singaporesales@schaffner.com

Spain

Schaffner EMC España

Calle Caléndula 93, Miniparc III, Edificio E
El Soto de Moraleja, Alcobendas
28109 Madrid
T +34 917 912 900
F +34 917 912 901
spainsales@schaffner.com

Sweden

Schaffner EMC AB

Tegeluddsvägen 76, 2tr
115 28 Stockholm
T +46 8 5050 2425
swedensales@schaffner.com
<http://www.schaffner.com>

Switzerland

Schaffner EMV AG

Nordstrasse 11
4542 Luterbach
T +41 32 681 66 26
switzerlandsales@schaffner.com

Taiwan R.O.C.

Schaffner EMV Ltd.

20 Floor-2, No 97, Section 1, XinTai 5th Road
22175 XiZhi District New Taipei City 22175
T +886 2 2697 5500
F +886 2 2697 5533
taiwansales@schaffner.com
<http://www.schaffner.tw>

Thailand

Schaffner EMC Co. Ltd.

Northern Region Industrial Estate
67 Moo 4 Tambon Ban Klang
Amphur Muangng P.O. Box 14
51000 Lamphun
T +66 53 58 11 04
F +66 53 58 10 19
thailandsales@schaffner.com

United Kingdom

Schaffner Ltd.

5 Ashville Way, Molly Millars Lane
Wokingham
RG41 2PL Berkshire
T +44 118 9770070
F +44 118 9792969
uksales@schaffner.com

USA

Schaffner EMC Inc.

52 Mayfield Avenue
08837 Edison, New Jersey
T +1 800 367 5566
T +1 732 225 9533
F +1 732 225 4789
usasales@schaffner.com
<http://www.schaffnerusa.com>

Schaffner North America

6722 Thirlane Road
24019 Roanoke, Virginia
T +1 276 228 7943
F +1 276 228 7953

Schaffner North America

823 Fairview Road
24382 Wytheville, Virginia
T +1 276 228 7943
F +1 276 228 7258

To find your local partner within Schaffner's global network: www.schaffner.com

© 2016 Schaffner Group

The content of this document has been carefully checked and understood. However, neither Schaffner nor its subsidiaries assume any liability whatsoever for any errors or inaccuracies of this document and the consequences thereof. Published specifications are subject to change without notice. Product suitability for any area of application must ultimately be determined by the customer. In all cases, products must never be operated outside their published specifications. Schaffner does not guarantee the availability of all published products. This disclaimer shall be governed by substantive Swiss law and resulting disputes shall be settled by the courts at the place of business of Schaffner Holding AG. Latest publications and a complete disclaimer can be downloaded from the Schaffner website. All trademarks recognized.