

# 14.2mm (0.56") Single Digit Common Cathode LED Display

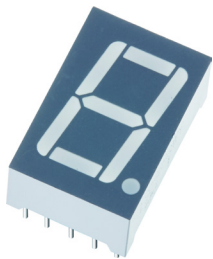

## Specifications

Dice Material	: GaP
Peak Wave Length	: 568 nm
Emitted Colour	: Green
Lens Colour	: White Diffused
IV(mcd)	: 2.4
Surface Ink Colour	: Black

## Electrical / Optical Characteristics at TA = 25°C

Parameter	Symbol	Min	Typ	Max	Unit	Test
Luminous Intensity	IV	1.2	2.4	3.8	mcd	IF = 20mA
Viewing Angle	2Θ1/2	-	-	-	deg	
Peak Emission Wavelength	λp	-	568	-	nm	
Dominant Wavelength	λD	-	570	-	nm	
Spectral Line Half-Width	Δλ	-	30	-	nm	
Forward Voltage	VF	1.8	2.2	2.6	V	
Power Dissipation	Pd	-	-	85	mW	
Peak Forward Current (Duty 1/10 @ 1kHz)	IF (Peak)	-	-	100	mA	
Recommended Operating Current	TF (Rec)	-	20	-	mA	

## Absolute Maximum Rating TA = 25°C

Reverse Voltage	5 Volt
Reverse Current	10μA (VR=5V)
Operating Temperature Range	-40°C to +85°C
Storage Temperature Range	-40°C to +100°C
Lead Soldering Temperature Range (1.6mm (1/16 inch) from body)	260°C For 5 Seconds

## Typical Electro-Optical Characteristics Curves

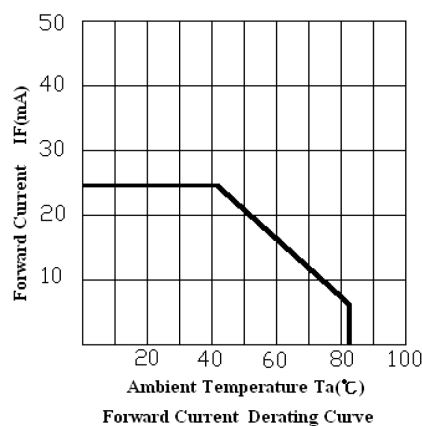
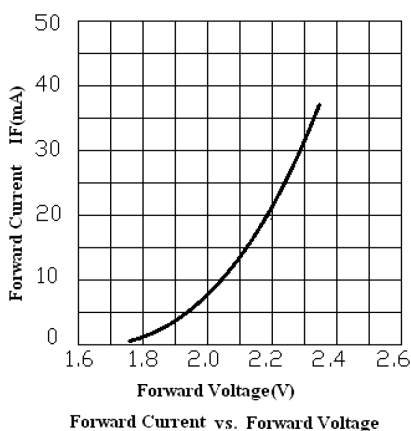

# 14.2mm (0.56") Single Digit Common Cathode LED Display

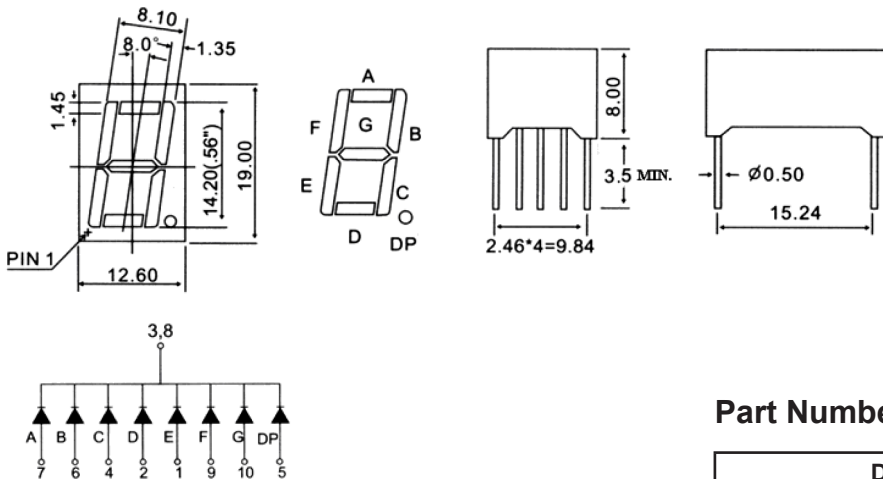
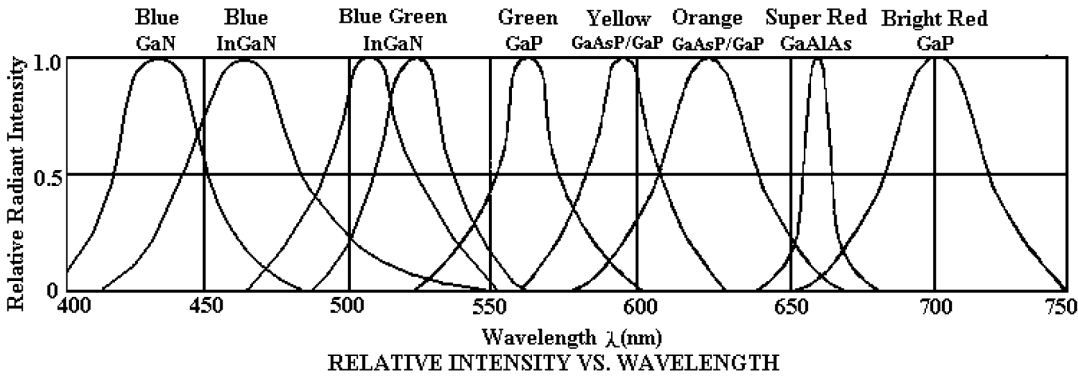
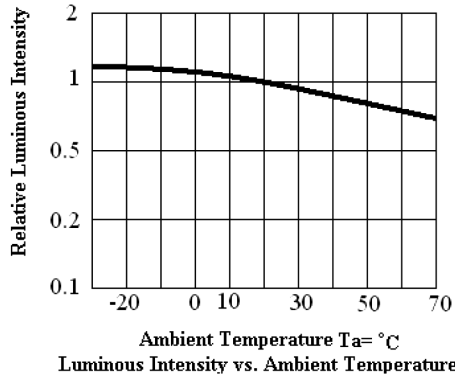
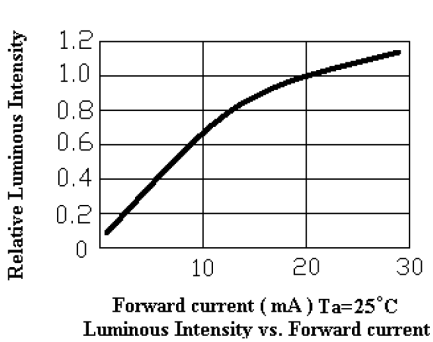

Dimensions : Millimetres  
Tolerance :  $\pm 0.25\text{mm}$

## Part Number Table

Description	Part Number
14.2mm (0.56") Single Digit Common Cathode LED Display, Green	LS0565GWK

**Important Notice :** This data sheet and its contents (the "Information") belong to the members of the Premier Farnell group of companies (the "Group") or are licensed to it. No licence is granted for the use of it other than for information purposes in connection with the products to which it relates. No licence of any intellectual property rights is granted. The Information is subject to change without notice and replaces all data sheets previously supplied. The Information supplied is believed to be accurate but the Group assumes no responsibility for its accuracy or completeness, any error in or omission from it or for any use made of it. Users of this data sheet should check for themselves the Information and the suitability of the products for their purpose and not make any assumptions based on information included or omitted. Liability for loss or damage resulting from any reliance on the Information or use of it (including liability resulting from negligence or where the Group was aware of the possibility of such loss or damage arising) is excluded. This will not operate to limit or restrict the Group's liability for death or personal injury resulting from its negligence. Multicomp is the registered trademark of the Group. © Premier Farnell Limited 2016.