



Is Now Part of



ON Semiconductor®

To learn more about ON Semiconductor, please visit our website at

www.onsemi.com

ON Semiconductor and the ON Semiconductor logo are trademarks of Semiconductor Components Industries, LLC dba ON Semiconductor or its subsidiaries in the United States and/or other countries. ON Semiconductor owns the rights to a number of patents, trademarks, copyrights, trade secrets, and other intellectual property. A listing of ON Semiconductor's product/patent coverage may be accessed at www.onsemi.com/site/pdf/Patent-Marking.pdf. ON Semiconductor reserves the right to make changes without further notice to any products herein. ON Semiconductor makes no warranty, representation or guarantee regarding the suitability of its products for any particular purpose, nor does ON Semiconductor assume any liability arising out of the application or use of any product or circuit, and specifically disclaims any and all liability, including without limitation special, consequential or incidental damages. Buyer is responsible for its products and applications using ON Semiconductor products, including compliance with all laws, regulations and safety requirements or standards, regardless of any support or applications information provided by ON Semiconductor. "Typical" parameters which may be provided in ON Semiconductor data sheets and/or specifications can and do vary in different applications and actual performance may vary over time. All operating parameters, including "Typicals" must be validated for each customer application by customer's technical experts. ON Semiconductor does not convey any license under its patent rights nor the rights of others. ON Semiconductor products are not designed, intended, or authorized for use as a critical component in life support systems or any FDA Class 3 medical devices or medical devices with a same or similar classification in a foreign jurisdiction or any devices intended for implantation in the human body. Should Buyer purchase or use ON Semiconductor products for any such unintended or unauthorized application, Buyer shall indemnify and hold ON Semiconductor and its officers, employees, subsidiaries, affiliates, and distributors harmless against all claims, costs, damages, and expenses, and reasonable attorney fees arising out of, directly or indirectly, any claim of personal injury or death associated with such unintended or unauthorized use, even if such claim alleges that ON Semiconductor was negligent regarding the design or manufacture of the part. ON Semiconductor is an Equal Opportunity/Affirmative Action Employer. This literature is subject to all applicable copyright laws and is not for resale in any manner.

HCPL0600, HCPL0601, HCPL0611, HCPL0637, HCPL0638, HCPL0639 High Speed-10 MBit/s Logic Gate Optocouplers

Single Channel: HCPL0600, HCPL0601, HCPL0611
Dual Channel: HCPL0637, HCPL0638, HCPL0639

Features

- Compact SO8 package
- Very high speed-10 MBit/s
- Superior CMR
- Logic gate output
- Storable output (single channel devices)
- Wired OR-open collector
- U.L. recognized (File # E90700)
- IEC60747-5-2 approved (VDE option)
 - HCPL0600, HCPL0601, HCPL0611 only

Applications

- Ground loop elimination
- LSTTL to TTL, LSTTL or 5-volt CMOS
- Line receiver, data transmission
- Data multiplexing
- Switching power supplies
- Pulse transformer replacement
- Computer-peripheral interface

Description

The HCPL06XX optocouplers consist of an AlGaAs LED, optically coupled to a very high speed integrated photo-detector logic gate with a storable output (single channel devices). The devices are housed in a compact small-outline package. This output features an open collector, thereby permitting wired OR outputs. The HCPL0600, HCPL0601 and HCPL0611 output consists of bipolar transistors on a bipolar process while the HCPL0637, HCPL0638, and HCPL0639 output consists of bipolar transistors on a CMOS process for reduced power consumption. The coupled parameters are guaranteed over the temperature range of -40°C to +85°C. An internal noise shield provides superior common mode rejection.

Package Dimensions

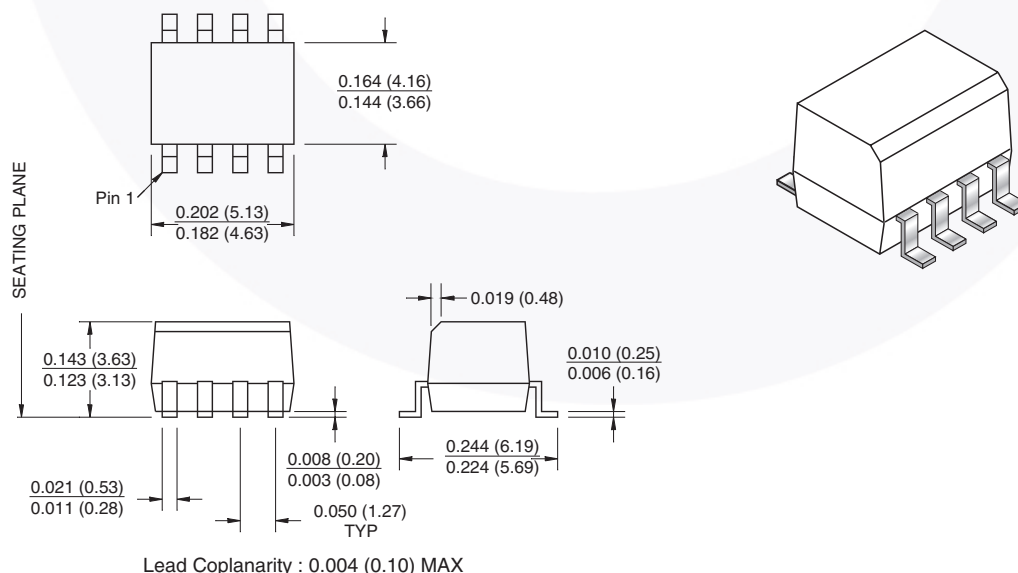

Note:

All dimensions are in inches (millimeters)



Single-channel circuit drawing
(HCPL0600, HCPL0601 and HCPL0611)



Dual-channel circuit drawing
(HCPL0637, HCPL0638 and HCPL0639)

Truth Table (Positive Logic)

Input	Enable	Output
H	H	L
L	H	H
H	L	H
L	L	H
H*	NC*	L*
L*	NC*	H*

*Dual channel devices or single channel devices with pin 7 not connected.
A 0.1 μ F bypass capacitor must be connected between pins 8 and 5. (See note 1)



Absolute Maximum Ratings (No derating required up to 85°C)

Stresses exceeding the absolute maximum ratings may damage the device. The device may not function or be operable above the recommended operating conditions and stressing the parts to these levels is not recommended. In addition, extended exposure to stresses above the recommended operating conditions may affect device reliability. The absolute maximum ratings are stress ratings only.

Symbol	Parameter	Value	Units	
T _{STG}	Storage Temperature	-40 to +125	°C	
T _{OPR}	Operating Temperature	-40 to +85	°C	
EMITTER				
I _F	DC/Average Forward Input Current (each channel)	Single Channel	50	mA
		Dual Channel		
V _E	Enable Input Voltage Not to exceed V _{CC} by more than 500mV	Single Channel	5.5	V
V _R	Reverse Input Voltage (each channel)		5.0	V
P _I	Power Dissipation	Single Channel	45	mW
		Dual Channel		
DETECTOR				
V _{CC} (1 minute max)	Supply Voltage		7.0	V
I _O	Output Current (each channel)	Single Channel	50	mA
		Dual Channel	15	
V _O	Output Voltage (each channel)		7.0	V
P _O	Collector Output Power Dissipation	Single Channel	85	mW
		Dual Channel	85	

Recommended Operating Conditions

The Recommended Operating Conditions table defines the conditions for actual device operation. Recommended operating conditions are specified to ensure optimal performance to the datasheet specifications. Fairchild does not recommend exceeding them or designing to absolute maximum ratings.

Symbol	Parameter	Min.	Max.	Units	
I _{FL}	Input Current, Low Level	0	250	μA	
I _{FH}	Input Current, High Level	*6.3	15	mA	
V _{CC}	Supply Voltage, Output	4.5	5.5	V	
V _{EL}	Enable Voltage, Low Level	Single Channel only	0	0.8	V
V _{EH}	Enable Voltage, High Level	Single Channel only	2.0	V _{CC}	V
T _A	Operating Temperature	-40	+85	°C	
N	Fan Out (TTL load)	Single Channel		8	TTL Loads
		Dual Channel		5	
R _L	Output Pull-up	330	4K	Ω	

*6.3mA is a guard banded value which allows for at least 20% CTR degradation. Initial input current threshold value is 5.0mA or less

Electrical Characteristics ($T_A = -40^\circ\text{C}$ to $+85^\circ\text{C}$ unless otherwise specified.)

Individual Component Characteristics

Symbol	Parameter	Test Conditions	Min.	Typ.*	Max.	Unit
EMITTER						
V_F	Input Forward Voltage	$I_F = 10\text{mA}$ $T_A = 25^\circ\text{C}$			1.8	V
					1.75	
B_{VR}	Input Reverse Breakdown Voltage	$I_R = 10\mu\text{A}$	5.0			V
$\Delta V_F/\Delta T_A$	Input Diode Temperature Coefficient	$I_F = 10\text{mA}$		-1.5		mV/ $^\circ\text{C}$
DETECTOR						
I_{CCH}	High Level Supply Current	$I_F = 0\text{mA}$, $V_{CC} = 5.5\text{V}$	$V_E = 0.5\text{V}$ Single Channel		10	mA
			Dual Channel		15	
I_{CCL}	Low Level Supply Current	$I_F = 10\text{mA}$, $V_{CC} = 5.5\text{V}$	$V_E = 0.5\text{V}$ Single Channel		13	mA
			Dual Channel		21	
I_{EL}	Low Level Enable Current	$V_{CC} = 5.5\text{V}$, $V_E = 0.5\text{V}$			-1.6	mA
I_{EH}	High Level Enable Current	$V_{CC} = 5.5\text{V}$, $V_E = 2.0\text{V}$			-1.6	mA
V_{EH}	High Level Enable Voltage	$V_{CC} = 5.5\text{V}$, $I_F = 10\text{mA}$	2.0			V
V_{EL}	Low Level Enable Voltage	$V_{CC} = 5.5\text{V}$, $I_F = 10\text{mA}^{(2)}$			0.8	V

Switching Characteristics ($T_A = -40^\circ\text{C}$ to $+85^\circ\text{C}$, $V_{CC} = 5\text{V}$, $I_F = 7.5\text{mA}$ unless otherwise specified.)

Symbol	AC Characteristics	Test Conditions	Device	Min.	Typ.	Max.	Unit
T_{PLH}	Propagation Delay Time to Output High Level	$R_L = 350\Omega$, $C_L = 15\text{pF}^{(3)}$ (Fig. 20) $T_A = 25^\circ\text{C}$	All	20		75	ns
						100	
T_{PHL}	Propagation Delay Time to Output Low Level	$R_L = 350\Omega$, $C_L = 15\text{pF}^{(4)}$ (Fig. 20) $T_A = 25^\circ\text{C}$	All	25		75	ns
						100	
$ T_{PHL} - T_{PLH} $	Pulse Width Distortion	$R_L = 350\Omega$, $C_L = 15\text{pF}$ (Fig. 20)	All			35	ns
t_r	Output Rise Time (10-90%)	$R_L = 350\Omega$, $C_L = 15\text{pF}^{(5)}$ (Fig. 20)	Single Ch		50		ns
			Dual Ch		17		
t_f	Output Fall Time (90-10%)	$R_L = 350\Omega$, $C_L = 15\text{pF}^{(6)}$ (Fig. 20)	Single Ch		12		ns
			Dual Ch		5		
t_{ELH}	Enable Propagation Delay Time to Output High Level	$I_F = 7.5\text{mA}$, $V_{EH} = 3.5\text{V}$, $R_L = 350\Omega$, $C_L = 15\text{pF}^{(7)}$ (Fig. 21)	HCPL0600 HCPL0601 HCPL0611		20		ns
t_{EHL}	Enable Propagation Delay Time to Output Low Level	$I_F = 7.5\text{mA}$, $V_{EH} = 3.5\text{V}$, $R_L = 350\Omega$, $C_L = 15\text{pF}^{(8)}$ (Fig. 21)	HCPL0600 HCPL0601 HCPL0611		20		ns
ICM_{Hl}	Common Mode Transient Immunity (at Output High Level)	$R_L = 350\Omega$, $T_A = 25^\circ\text{C}$, $I_F = 0\text{mA}$, V_{OH} (Min.) = $2.0\text{V}^{(9)}$ (Fig. 22, 23)	$ V_{CM} = 10\text{V}$	HCPL0600 HCPL0637	5,000		V/ μs
			$ V_{CM} = 50\text{V}$	HCPL0601 HCPL0638	10,000		
			$ V_{CM} = 1,000\text{V}$	HCPL0611	15,000		
				HCPL0639	25,000		
ICM_{Ll}	Common Mode Transient Immunity (at Output Low Level)	$R_L = 350\Omega$, $T_A = 25^\circ\text{C}$, $I_F = 7.5\text{mA}$, V_{OL} (Max.) = $0.8\text{V}^{(10)}$ (Fig. 22, 23)	$ V_{CM} = 10\text{V}$	HCPL0600 HCPL0637	5,000		V/ μs
			$ V_{CM} = 50\text{V}$	HCPL0601 HCPL0638	10,000		
			$ V_{CM} = 1,000\text{V}$	HCPL0611	15,000		
				HCPL0639	25,000		

Transfer Characteristics ($T_A = -40^{\circ}\text{C}$ to $+85^{\circ}\text{C}$ unless otherwise specified.)

Symbol	DC Characteristics	Test Conditions	Min.	Typ.*	Max.	Unit
I_{OH}	High Level Output Current	$V_{CC} = 5.5\text{V}$, $V_O = 5.5\text{V}$, $I_F = 250\mu\text{A}$, $V_E = 2.0\text{V}^{(2)}$			100	μA
V_{OL}	Low Level Output Voltage	$V_{CC} = 5.5\text{V}$, $I_F = 5\text{mA}$, $V_E = 2.0\text{V}$, $I_{OL} = 13\text{mA}^{(2)}$			0.6	V
I_{FT}	Input Threshold Current	$V_{CC} = 5.5\text{V}$, $V_O = 0.6\text{V}$, $V_E = 2.0\text{V}$, $I_{OL} = 13\text{mA}$			5	mA

Isolation Characteristics ($T_A = -40^{\circ}\text{C}$ to $+85^{\circ}\text{C}$ unless otherwise specified.)

Symbol	Characteristics	Test Conditions	Min.	Typ.*	Max.	Unit
I_{I-O}	Input-Output Insulation Leakage Current	Relative humidity = 45%, $T_A = 25^{\circ}\text{C}$, $t = 5\text{s}$, $V_{I-O} = 3000\text{VDC}^{(11)}$			1.0*	μA
V_{ISO}	Withstand Insulation Test Voltage	$R_H < 50\%$, $T_A = 25^{\circ}\text{C}$, $I_{I-O} \leq 2\mu\text{A}$, $t = 1\text{min.}^{(11)}$	3750			V_{RMS}
R_{I-O}	Resistance (Input to Output)	$V_{I-O} = 500\text{V}^{(11)}$		10^{12}		Ω
C_{I-O}	Capacitance (Input to Output)	$f = 1\text{MHz}^{(11)}$		0.6		pF

*All typical values are at $V_{CC} = 5\text{V}$, $T_A = 25^{\circ}\text{C}$

Notes:

1. The V_{CC} supply to each optoisolator must be bypassed by a $0.1\mu\text{F}$ capacitor or larger. This can be either a ceramic or solid tantalum capacitor with good high frequency characteristic and should be connected as close as possible to the package V_{CC} and GND pins of each device.
2. Enable Input – No pull up resistor required as the device has an internal pull up resistor.
3. t_{PLH} – Propagation delay is measured from the 3.75mA level on the HIGH to LOW transition of the input current pulse to the 1.5V level on the LOW to HIGH transition of the output voltage pulse.
4. t_{PHL} – Propagation delay is measured from the 3.75mA level on the LOW to HIGH transition of the input current pulse to the 1.5V level on the HIGH to LOW transition of the output voltage pulse.
5. t_r – Rise time is measured from the 90% to the 10% levels on the LOW to HIGH transition of the output pulse.
6. t_f – Fall time is measured from the 10% to the 90% levels on the HIGH to LOW transition of the output pulse.
7. t_{ELH} – Enable input propagation delay is measured from the 1.5V level on the HIGH to LOW transition of the input voltage pulse to the 1.5V level on the LOW to HIGH transition of the output voltage pulse.
8. t_{EHL} – Enable input propagation delay is measured from the 1.5V level on the LOW to HIGH transition of the input voltage pulse to the 1.5V level on the HIGH to LOW transition of the output voltage pulse.
9. CM_H – The maximum tolerable rate of rise of the common mode voltage to ensure the output will remain in the high state (i.e., $V_{OUT} > 2.0\text{V}$). Measured in volts per microsecond ($\text{V}/\mu\text{s}$).
10. CM_L – The maximum tolerable rate of fall of the common mode voltage to ensure the output will remain in the low output state (i.e., $V_{OUT} < 0.8\text{V}$). Measured in volts per microsecond ($\text{V}/\mu\text{s}$).
11. Device considered a two-terminal device: Pins 1, 2, 3 and 4 shorted together, and Pins 5, 6, 7 and 8 shorted together.

Typical Performance Curves (HCPL0600, HCPL0601 and HCPL0611 only)

Fig. 1 Forward Current vs. Input Forward Voltage

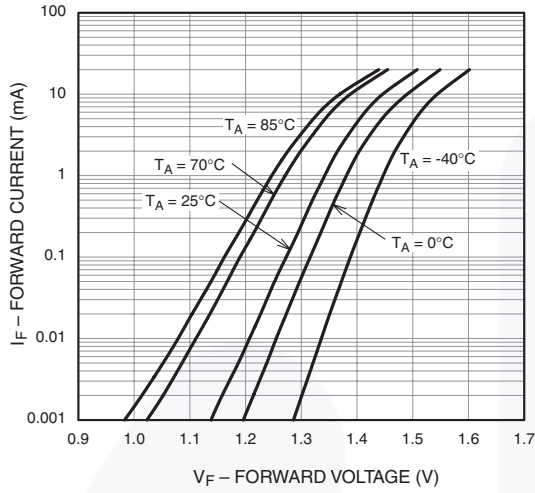

Fig. 2 Output Voltage vs. Forward Current

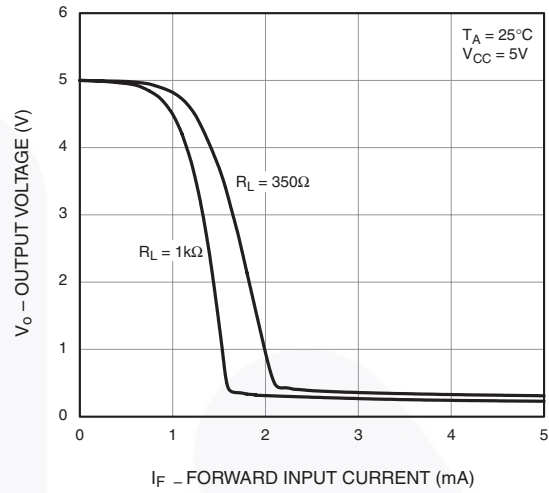

Fig. 3 Input Threshold Current vs. Temperature

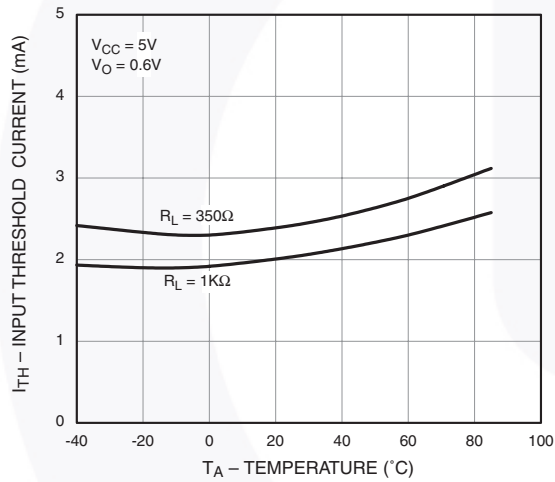
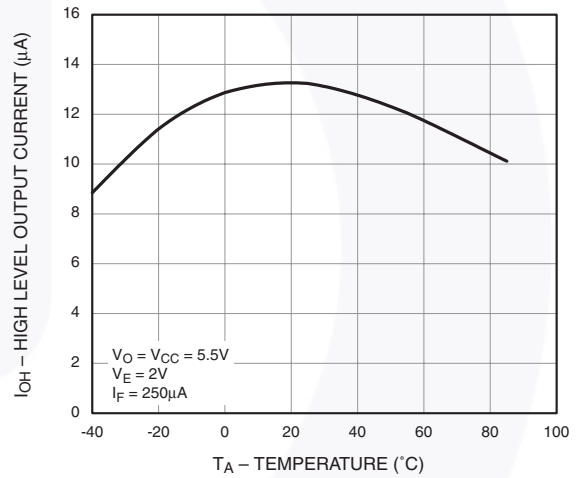

Fig. 4 High Level Output Current vs. Temperature



Typical Performance Curves (HCPL0600, HCPL0601 and HCPL0611 only)

Fig. 5 Low Level Output Voltage vs. Temperature

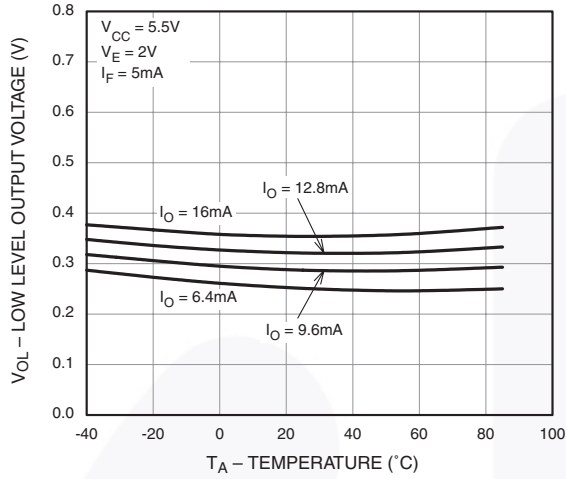

Fig. 6 Low Level Output Current vs. Temperature

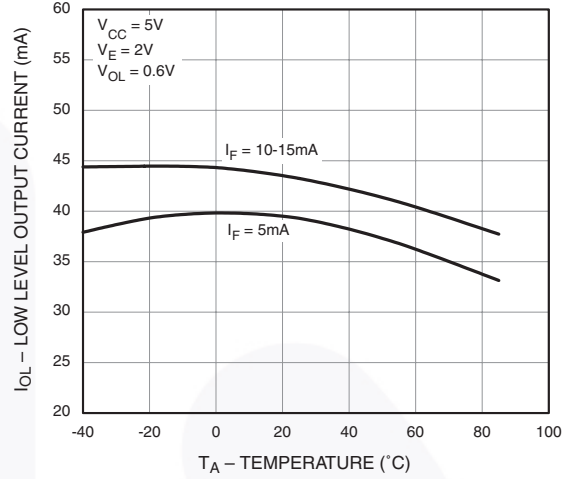
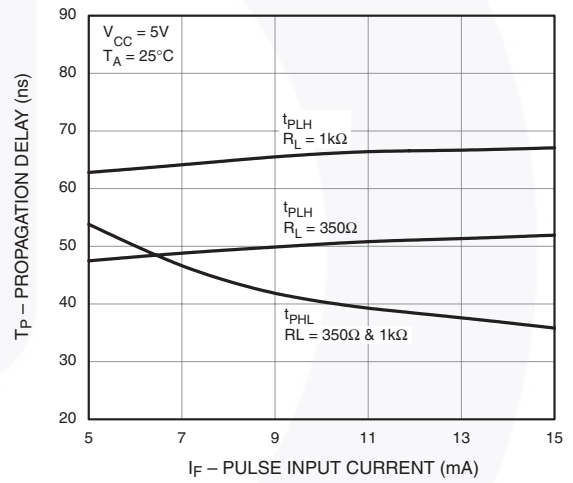

Fig. 7 Propagation Delay vs. Temperature



Fig. 8 Propagation Delay vs. Pulse Input Current



Typical Performance Curves (HCPL0600, HCPL0601 and HCPL0611 only)

Fig. 9 Typical Enable Propagation Delay vs. Temperature

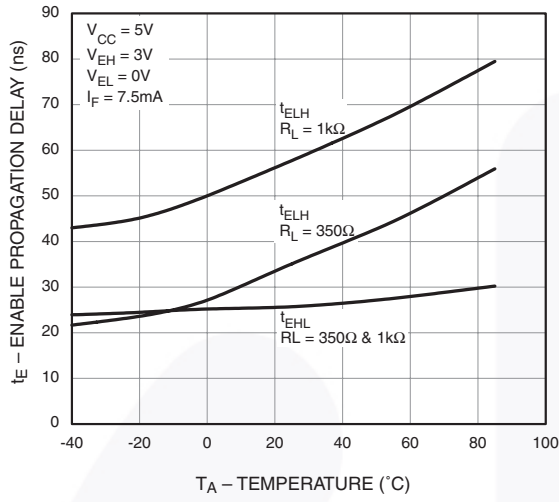

Fig. 10 Typical Rise and Fall Time vs. Temperature

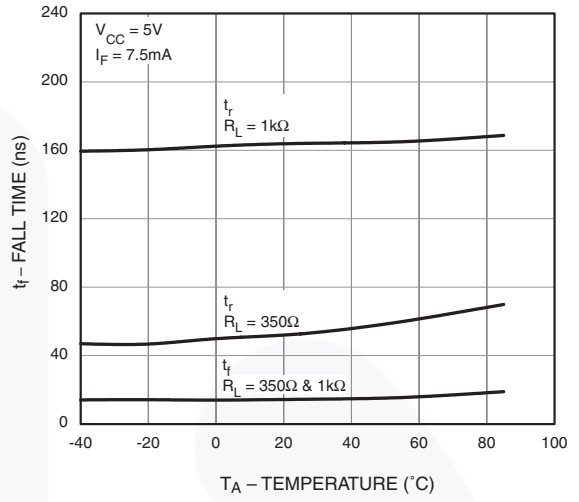
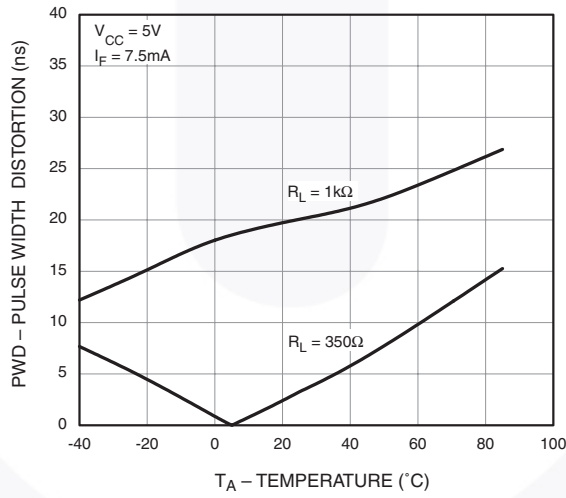

Fig. 11 Typical Pulse Width Distortion vs. Temperature



Typical Performance Curves (HCPL0637, HCPL0638 and HCPL0639 only)

Fig. 12 Input Forward Current vs. Forward Voltage



Fig. 13 Input Threshold Current vs. Ambient Temperature

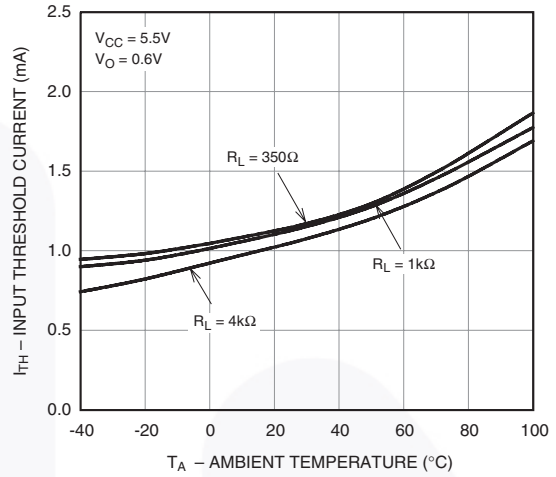

Fig. 14 High Level Output Current vs. Ambient Temperature

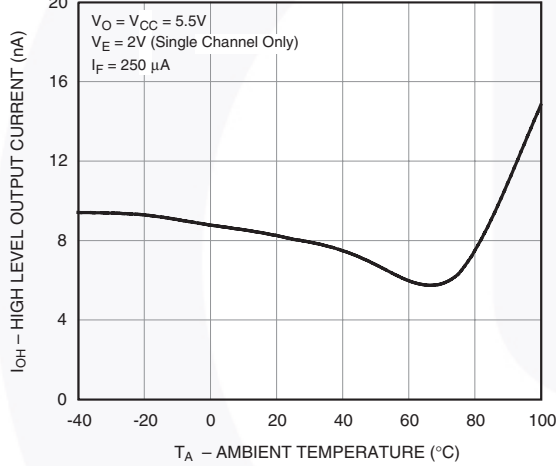

Fig. 15 Low Level Output Current vs. Ambient Temperature

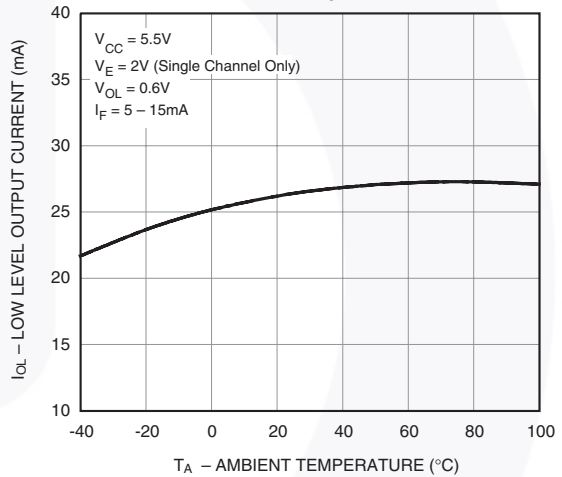

Fig. 16 Low Level Output Voltage vs. Ambient Temperature

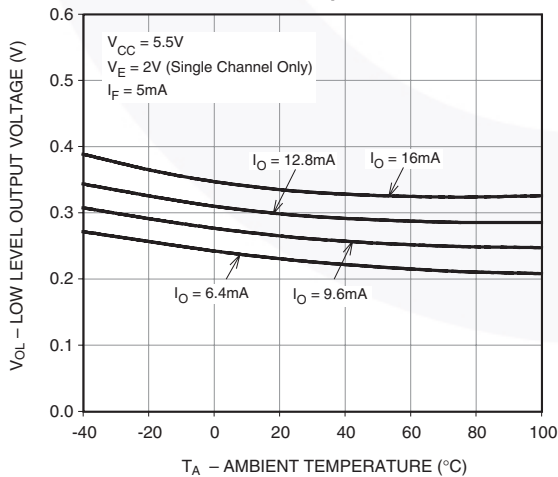
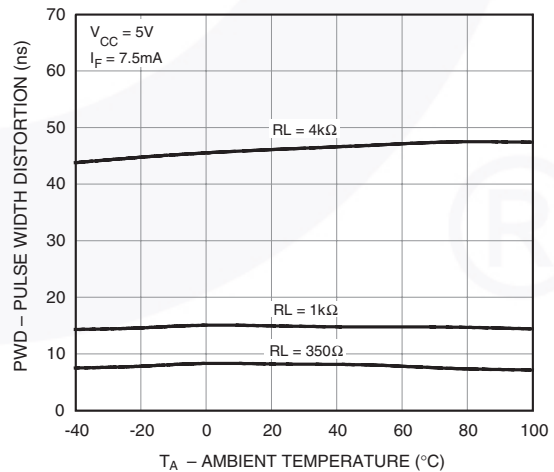

Fig. 17 Pulse Width Distortion vs. Ambient Temperature



Typical Performance Curves (HCPL0637, HCPL0638 and HCPL0639 only)

Fig. 18 Propagation Delay vs. Ambient Temperature



Fig. 19 Rise and Fall Times vs. Ambient Temperature





Fig. 20 Test Circuit and Waveforms for t_{PLH} , t_{PHL} , t_r and t_f .

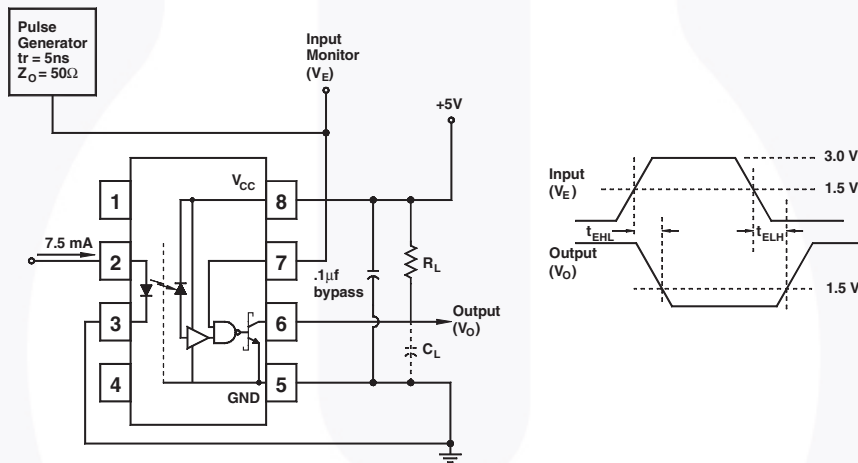

Fig. 21 Test Circuit t_{EHL} and t_{ELH} .



Test Circuit for HCPL0600, HCPL0601, and HCPL0611

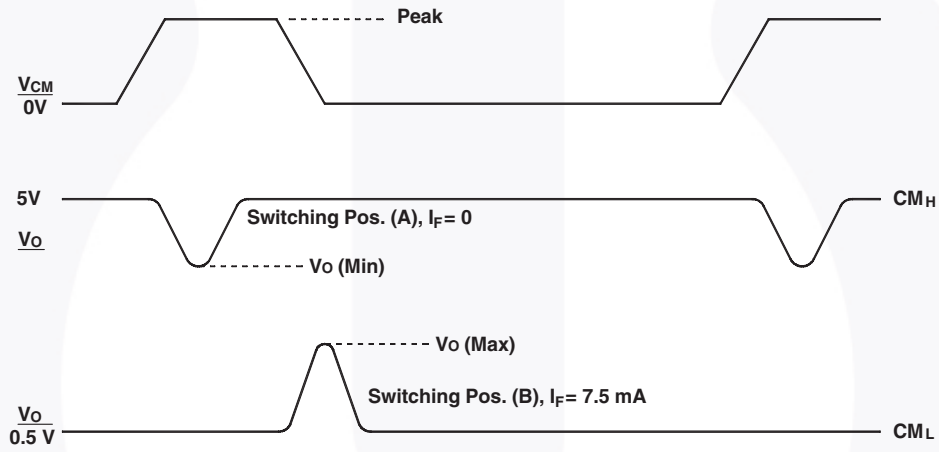
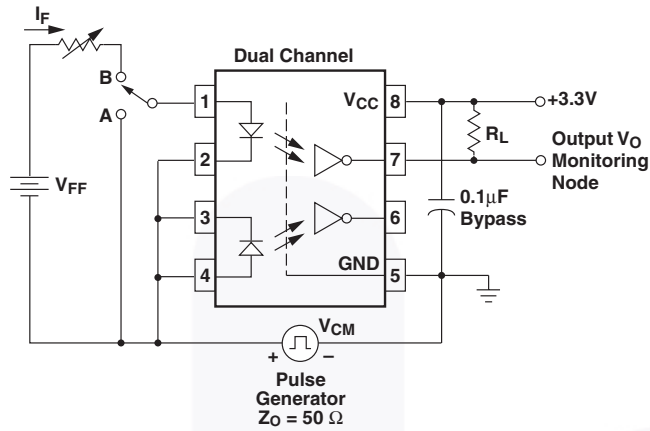

Fig. 22 Test Circuit Common Mode Transient Immunity (HCPL0600, HCPL0601 and HCPL0611)



Test Circuit for HCPL0637, HCPL0638 and HCPL0639



Fig. 23 Test Circuit Common Mode Transient Immunity (HCPL0637, HCPL0638 and HCPL0639)

8-Pin Small Outline

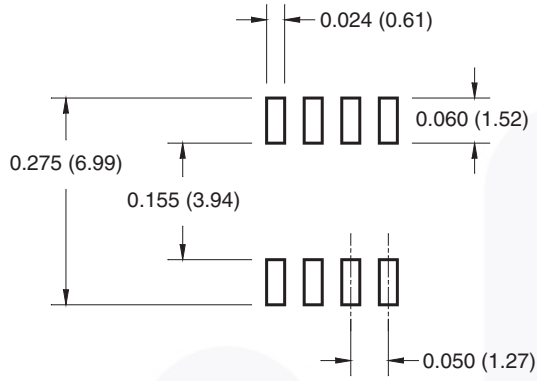

Ordering Information

Option	Order Entry Identifier	Description
No Suffix	HCPL0600	Shipped in tubes (50 units per tube)
V*	HCPL0600V	IEC60747-5-2 approval
R2	HCPL0600R2	Tape and Reel (2500 units per reel)
R2V*	HCPL0600R2V	IEC60747-5-2 approval, Tape and Reel (2500 units per reel)

*Available for HCPL0600, HCPL0601, HCPL0611 only.

Marking Information



Definitions	
1	Fairchild logo
2	Device number
3	VDE mark indicates IEC60747-5-2 approval (Note: Only appears on parts ordered with VDE option – See order entry table)
4	One digit year code, e.g., '3'
5	Two digit work week ranging from '01' to '53'
6	Assembly package code

Carrier Tape Specifications



Reflow Profile

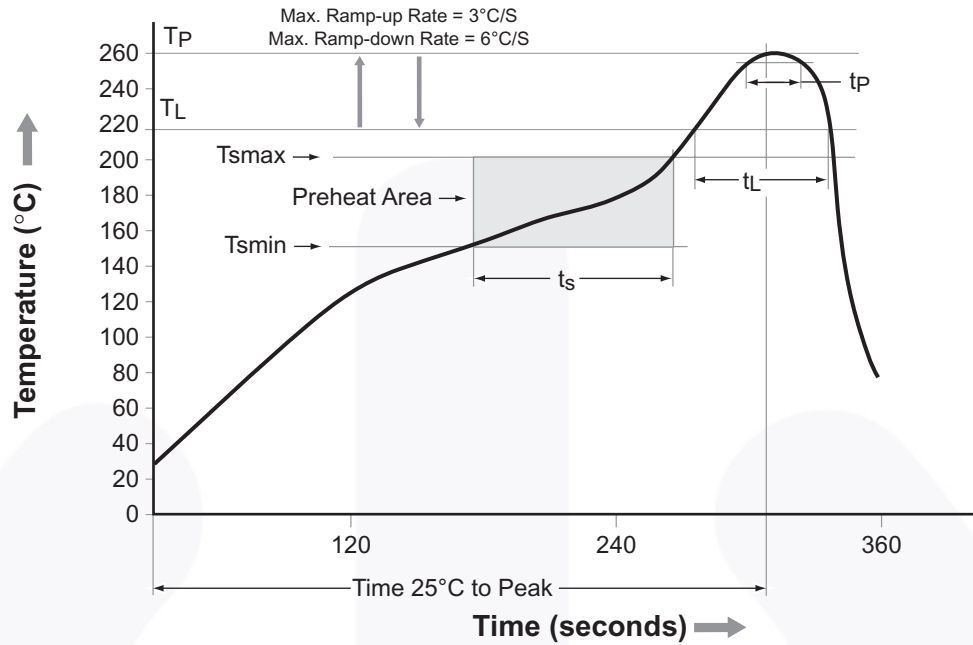

Profile Feature	Pb-Free Assembly Profile
Temperature Min. (T _{smin})	150°C
Temperature Max. (T _{smax})	200°C
Time (t _s) from (T _{smin} to T _{smax})	60–120 seconds
Ramp-up Rate (t _L to t _p)	3°C/second max.
Liquidous Temperature (T _L)	217°C
Time (t _L) Maintained Above (T _L)	60–150 seconds
Peak Body Package Temperature	260°C +0°C / -5°C
Time (t _p) within 5°C of 260°C	30 seconds
Ramp-down Rate (T _P to T _L)	6°C/second max.
Time 25°C to Peak Temperature	8 minutes max.



NOTES:

- A) NO STANDARD APPLIES TO THIS PACKAGE
- B) ALL DIMENSIONS ARE IN MILLIMETERS.
- C) DIMENSIONS DO NOT INCLUDE MOLD FLASH OR BURRS.
- D) LANDPATTERN STANDARD: SOIC127P600X175-8M.
- E) DRAWING FILENAME: MKT-M08Erev5



ON Semiconductor and  are trademarks of Semiconductor Components Industries, LLC dba ON Semiconductor or its subsidiaries in the United States and/or other countries. ON Semiconductor owns the rights to a number of patents, trademarks, copyrights, trade secrets, and other intellectual property. A listing of ON Semiconductor's product/patent coverage may be accessed at www.onsemi.com/site/pdf/Patent-Marking.pdf. ON Semiconductor reserves the right to make changes without further notice to any products herein. ON Semiconductor makes no warranty, representation or guarantee regarding the suitability of its products for any particular purpose, nor does ON Semiconductor assume any liability arising out of the application or use of any product or circuit, and specifically disclaims any and all liability, including without limitation special, consequential or incidental damages. Buyer is responsible for its products and applications using ON Semiconductor products, including compliance with all laws, regulations and safety requirements or standards, regardless of any support or applications information provided by ON Semiconductor. "Typical" parameters which may be provided in ON Semiconductor data sheets and/or specifications can and do vary in different applications and actual performance may vary over time. All operating parameters, including "Typicals" must be validated for each customer application by customer's technical experts. ON Semiconductor does not convey any license under its patent rights nor the rights of others. ON Semiconductor products are not designed, intended, or authorized for use as a critical component in life support systems or any FDA Class 3 medical devices or medical devices with a same or similar classification in a foreign jurisdiction or any devices intended for implantation in the human body. Should Buyer purchase or use ON Semiconductor products for any such unintended or unauthorized application, Buyer shall indemnify and hold ON Semiconductor and its officers, employees, subsidiaries, affiliates, and distributors harmless against all claims, costs, damages, and expenses, and reasonable attorney fees arising out of, directly or indirectly, any claim of personal injury or death associated with such unintended or unauthorized use, even if such claim alleges that ON Semiconductor was negligent regarding the design or manufacture of the part. ON Semiconductor is an Equal Opportunity/Affirmative Action Employer. This literature is subject to all applicable copyright laws and is not for resale in any manner.

PUBLICATION ORDERING INFORMATION

LITERATURE FULFILLMENT:

Literature Distribution Center for ON Semiconductor
19521 E. 32nd Pkwy, Aurora, Colorado 80011 USA
Phone: 303-675-2175 or 800-344-3860 Toll Free USA/Canada
Fax: 303-675-2176 or 800-344-3867 Toll Free USA/Canada
Email: orderlit@onsemi.com

N. American Technical Support: 800-282-9855 Toll Free
USA/Canada
Europe, Middle East and Africa Technical Support:
Phone: 421 33 790 2910
Japan Customer Focus Center
Phone: 81-3-5817-1050

ON Semiconductor Website: www.onsemi.com
Order Literature: <http://www.onsemi.com/orderlit>
For additional information, please contact your local
Sales Representative