



Is Now Part of



**ON Semiconductor®**

To learn more about ON Semiconductor, please visit our website at  
[www.onsemi.com](http://www.onsemi.com)

ON Semiconductor and the ON Semiconductor logo are trademarks of Semiconductor Components Industries, LLC dba ON Semiconductor or its subsidiaries in the United States and/or other countries. ON Semiconductor owns the rights to a number of patents, trademarks, copyrights, trade secrets, and other intellectual property. A listing of ON Semiconductor's product/patent coverage may be accessed at [www.onsemi.com/site/pdf/Patent-Marking.pdf](http://www.onsemi.com/site/pdf/Patent-Marking.pdf). ON Semiconductor reserves the right to make changes without further notice to any products herein. ON Semiconductor makes no warranty, representation or guarantee regarding the suitability of its products for any particular purpose, nor does ON Semiconductor assume any liability arising out of the application or use of any product or circuit, and specifically disclaims any and all liability, including without limitation special, consequential or incidental damages. Buyer is responsible for its products and applications using ON Semiconductor products, including compliance with all laws, regulations and safety requirements or standards, regardless of any support or applications information provided by ON Semiconductor. "Typical" parameters which may be provided in ON Semiconductor data sheets and/or specifications can and do vary in different applications and actual performance may vary over time. All operating parameters, including "Typicals" must be validated for each customer application by customer's technical experts. ON Semiconductor does not convey any license under its patent rights nor the rights of others. ON Semiconductor products are not designed, intended, or authorized for use as a critical component in life support systems or any FDA Class 3 medical devices or medical devices with a same or similar classification in a foreign jurisdiction or any devices intended for implantation in the human body. Should Buyer purchase or use ON Semiconductor products for any such unintended or unauthorized application, Buyer shall indemnify and hold ON Semiconductor and its officers, employees, subsidiaries, affiliates, and distributors harmless against all claims, costs, damages, and expenses, and reasonable attorney fees arising out of, directly or indirectly, any claim of personal injury or death associated with such unintended or unauthorized use, even if such claim alleges that ON Semiconductor was negligent regarding the design or manufacture of the part. ON Semiconductor is an Equal Opportunity/Affirmative Action Employer. This literature is subject to all applicable copyright laws and is not for resale in any manner.

# NC7WZ08

## TinyLogic® UHS Dual 2-Input AND Gate

### Features

- Space saving US8 surface mount package
- MicroPak™ leadless package
- Ultra High Speed;  $t_{PD}$  2.5ns Typ. into 50pF at 5V  $V_{CC}$
- High Output Drive;  $\pm 24mA$  at 3V  $V_{CC}$
- Broad  $V_{CC}$  Operating Range; 1.65V to 5.5V
- Matches the performance of LCX when operated at 3.3V  $V_{CC}$
- Power down high impedance inputs/output
- Overvoltage tolerant inputs facilitate 5V to 3V translation
- Patented noise/EMI reduction circuitry implemented

### General Description

The NC7WZ08 is a dual 2-Input AND Gate from Fairchild's Ultra High Speed Series of TinyLogic®. The device is fabricated with advanced CMOS technology to achieve ultra high speed with high output drive while maintaining low static power dissipation over a very broad  $V_{CC}$  operating range. The device is specified to operate over the 1.65V to 5.5V  $V_{CC}$  range. The inputs and output are high impedance when  $V_{CC}$  is 0V. Inputs tolerate voltages up to 7V independent of  $V_{CC}$  operating voltage.

### Ordering Information

| Order Number | Package Number | Product Code Top Mark | Package Description                               | Supplied As               |
|--------------|----------------|-----------------------|---|---------------------------|
| NC7WZ08K8X   | MAB08A         | WZ08                  | 8-Lead US8, JEDEC MO-187, Variation CA 3.1mm Wide | 3k Units on Tape and Reel |
| NC7WZ08L8X   | MAC08A         | X4                    | 8-Lead MicroPak, 1.6 mm Wide                      | 5k Units on Tape and Reel |

Device also available in Tape and Reel. Specify by appending suffix letter "X" to the ordering number.

 All packages are lead free per JEDEC: J-STD-020B standard.

### Connection Diagram

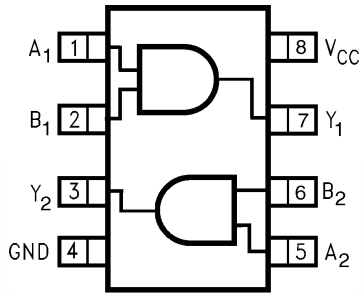

(Top View)

### Pin One Orientation Diagram

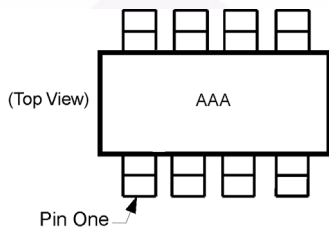

AAA represents Product Code Top Mark – see ordering code

**Note:** Orientation of Top Mark determines Pin One location. Read the top product code mark left to right, Pin One is the lower left pin (see diagram).

### Pad Assignments for MicroPak

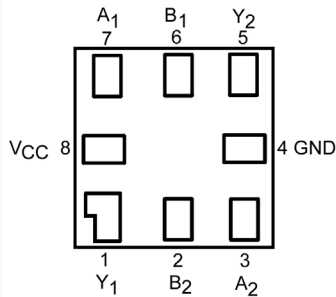

(Top Thru View)

### Logic Symbol

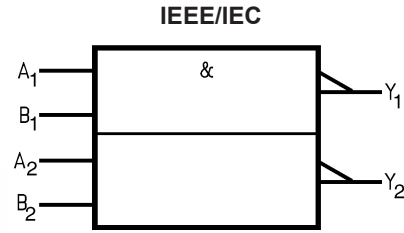

### Function Table

$$Y = AB$$

| Inputs |   | Output |
|--------|---|--------|
| A      | B | Y      |
| L      | L | L      |
| L      | H | L      |
| H      | L | L      |
| H      | H | H      |

H = HIGH Logic Level

L = LOW Logic Level

### Pin Description

| Pin Names  | Description |
|------------|-------------|
| $A_n, B_n$ | Inputs      |
| $Y_n$      | Output      |

## Absolute Maximum Ratings

Stresses exceeding the absolute maximum ratings may damage the device. The device may not function or be operable above the recommended operating conditions and stressing the parts to these levels is not recommended. In addition, extended exposure to stresses above the recommended operating conditions may affect device reliability. The absolute maximum ratings are stress ratings only.

| Symbol           | Parameter   | Rating          |
|------------------|---|-----------------|
| $V_{CC}$         | Supply Voltage                                    | -0.5V to +7V    |
| $V_{IN}$         | DC Input Voltage                                  | -0.5V to +7V    |
| $V_{OUT}$        | DC Output Voltage                                 | -0.5V to +7V    |
| $I_{IK}$         | DC Input Diode Current @ $V_{IN} < -0.5V$         | -50mA           |
| $I_{OK}$         | DC Output Diode Current @ $V_{OUT} < -0.5V$       | -50mA           |
| $I_{OUT}$        | DC Output Current                                 | ±50mA           |
| $I_{CC}/I_{GND}$ | DC $V_{CC}/GND$ Current                           | ±100mA          |
| $T_{STG}$        | Storage Temperature                               | -65°C to +150°C |
| $T_J$            | Junction Temperature Under Bias                   | 150°C           |
| $T_L$            | Junction Lead Temperature (Soldering, 10 seconds) | 260°C           |
| $P_D$            | Power Dissipation @ +85°C<br>US8<br>Micropak-8    | 245mW<br>165mW  |

## Recommended Operating Conditions<sup>(1)</sup>

The Recommended Operating Conditions table defines the conditions for actual device operation. Recommended operating conditions are specified to ensure optimal performance to the datasheet specifications. Fairchild does not recommend exceeding them or designing to absolute maximum ratings.

| Symbol        | Parameter  | Rating          |
|---------------|--|-----------------|
| $V_{CC}$      | Supply Voltage Operating   | 1.65V to 5.5V   |
|               | Supply Voltage Data Retention  | 1.5V to 5.5V    |
| $V_{IN}$      | Input Voltage  | 0V to 5.5V      |
| $V_{OUT}$     | Output Voltage   | 0V to $V_{CC}$  |
| $T_A$         | Operating Temperature  | -40°C to +85°C  |
| $t_r, t_f$    | Input Rise and Fall Time<br>$V_{CC} = 1.8V \pm 0.15V, 2.5V \pm 0.2V$ | 0ns/V to 20ns/V |
|               | $V_{CC} = 3.3V \pm 0.3V$   | 0ns/V to 10ns/V |
|               | $V_{CC} = 5.0V \pm 0.5V$   | 0ns/V to 5ns/V  |
| $\theta_{JA}$ | Thermal Resistance<br>US8  | 265°C/W         |
|               | Micropak-8   | 395°C/W         |

**Note:**

- Unused inputs must be held HIGH or LOW. They may not float.

## DC Electrical Characteristics

| Symbol           | Parameter                 | V <sub>CC</sub> (V) | Conditions                                 |                          | T <sub>A</sub> = 25°C   |      |                        | T <sub>A</sub> = -40°C to +85°C |                        | Units |      |
|------------------|---------------------------|---------------------|--|--------------------------|-------------------------|------|------------------------|---------------------------------|------------------------|-------|------|
|                  |                           |                     |  |                          | Min.                    | Typ. | Max.                   | Min.                            | Max.                   |       |      |
| V <sub>IH</sub>  | HIGH Level Input Voltage  | 1.65–1.95           |  |                          | 0.75 x V <sub>CC</sub>  |      |                        | 0.75 x V <sub>CC</sub>          |                        | V     |      |
|                  |                           | 2.3–5.5             |  |                          | 0.7 x V <sub>CC</sub>   |      |                        | 0.7 x V <sub>CC</sub>           |                        |       |      |
| V <sub>IL</sub>  | LOW Level Input Voltage   | 1.65–1.95           |  |                          |                         |      | 0.25 x V <sub>CC</sub> |                                 | 0.25 x V <sub>CC</sub> | V     |      |
|                  |                           | 2.3–5.5             |  |                          |                         |      | 0.3 x V <sub>CC</sub>  |                                 | 0.3 x V <sub>CC</sub>  |       |      |
| V <sub>OH</sub>  | HIGH Level Output Voltage | 1.65                | V <sub>IN</sub> = V <sub>IH</sub>          | I <sub>OH</sub> = -100μA | 1.55                    | 1.65 |                        | 1.55                            |                        | V     |      |
|                  |                           | 2.3                 |  |                          | 2.2                     | 2.3  |                        | 2.2                             |                        |       |      |
|                  |                           | 3.0                 |  |                          | 2.9                     | 3.0  |                        | 2.9                             |                        |       |      |
|                  |                           | 4.5                 |  |                          | 4.4                     | 4.5  |                        | 4.4                             |                        |       |      |
|                  |                           | 1.65                |  | I <sub>OH</sub> = -4mA   | 1.29                    | 1.52 |                        | 1.29                            |                        |       |      |
|                  |                           | 2.3                 |  |                          | I <sub>OH</sub> = -8mA  | 1.9  | 2.15                   |                                 | 1.9                    |       |      |
|                  |                           | 3.0                 |  |                          | I <sub>OH</sub> = -16mA | 2.5  | 2.80                   |                                 | 2.4                    |       |      |
|                  |                           | 3.0                 |  |                          | I <sub>OH</sub> = -24mA | 2.4  | 2.68                   |                                 | 2.3                    |       |      |
|                  |                           | 4.5                 |  |                          | I <sub>OH</sub> = -32mA | 3.9  | 4.20                   |                                 | 3.8                    |       |      |
|                  |                           |                     |  |                          |                         |      |                        |                                 |                        |       |      |
| V <sub>OL</sub>  | LOW Level Output Voltage  | 1.65                | V <sub>IN</sub> = V <sub>IL</sub>          | I <sub>OL</sub> = 100μA  |                         | 0.0  | 0.1                    |                                 | 0.1                    | V     |      |
|                  |                           | 2.3                 |  |                          |                         | 0.0  | 0.1                    |                                 | 0.1                    |       |      |
|                  |                           | 3.0                 |  |                          |                         | 0.0  | 0.1                    |                                 | 0.1                    |       |      |
|                  |                           | 4.5                 |  |                          |                         | 0.0  | 0.1                    |                                 | 0.1                    |       |      |
|                  |                           | 1.65                |  | I <sub>OL</sub> = 4mA    |                         | 0.08 | 0.24                   |                                 | 0.24                   |       |      |
|                  |                           | 2.3                 |  |                          | I <sub>OL</sub> = 8mA   |      | 0.10                   | 0.3                             |                        |       | 0.3  |
|                  |                           | 3.0                 |  |                          | I <sub>OL</sub> = 16mA  |      | 0.15                   | 0.4                             |                        |       | 0.4  |
|                  |                           | 3.0                 |  |                          | I <sub>OL</sub> = 24mA  |      | 0.22                   | 0.55                            |                        |       | 0.55 |
|                  |                           | 4.5                 |  |                          | I <sub>OL</sub> = 32mA  |      | 0.22                   | 0.55                            |                        |       | 0.55 |
|                  |                           |                     |  |                          |                         |      |                        |                                 |                        |       |      |
| I <sub>IN</sub>  | Input Leakage Current     | 0–5.5               | V <sub>IN</sub> = 5.5V, GND                |                          |                         |      | ±0.1                   |                                 | ±1                     | μA    |      |
| I <sub>OFF</sub> | Power Off Leakage Current | 0.0                 | V <sub>IN</sub> or V <sub>OUT</sub> = 5.5V |                          |                         |      | 1                      |                                 | 10                     | μA    |      |
| I <sub>CC</sub>  | Quiescent Supply Current  | 1.65–5.5            | V <sub>IN</sub> = 5.5V, GND                |                          |                         |      | 1                      |                                 | 10                     | μA    |      |

## AC Electrical Characteristics

| Symbol                              | Parameter                     | V <sub>CC</sub> (V) | Conditions                                      | T <sub>A</sub> = +25°C |      |      | T <sub>A</sub> = -40°C to +85°C |      | Units | Figure Number        |
|-------------------------------------|-------------------------------|---------------------|---|------------------------|------|------|---------------------------------|------|-------|----------------------|
|                                     |                               |                     |   | Min                    | Typ  | Max  | Min                             | Max  |       |                      |
| t <sub>PLH</sub> , t <sub>PHL</sub> | Propagation Delay             | 1.8 ± 0.15          | C <sub>L</sub> = 15pF,<br>R <sub>L</sub> = 1MΩ  | 2.0                    | 5.7  | 10.5 | 2.0                             | 11.0 | ns    | Figure 1<br>Figure 3 |
|                                     |                               | 2.5 ± 0.2           |   | 1.0                    | 3.5  | 5.8  | 1.0                             | 6.2  |       |                      |
|                                     |                               | 3.3 ± 0.3           |   | 0.8                    | 2.6  | 3.9  | 0.8                             | 4.3  |       |                      |
|                                     |                               | 5.0 ± 0.5           |   | 0.5                    | 1.9  | 3.1  | 0.5                             | 3.3  |       |                      |
| t <sub>PLH</sub> , t <sub>PHL</sub> | Propagation Delay             | 3.3 ± 0.3           | C <sub>L</sub> = 50pF,<br>R <sub>L</sub> = 500Ω | 1.2                    | 3.2  | 4.8  | 1.2                             | 5.2  | ns    | Figure 1<br>Figure 3 |
|                                     |                               | 5.0 ± 0.5           |   | 0.8                    | 2.5  | 3.7  | 0.8                             | 4.0  |       |                      |
| C <sub>IN</sub>                     | Input Capacitance             | 0                   |   |                        | 2.5  |      |                                 |      | pF    |                      |
| C <sub>PD</sub>                     | Power Dissipation Capacitance | 3.3                 | (2)   |                        | 14.5 |      |                                 |      | pF    | Figure 2             |
|                                     |                               | 5.0                 |   |                        | 19.5 |      |                                 |      |       |                      |

**Note:**

2. C<sub>PD</sub> is defined as the value of the internal equivalent capacitance which is derived from dynamic operating current consumption (I<sub>CCD</sub>) at no output loading and operating at 50% duty cycle. (See Figure 2.) C<sub>PD</sub> is related to I<sub>CCD</sub> dynamic operating current by the expression: I<sub>CCD</sub> = (C<sub>PD</sub>) (V<sub>CC</sub>) (f<sub>IN</sub>) + (I<sub>CC</sub> static)

## AC Loading and Waveforms

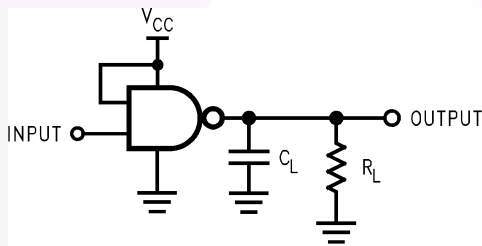

C<sub>L</sub> includes load and stray capacitance  
Input PRR = 1.0MHz, t<sub>w</sub> = 500ns

**Figure 1. AC Test Circuit**

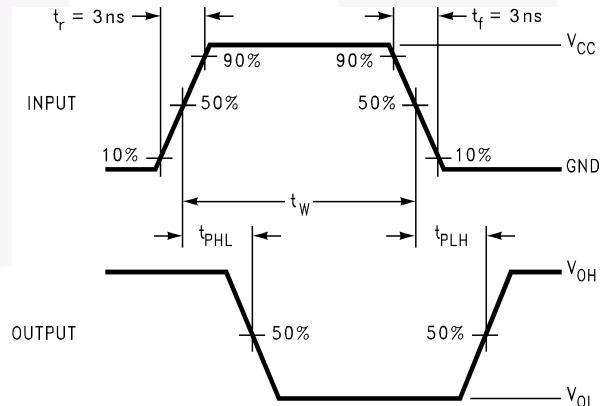

**Figure 3. AC Waveforms**

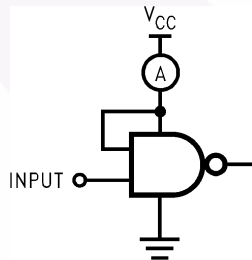

Input = Ac Waveform; t<sub>r</sub> = t<sub>f</sub> = 1.8ns;  
PRR = 10 MHz; Duty Cycle = 50%

**Figure 2. I<sub>CCD</sub> Test Circuit**



**Tape and Reel Specifications** (Continued)

**Reel Dimensions** inches (millimeters)

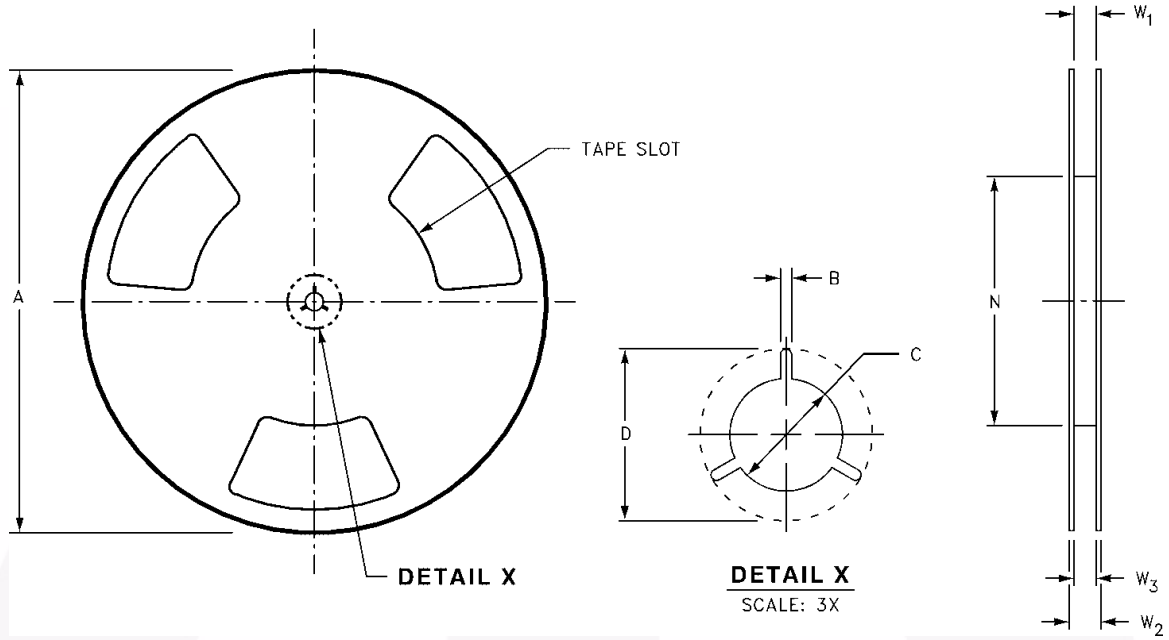

| Tape Size | A              | B               | C                | D                | N                | W1  | W2               | W3                                   |
|-----------|----------------|-----------------|------------------|------------------|------------------|---|------------------|--------------------------------------|
| 8mm       | 7.0<br>(177.8) | 0.059<br>(1.50) | 0.512<br>(13.00) | 0.795<br>(20.20) | 2.165<br>(55.00) | 0.331 +0.059/-0.000<br>(8.40 +1.50/-0.00) | 0.567<br>(14.40) | W1 +0.078/-0.039<br>(W1 +2.00/-1.00) |



## Physical Dimensions

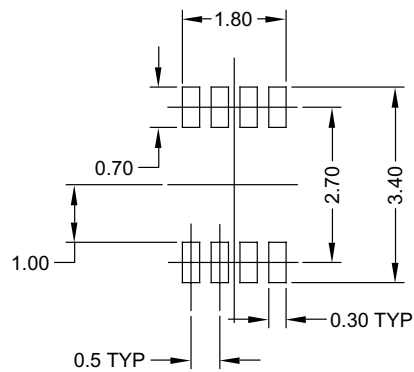
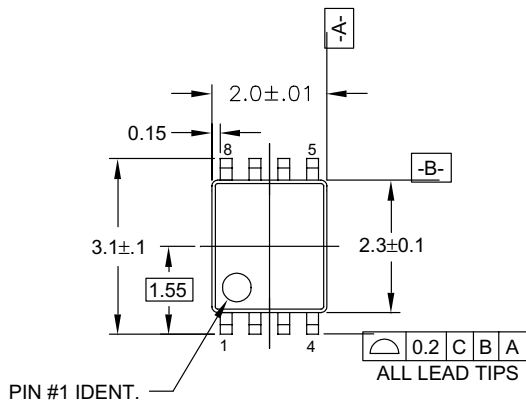

## LAND PATTERN RECOMMENDATION

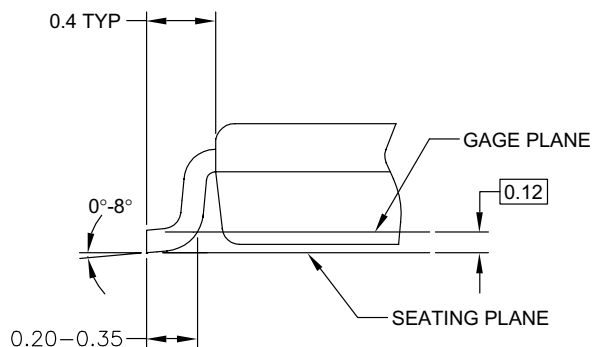
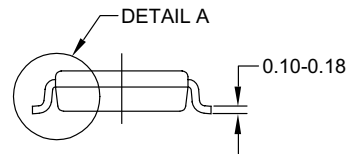
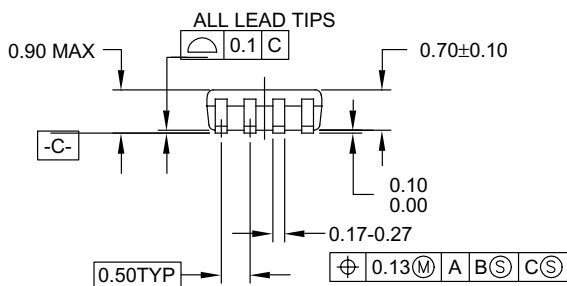

## NOTES:

- A. CONFORMS TO JEDEC REGISTRATION MO-187
- B. DIMENSIONS ARE IN MILLIMETERS.
- C. DIMENSIONS ARE EXCLUSIVE OF BURRS, MOLD FLASH, AND TIE BAR EXTRUSIONS.
- D. DIMENSIONS AND TOLERANCES PER ANSI Y14.5M, 1982.

MAB08AREVC

**Figure 4. 8-Lead US8, JEDEC MO-187, Variation CA 3.1mm Wide**

Package drawings are provided as a service to customers considering Fairchild components. Drawings may change in any manner without notice. Please note the revision and/or date on the drawing and contact a Fairchild Semiconductor representative to verify or obtain the most recent revision. Package specifications do not expand the terms of Fairchild's worldwide terms and conditions, specifically the warranty therein, which covers Fairchild products.

Always visit Fairchild Semiconductor's online packaging area for the most recent package drawings:

<http://www.fairchildsemi.com/packaging/>

**Physical Dimensions** (Continued)

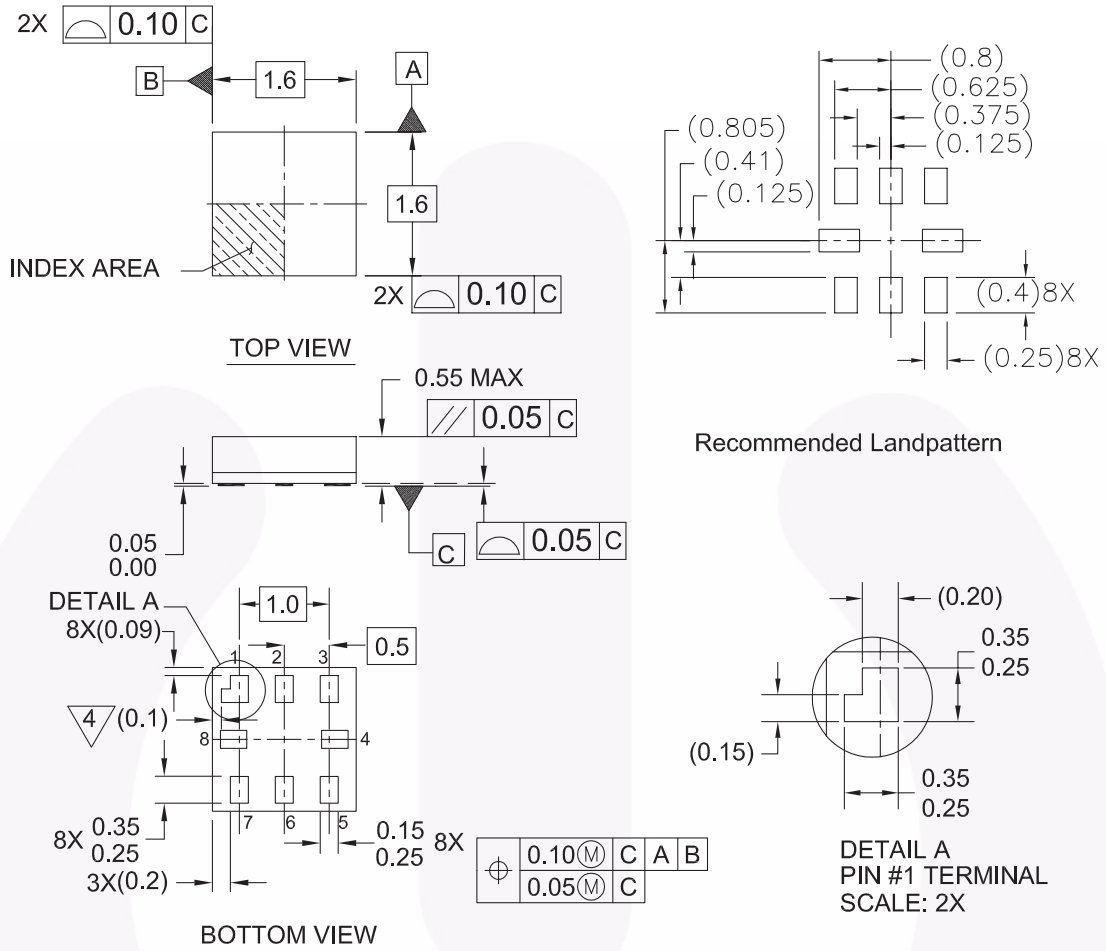

**Notes:**

1. PACKAGE CONFORMS TO JEDEC MO-255 VARIATION UAAD
2. DIMENSIONS ARE IN MILLIMETERS
3. DRAWING CONFORMS TO ASME Y.14M-1994
4. PIN 1 FLAG, END OF PACKAGE OFFSET
5. DRAWING FILE NAME: MKT-MAC08AREV4

MAC08AREV4

**Figure 5. 8-Lead MicroPak, 1.6 mm Wide**

Package drawings are provided as a service to customers considering Fairchild components. Drawings may change in any manner without notice. Please note the revision and/or date on the drawing and contact a Fairchild Semiconductor representative to verify or obtain the most recent revision. Package specifications do not expand the terms of Fairchild's worldwide terms and conditions, specifically the warranty therein, which covers Fairchild products.





Always visit Fairchild Semiconductor's online packaging area for the most recent package drawings:

<http://www.fairchildsemi.com/packaging/>



**TRADEMARKS**

The following includes registered and unregistered trademarks and service marks, owned by Fairchild Semiconductor and/or its global subsidiaries, and is not intended to be an exhaustive list of all such trademarks.

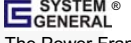
- |   |   |   |   |
|---|---|---|---|
| Build it Now™   | FRFET®  | Programmable Active Droop™  | the power franchise   |
| CorePLUS™   | Global Power Resource <sup>SM</sup>   | QFET®   | TinyBoost™  |
| CorePOWER™  | Green FPS™  | QS™   | TinyBuck™   |
| CROSSVOLT™  | Green FPS™ e-Series™  | Quiet Series™   | TinyLogic™  |
| CTL™  | GTO™  | RapidConfigure™   | TINYOPTO™   |
| Current Transfer Logic™   | IntelliMAX™   |  ™ | TinyPower™  |
| EcoSPARK®   | ISOPLANAR™  | Saving our world, 1mW/W/kW at a time™   | TinyPWM™  |
| EfficientMax™   | MegaBuck™   | SmartMax™   | TinyWire™   |
| EZSWITCH™ *   | MICROCOUPLER™   | SMART START™  | μSerDes™  |
|  ™ | MicroFET™   | SPM®  |  ™ |
|  ™ | MicroPak™   | STEALTH™  | UHC®  |
| Fairchild®  | MillerDrive™  | SuperFET™   | Ultra FRFET™  |
| Fairchild Semiconductor®  | MotionMax™  | SuperSOT™3  | UniFET™   |
| FACT Quiet Series™  | Motion-SPM™   | SuperSOT™6  | VCX™  |
| FACT®   | OPTOLOGIC®  | SuperSOT™8  | VisualMax™  |
| FAST®   | OPTOPLANAR®   | SupreMOS™   | XS™   |
| FastvCore™  |  ™ | SyncFET™  |   |
| FlashWriter® *  | PDP SPM™  |  ™ |   |
| FPS™  | Power-SPM™  | The Power Franchise®  |   |
| F-PFS™  | PowerTrench®  |   |   |
|   | PowerXS™  |   |   |

\* EZSWITCH™ and FlashWriter® are trademarks of System General Corporation, used under license by Fairchild Semiconductor.

**DISCLAIMER**

FAIRCHILD SEMICONDUCTOR RESERVES THE RIGHT TO MAKE CHANGES WITHOUT FURTHER NOTICE TO ANY PRODUCTS HEREIN TO IMPROVE RELIABILITY, FUNCTION, OR DESIGN. FAIRCHILD DOES NOT ASSUME ANY LIABILITY ARISING OUT OF THE APPLICATION OR USE OF ANY PRODUCT OR CIRCUIT DESCRIBED HEREIN; NEITHER DOES IT CONVEY ANY LICENSE UNDER ITS PATENT RIGHTS, NOR THE RIGHTS OF OTHERS. THESE SPECIFICATIONS DO NOT EXPAND THE TERMS OF FAIRCHILD'S WORLDWIDE TERMS AND CONDITIONS, SPECIFICALLY THE WARRANTY THEREIN, WHICH COVERS THESE PRODUCTS.

**LIFE SUPPORT POLICY**

FAIRCHILD'S PRODUCTS ARE NOT AUTHORIZED FOR USE AS CRITICAL COMPONENTS IN LIFE SUPPORT DEVICES OR SYSTEMS WITHOUT THE EXPRESS WRITTEN APPROVAL OF FAIRCHILD SEMICONDUCTOR CORPORATION.

As used herein:

- Life support devices or systems are devices or systems which, (a) are intended for surgical implant into the body or (b) support or sustain life, and (c) whose failure to perform when properly used in accordance with instructions for use provided in the labeling, can be reasonably expected to result in a significant injury of the user.
- A critical component in any component of a life support, device, or system whose failure to perform can be reasonably expected to cause the failure of the life support device or system, or to affect its safety or effectiveness.

**ANTI-COUNTERFEITING POLICY**

Fairchild Semiconductor Corporation's Anti-Counterfeiting Policy. Fairchild's Anti-Counterfeiting Policy is also stated on our external website, [www.fairchildsemi.com](http://www.fairchildsemi.com), under Sales Support.

Counterfeiting of semiconductor parts is a growing problem in the industry. All manufacturers of semiconductor products are experiencing counterfeiting of their parts. Customers who inadvertently purchase counterfeit parts experience many problems such as loss of brand reputation, substandard performance, failed applications, and increased cost of production and manufacturing delays. Fairchild is taking strong measures to protect ourselves and our customers from the proliferation of counterfeit parts. Fairchild strongly encourages customers to purchase Fairchild parts either directly from Fairchild or from Authorized Fairchild Distributors who are listed by country on our web page cited above. Products customers buy either from Fairchild directly or from Authorized Fairchild Distributors are genuine parts, have full traceability, meet Fairchild's quality standards for handling and storage and provide access to Fairchild's full range of up-to-date technical and product information. Fairchild and our Authorized Distributors will stand behind all warranties and will appropriately address any warranty issues that may arise. Fairchild will not provide any warranty coverage or other assistance for parts bought from Unauthorized Sources. Fairchild is committed to combat this global problem and encourage our customers to do their part in stopping this practice by buying direct or from authorized distributors.

**PRODUCT STATUS DEFINITIONS**

**Definition of Terms**

| Datasheet Identification | Product Status        | Definition  |
|--------------------------|-----------------------|---|
| Advance Information      | Formative / In Design | Datasheet contains the design specifications for product development. Specifications may change in any manner without notice.   |
| Preliminary              | First Production      | Datasheet contains preliminary data; supplementary data will be published at a later date. Fairchild Semiconductor reserves the right to make changes at any time without notice to improve design. |
| No Identification Needed | Full Production       | Datasheet contains final specifications. Fairchild Semiconductor reserves the right to make changes at any time without notice to improve the design.   |
| Obsolete                 | Not In Production     | Datasheet contains specifications on a product that is discontinued by Fairchild Semiconductor. The datasheet is for reference information only.  |

Rev. 137

ON Semiconductor and  are trademarks of Semiconductor Components Industries, LLC dba ON Semiconductor or its subsidiaries in the United States and/or other countries. ON Semiconductor owns the rights to a number of patents, trademarks, copyrights, trade secrets, and other intellectual property. A listing of ON Semiconductor's product/patent coverage may be accessed at [www.onsemi.com/site/pdf/Patent-Marking.pdf](http://www.onsemi.com/site/pdf/Patent-Marking.pdf). ON Semiconductor reserves the right to make changes without further notice to any products herein. ON Semiconductor makes no warranty, representation or guarantee regarding the suitability of its products for any particular purpose, nor does ON Semiconductor assume any liability arising out of the application or use of any product or circuit, and specifically disclaims any and all liability, including without limitation special, consequential or incidental damages. Buyer is responsible for its products and applications using ON Semiconductor products, including compliance with all laws, regulations and safety requirements or standards, regardless of any support or applications information provided by ON Semiconductor. "Typical" parameters which may be provided in ON Semiconductor data sheets and/or specifications can and do vary in different applications and actual performance may vary over time. All operating parameters, including "Typicals" must be validated for each customer application by customer's technical experts. ON Semiconductor does not convey any license under its patent rights nor the rights of others. ON Semiconductor products are not designed, intended, or authorized for use as a critical component in life support systems or any FDA Class 3 medical devices or medical devices with a same or similar classification in a foreign jurisdiction or any devices intended for implantation in the human body. Should Buyer purchase or use ON Semiconductor products for any such unintended or unauthorized application, Buyer shall indemnify and hold ON Semiconductor and its officers, employees, subsidiaries, affiliates, and distributors harmless against all claims, costs, damages, and expenses, and reasonable attorney fees arising out of, directly or indirectly, any claim of personal injury or death associated with such unintended or unauthorized use, even if such claim alleges that ON Semiconductor was negligent regarding the design or manufacture of the part. ON Semiconductor is an Equal Opportunity/Affirmative Action Employer. This literature is subject to all applicable copyright laws and is not for resale in any manner.

## PUBLICATION ORDERING INFORMATION

### LITERATURE FULFILLMENT:

Literature Distribution Center for ON Semiconductor  
19521 E. 32nd Pkwy, Aurora, Colorado 80011 USA  
**Phone:** 303-675-2175 or 800-344-3860 Toll Free USA/Canada  
**Fax:** 303-675-2176 or 800-344-3867 Toll Free USA/Canada  
**Email:** [orderlit@onsemi.com](mailto:orderlit@onsemi.com)

**N. American Technical Support:** 800-282-9855 Toll Free  
USA/Canada  
**Europe, Middle East and Africa Technical Support:**  
Phone: 421 33 790 2910  
**Japan Customer Focus Center**  
Phone: 81-3-5817-1050

**ON Semiconductor Website:** [www.onsemi.com](http://www.onsemi.com)  
**Order Literature:** <http://www.onsemi.com/orderlit>  
For additional information, please contact your local  
Sales Representative