

PLEASE CHECK WWW.MOLEX.COM FOR LATEST PART INFORMATION

Part Number: [0548190519](#)
Status: **Active**
Overview: [Consumer USB Products](#)
Description: USB On-The-Go (OTG) Mini-B Receptacle, Right Angle, Through Hole Solder Tails and Shell Tabs, Lead-Free

Documents:

[3D Model](#) [Packaging Specification SPK-54819-001-001 \(PDF\)](#)
[Drawing \(PDF\)](#) [RoHS Certificate of Compliance \(PDF\)](#)
[Product Specification PS-56579-015-001 \(PDF\)](#)

Agency Certification

UL E29179

General

Product Family I/O Connectors
 Series [54819](#)
 Application Wire-to-Board
 Component Type Receptacle
 MolexKits Yes
 Overview [Consumer USB Products](#)
 Product Name USB 2.0, USB OTG (On-The-Go)
 Type Mini-B
 UPC 822348124435

Physical

Circuits (Loaded) 5
 Circuits (maximum) 5
 Color - Resin Black
 Flammability 94V-0
 Gender Receptacle
 Lock to Mating Part Yes
 Material - Metal High Performance Alloy (HPA)
 Material - Plating Mating Gold
 Material - Plating Termination Tin
 Material - Resin High Temperature Thermoplastic
 Net Weight 0.572g
 Orientation Right Angle
 PC Tail Length 1.80mm
 PCB Retention Yes
 PCB Thickness - Recommended 1.00mm
 Packaging Type Tray
 Panel Mount No
 Pitch - Mating Interface 0.80mm
 Plating min - Mating 0.762µm
 Plating min - Termination 1.016µm
 Polarized to Mating Part Yes
 Surface Mount Compatible (SMC) Yes
 Temperature Range - Operating -20°C to +85°C
 Termination Interface: Style Through Hole
 Wire Size AWG N/A

Electrical

Current - Maximum per Contact 1.0A
 Shielded Yes
 Voltage - Maximum 30V

Solder Process Data

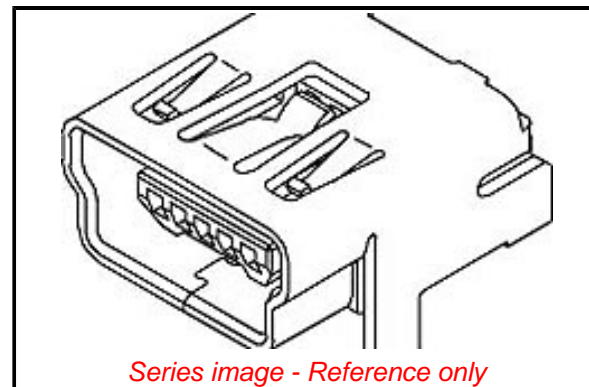

Series image - Reference only

EU ELV

Compliant

EU RoHS

Compliant

REACH SVHC

Not Contained Per -
 ED/21/2016 (20 June
 2016)

Halogen-Free

Status

Not Low-Halogen

Need more information on product environmental compliance?

Email productcompliance@molex.com
 Please visit the [Contact Us](#) section for any non-product compliance questions.

China ROHS

ELV

RoHS Phthalates

Green Image

Compliant

Not Contained

Search Parts in this Series

[54819 Series](#)

Mates With

[59204-9401](#) , [59205-3301](#)

Duration at Max. Process Temperature (seconds)	010
Lead-freeProcess Capability	REFLOW
Max. Cycles at Max. Process Temperature	001
Process Temperature max. C	260

Material Info

Reference - Drawing Numbers

Electrical Model Document	EE-54819-0001
Packaging Specification	SPK-54819-001-001
Product Specification	PS-56579-015-001
S-Parameter Model	SP-54819-67542-0001
Sales Drawing	SD-54819-026

This document was generated on 12/27/2016

PLEASE CHECK WWW.MOLEX.COM FOR LATEST PART INFORMATION