

High Voltage Schottky Diode

- Rectifier Schottky diode for telecommunication and industrial applications
- High reverse voltage: 240 V
- For power supply applications
- For clamping and protection in high voltage applications
- Pb-free (RoHS compliant) package¹⁾
- Qualified according AEC Q101

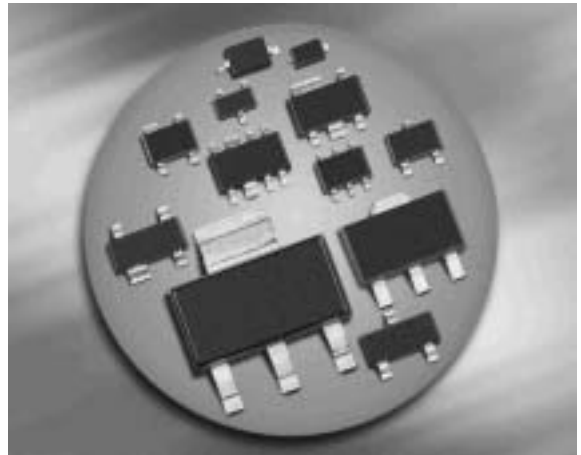

BAT240A

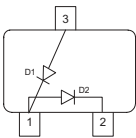

ESD (Electrostatic discharge) sensitive device, observe handling precaution!

Type	Package	Configuration	Marking
BAT240A	SOT23	half bridge	4Ms

Maximum Ratings at $T_A = 25^\circ\text{C}$, unless otherwise specified

Parameter	Symbol	Value	Unit
Diode reverse voltage ²⁾	V_R	240	V
Forward current ²⁾	I_F	400	mA
Non-repetitive peak surge forward current ($t \leq 10\text{ms}$)	I_{FSM}	1	A
Total power dissipation $T_S \leq 28^\circ\text{C}$	P_{tot}	400	mW
Junction temperature	T_j	150	°C
Operating temperature range	T_{op}	-55 ... 125	
Storage temperature	T_{stg}	-55 ... 150	

¹⁾Pb-containing package may be available upon special request

²⁾For $T_A > 25^\circ\text{C}$ the derating of V_R and I_F has to be considered. Please refer to the attached curves.

Thermal Resistance

Parameter	Symbol	Value	Unit
Junction - soldering point ¹⁾	R_{thJS}	≤ 305	K/W

Electrical Characteristics at $T_A = 25^\circ\text{C}$, unless otherwise specified

Parameter	Symbol	Values			Unit
		min.	typ.	max.	

DC Characteristics

Breakdown voltage $I_{(BR)} = 500 \mu\text{A}$	$V_{(BR)}$	240	-	-	V
Reverse current $V_R = 100 \text{ V}$ $V_R = 200 \text{ V}$	I_R	-	1 5	10 -	μA
Forward voltage $I_F = 10 \text{ mA}$ $I_F = 20 \text{ mA}$ $I_F = 50 \text{ mA}$ $I_F = 100 \text{ mA}$ $I_F = 200 \text{ mA}$ $I_F = 400 \text{ mA}$	V_F	0.25 0.29 0.35 - - -	0.325 0.37 0.47 0.58 0.72 0.9	0.36 0.41 0.52 - - -	V

AC Characteristics

Diode capacitance $V_R = 10 \text{ V}, f = 1 \text{ MHz}$ $V_R = 5 \text{ V}, f = 1 \text{ MHz}$	C_T	-	11 15	15 20	pF
--	-------	---	----------	----------	----

¹⁾For calculation of R_{thJA} please refer to Application Note Thermal Resistance

Diode capacitance $C_T = f(V_R)$

$f = 1\text{MHz}$

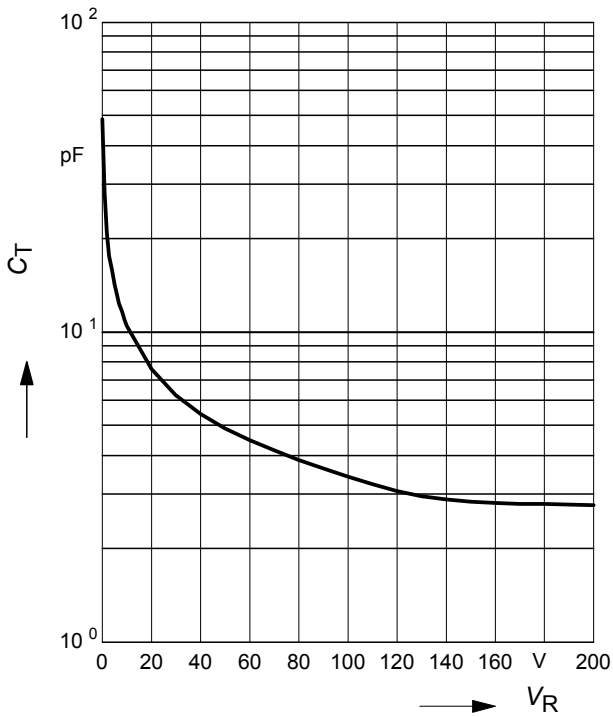

Reverse current $I_R = f(T_A)$

$V_R = \text{Parameter}$

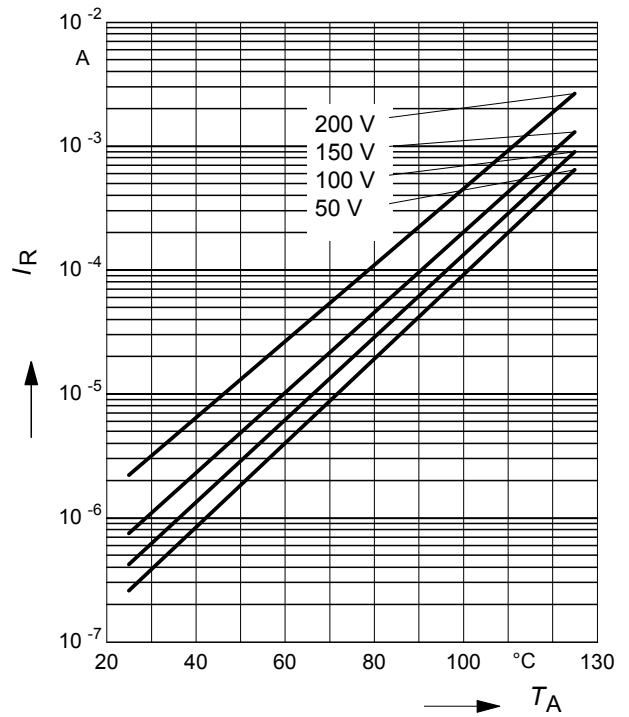

Forward Voltage $V_F = f(T_A)$

$I_F = \text{Parameter}$

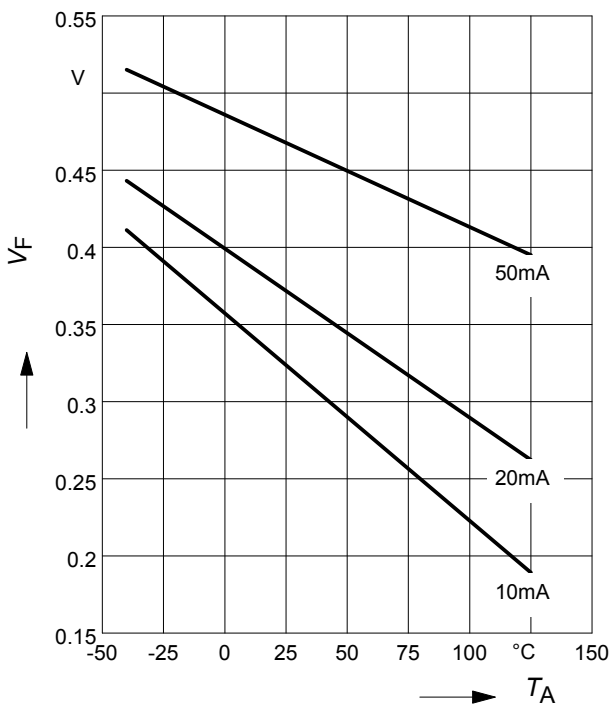

Forward current $I_F = f(V_F)$

$T_A = \text{Parameter}$

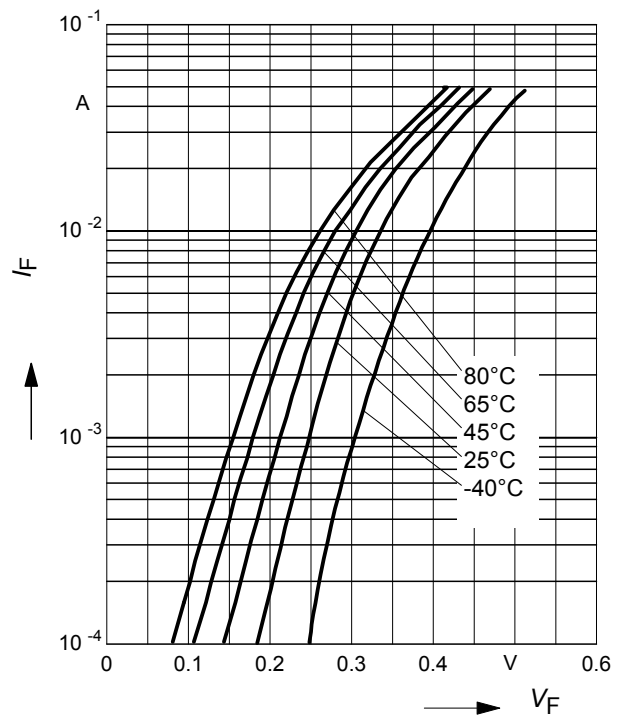

Permissible Reverse voltage $V_R = f(T_A)$

t_p = Parameter, Duty cycle < 0.01

Device mounted on PCB with $R_{th} = 160 \text{ k/W}$

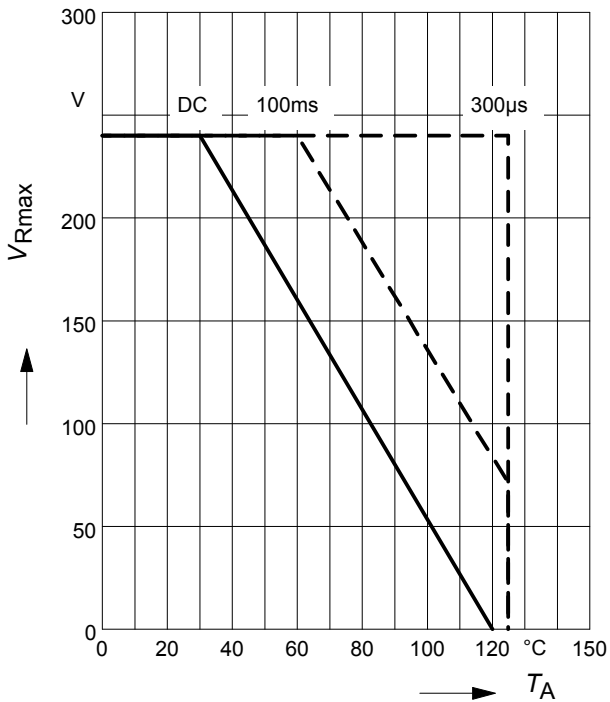

Forward current $I_F = f(T_S)$

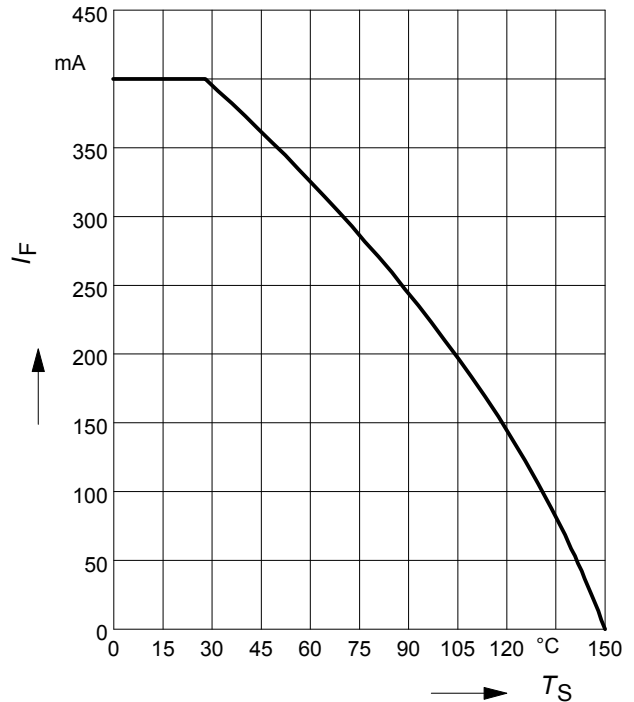

Permissible Puls Load $R_{thJS} = f(t_p)$

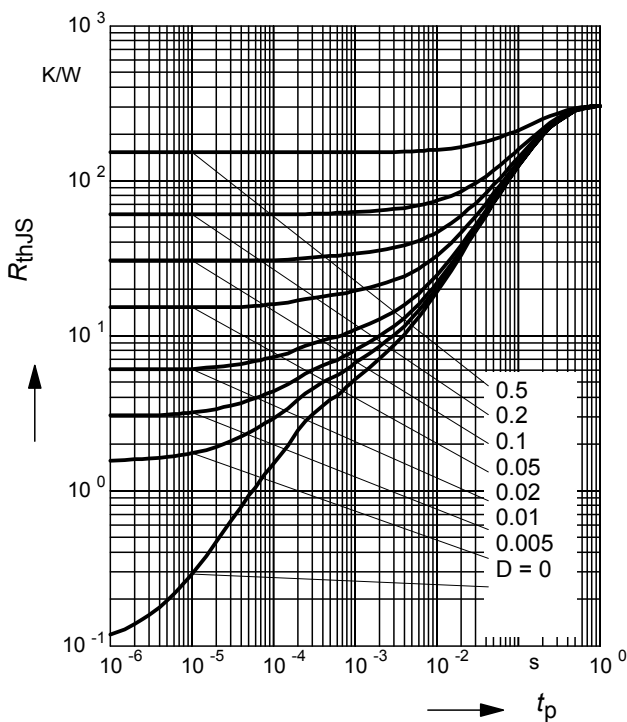

Permissible Pulse Load

$I_{Fmax} / I_{FDC} = f(t_p)$

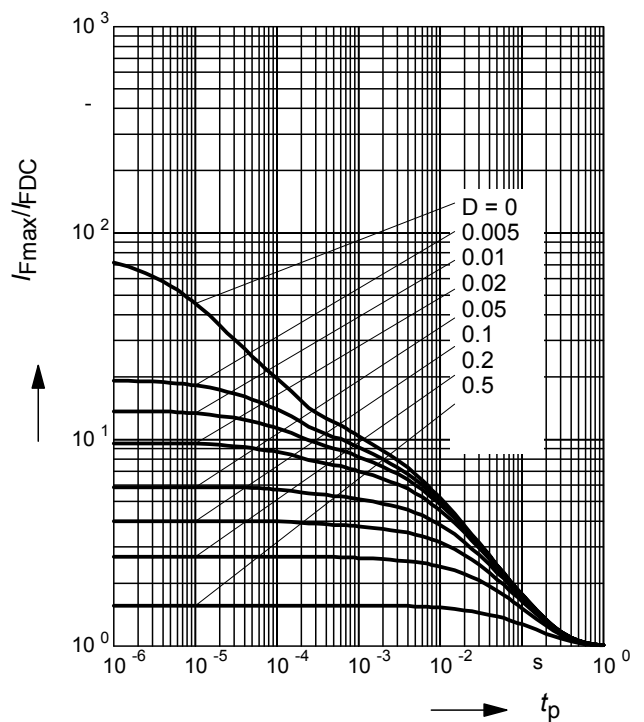

Application example BAT240A

Energy efficient bridge rectification for 110 V / 60 Hz power lines

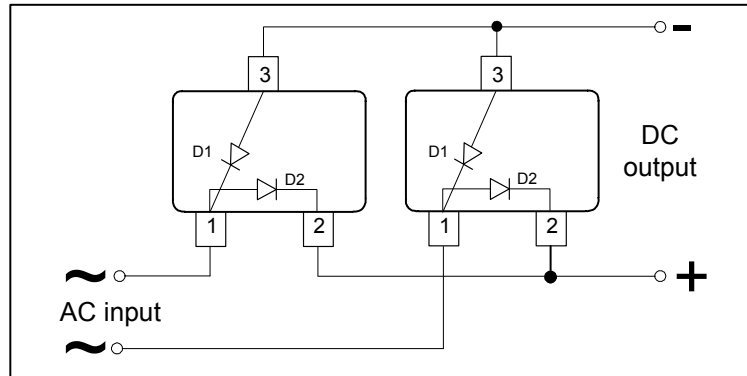

Package Outline

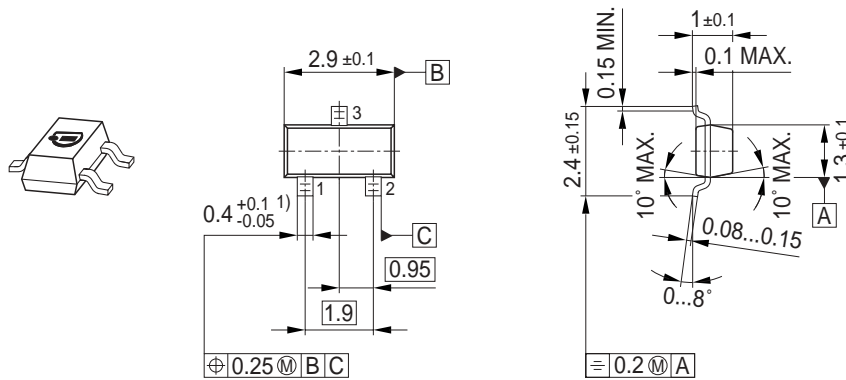

1) Lead width can be 0.6 max. in dambar area

Foot Print

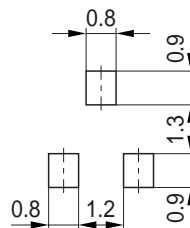

Marking Layout (Example)

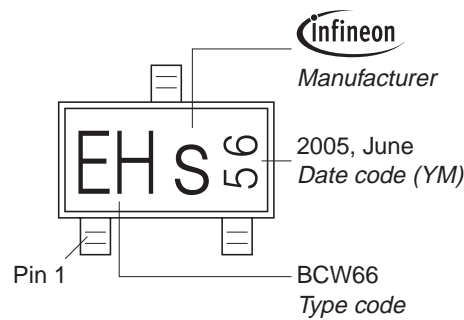

Standard Packing

Reel \varnothing 180 mm = 3.000 Pieces/Reel
 Reel \varnothing 330 mm = 10.000 Pieces/Reel

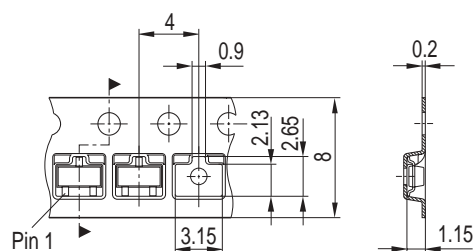

Edition 2006-02-01

Published by

Infineon Technologies AG

81726 München, Germany

© Infineon Technologies AG 2007.

All Rights Reserved.

Attention please!

The information given in this dokument shall in no event be regarded as a guarantee of conditions or characteristics ("Beschaffenheitsgarantie"). With respect to any examples or hints given herein, any typical values stated herein and/or any information regarding the application of the device, Infineon Technologies hereby disclaims any and all warranties and liabilities of any kind, including without limitation warranties of non-infringement of intellectual property rights of any third party.

Information

For further information on technology, delivery terms and conditions and prices please contact your nearest Infineon Technologies Office (www.infineon.com).

Warnings

Due to technical requirements components may contain dangerous substances. For information on the types in question please contact your nearest Infineon Technologies Office.

Infineon Technologies Components may only be used in life-support devices or systems with the express written approval of Infineon Technologies, if a failure of such components can reasonably be expected to cause the failure of that life-support device or system, or to affect the safety or effectiveness of that device or system.

Life support devices or systems are intended to be implanted in the human body, or to support and/or maintain and sustain and/or protect human life. If they fail, it is reasonable to assume that the health of the user or other persons may be endangered.