



Is Now Part of



ON Semiconductor®

To learn more about ON Semiconductor, please visit our website at

www.onsemi.com

ON Semiconductor and the ON Semiconductor logo are trademarks of Semiconductor Components Industries, LLC dba ON Semiconductor or its subsidiaries in the United States and/or other countries. ON Semiconductor owns the rights to a number of patents, trademarks, copyrights, trade secrets, and other intellectual property. A listing of ON Semiconductor's product/patent coverage may be accessed at www.onsemi.com/site/pdf/Patent-Marking.pdf. ON Semiconductor reserves the right to make changes without further notice to any products herein. ON Semiconductor makes no warranty, representation or guarantee regarding the suitability of its products for any particular purpose, nor does ON Semiconductor assume any liability arising out of the application or use of any product or circuit, and specifically disclaims any and all liability, including without limitation special, consequential or incidental damages. Buyer is responsible for its products and applications using ON Semiconductor products, including compliance with all laws, regulations and safety requirements or standards, regardless of any support or applications information provided by ON Semiconductor. "Typical" parameters which may be provided in ON Semiconductor data sheets and/or specifications can and do vary in different applications and actual performance may vary over time. All operating parameters, including "Typicals" must be validated for each customer application by customer's technical experts. ON Semiconductor does not convey any license under its patent rights nor the rights of others. ON Semiconductor products are not designed, intended, or authorized for use as a critical component in life support systems or any FDA Class 3 medical devices or medical devices with a same or similar classification in a foreign jurisdiction or any devices intended for implantation in the human body. Should Buyer purchase or use ON Semiconductor products for any such unintended or unauthorized application, Buyer shall indemnify and hold ON Semiconductor and its officers, employees, subsidiaries, affiliates, and distributors harmless against all claims, costs, damages, and expenses, and reasonable attorney fees arising out of, directly or indirectly, any claim of personal injury or death associated with such unintended or unauthorized use, even if such claim alleges that ON Semiconductor was negligent regarding the design or manufacture of the part. ON Semiconductor is an Equal Opportunity/Affirmative Action Employer. This literature is subject to all applicable copyright laws and is not for resale in any manner.



KA78LXXA / KA78L05AA

3-Terminal 0.1 A Positive Voltage Regulator

Features

- Maximum Output Current of 100 mA
- Output Voltage of 5 V, 6 V, 8 V, 9 V, 10 V, 12 V, 15 V and 18 V
- Thermal Overload Protection
- Short-Circuit Current Limiting
- Output Voltage Offered in $\pm 5\%$ Tolerance

Description

The KA78LXXA / KA78L05AA series of fixed-voltage, monolithic, integrated circuit, voltage regulators are suitable for applications that require supply current up to 100 mA.

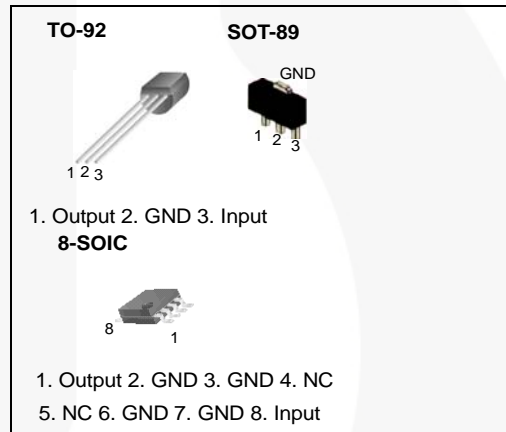

Ordering Information

Product Number	Package	Packing Method	Output Voltage Tolerance	Operating Temperature
KA78L05AZTA	TO-92	Ammo	$\pm 5\%$	-40 to +125 °C
KA78L05AZBU		Bulk		
KA78L06AZTA		Ammo		
KA78L08AZTA		Ammo		
KA78L09AZTA		Ammo		
KA78L10AZTA		Ammo		
KA78L12AZTA		Ammo		
KA78L15AZTA		Ammo		
KA78L18AZTA		Ammo		
KA78L05AMTF		SOT-89		
KA78L08AMTF	Tape & Reel			
KA78L12AMTF	Tape & Reel			
KA78L05ADTF	8-SOIC	Tape & Reel	$\pm 3\%$	0 to +125 °C
KA78L05AAZTA	TO-92	Ammo		

Block Diagram

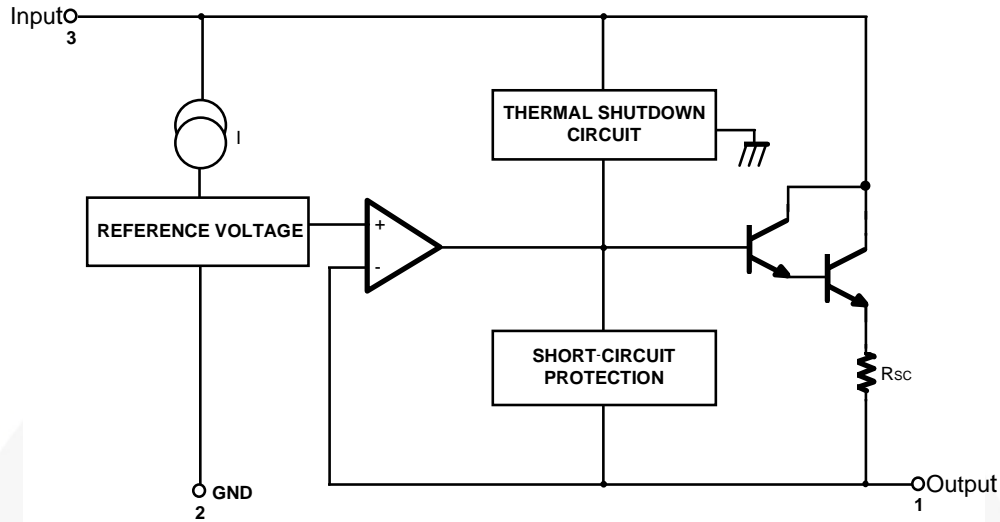

Figure 1. Block Diagram

Absolute Maximum Ratings

Stresses exceeding the absolute maximum ratings may damage the device. The device may not function or be operable above the recommended operating conditions and stressing the parts to these levels is not recommended. In addition, extended exposure to stresses above the recommended operating conditions may affect device reliability. The absolute maximum ratings are stress ratings only. Values are at $T_A = 25^\circ\text{C}$ unless otherwise noted.

Symbol	Parameter		Value	Unit
V_I	Input Voltage	$V_O = 5\text{ V to }8\text{ V}$	30	V
		$V_O = 12\text{ V to }18\text{ V}$	35	V
T_{OPR}	Operating Temperature Range	KA78LXXA	-40 to +125	$^\circ\text{C}$
		KA78L05AA	0 to +125	
$T_{\text{J(MAX)}}$	Maximum Junction Temperature		150	$^\circ\text{C}$
T_{STG}	Storage Temperature Range		-65 to +150	$^\circ\text{C}$
$R_{\theta\text{JC}}$	Thermal Resistance, Junction-Case	TO-92	50	$^\circ\text{C/W}$
		TO-92	150	$^\circ\text{C/W}$
$R_{\theta\text{JA}}$	Thermal Resistance, Junction-Air	SOT-89	225	$^\circ\text{C/W}$
		8-SOIC	160	$^\circ\text{C/W}$

Electrical Characteristics (KA78L05A)

$V_I = 10\text{ V}$, $I_O = 40\text{ mA}$, $-40^\circ\text{C} \leq T_J \leq 125^\circ\text{C}$, $C_I = 0.33\ \mu\text{F}$, $C_O = 0.1\ \mu\text{F}$, unless otherwise specified.

Symbol	Parameter	Conditions	Min.	Typ.	Max.	Unit	
V_O	Output Voltage	$T_J = 25^\circ\text{C}$	4.8	5.0	5.2	V	
ΔV_O	Line Regulation ⁽¹⁾	$T_J = 25^\circ\text{C}$	$7\text{ V} \leq V_I \leq 20\text{ V}$		8	150	mV
			$8\text{ V} \leq V_I \leq 20\text{ V}$		6	100	mV
ΔV_O	Load Regulation ⁽¹⁾	$T_J = 25^\circ\text{C}$	$1\text{ mA} \leq I_O \leq 100\text{ mA}$		11	60	mV
			$1\text{ mA} \leq I_O \leq 40\text{ mA}$		5.0	30	mV
V_O	Output Voltage	$7\text{ V} \leq V_I \leq 20\text{ V}$	$1\text{ mA} \leq I_O \leq 40\text{ mA}$			5.25	V
		$7\text{ V} \leq V_I \leq V_{\text{MAX}}^{(2)}$	$1\text{ mA} \leq I_O \leq 70\text{ mA}$	4.75		5.25	V
I_Q	Quiescent Current	$T_J = 25^\circ\text{C}$		2.0	5.5	mA	
ΔI_Q	Quiescent Current Change	With Line	$8\text{ V} \leq V_I \leq 20\text{ V}$			1.5	mA
ΔI_Q		With Load	$1\text{ mA} \leq I_O \leq 40\text{ mA}$			0.1	mA
V_N	Output Noise Voltage	$T_A = 25^\circ\text{C}$, $10\text{ Hz} \leq f \leq 100\text{ kHz}$		40		$\mu\text{V}/V_O$	
$\Delta V_O/\Delta T$	Temperature Coefficient of V_O	$I_O = 5\text{ mA}$		-0.65		$\text{mV}/^\circ\text{C}$	
RR	Ripple Rejection	$f = 120\text{ Hz}$, $8\text{ V} \leq V_I \leq 18\text{ V}$, $T_J = 25^\circ\text{C}$	41	80		dB	
V_D	Dropout Voltage	$T_J = 25^\circ\text{C}$		1.7		V	

Notes:

- The maximum steady-state usable output current and input voltage are very dependent on the heat sinking and/or lead length of the package. The data above represents pulse test conditions with junction temperature as indicated at the initiation of tests.
- Power dissipation: $P_D \leq 0.75\text{ W}$.

Electrical Characteristics (KA78L06A)

$V_I = 12\text{ V}$, $I_O = 40\text{ mA}$, $-40^\circ\text{C} \leq T_J \leq 125^\circ\text{C}$, $C_I = 0.33\ \mu\text{F}$, $C_O = 0.1\ \mu\text{F}$, unless otherwise specified.

Symbol	Parameter	Conditions	Min.	Typ.	Max.	Unit	
V_O	Output Voltage	$T_J = 25^\circ\text{C}$	5.75	6.00	6.25	V	
ΔV_O	Line Regulation ⁽³⁾	$T_J = 25^\circ\text{C}$	$8.5\text{ V} \leq V_I \leq 20\text{ V}$		64	175	mV
			$9\text{ V} \leq V_I \leq 20\text{ V}$		54	125	mV
ΔV_O	Load Regulation ⁽³⁾	$T_J = 25^\circ\text{C}$	$1\text{ mA} \leq I_O \leq 100\text{ mA}$		12.8	80.0	mV
			$1\text{ mA} \leq I_O \leq 70\text{ mA}$		5.8	40.0	mV
V_O	Output Voltage	$8.5\text{ V} \leq V_I \leq 20\text{ V}$, $1\text{ mA} \leq I_O \leq 40\text{ mA}$			6.3	V	
		$8.5\text{ V} \leq V_I \leq V_{\text{MAX}}^{(4)}$, $1\text{ mA} \leq I_O \leq 70\text{ mA}$	5.7		6.3	V	
I_Q	Quiescent Current	$T_J = 25^\circ\text{C}$			5.5	mA	
		$T_J = 125^\circ\text{C}$		3.9	6.0	mA	
ΔI_Q	Quiescent Current Change	With Line	$9\text{ V} \leq V_I \leq 20\text{ V}$		1.5	mA	
ΔI_Q		With Load	$1\text{ mA} \leq I_O \leq 40\text{ mA}$		0.1	mA	
V_N	Output Noise Voltage	$T_A = 25^\circ\text{C}$, $10\text{ Hz} \leq f \leq 100\text{ kHz}$		40		$\mu\text{V}/V_O$	
$\Delta V_O/\Delta T$	Temperature Coefficient of V_O	$I_O = 5\text{ mA}$		0.75		$\text{mV}/^\circ\text{C}$	
RR	Ripple Rejection	$f = 120\text{ Hz}$, $10\text{ V} \leq V_I \leq 20\text{ V}$, $T_J = 25^\circ\text{C}$	40	46		dB	
V_D	Dropout Voltage	$T_J = 25^\circ\text{C}$		1.7		V	

Notes:

- The maximum steady-state usable output current and input voltage are very dependent on the heat sinking and/or lead length of the package. The data above represents pulse test conditions with junction temperature as indicated at the initiation of tests.
- Power dissipation: $P_D \leq 0.75\text{ W}$.

Electrical Characteristics (KA78L08A)

$V_I = 14\text{ V}$, $I_O = 40\text{ mA}$, $-40^\circ\text{C} \leq T_J \leq 125^\circ\text{C}$, $C_I = 0.33\text{ }\mu\text{F}$, $C_O = 0.1\text{ }\mu\text{F}$, unless otherwise specified.

Symbol	Parameter	Conditions	Min.	Typ.	Max.	Unit	
V_O	Output Voltage	$T_J = 25^\circ\text{C}$	7.7	8.0	8.3	V	
ΔV_O	Line Regulation ⁽⁵⁾	$T_J = 25^\circ\text{C}$	$10.5\text{ V} \leq V_I \leq 23\text{ V}$		10	175	mV
			$11\text{ V} \leq V_I \leq 23\text{ V}$		8	125	mV
ΔV_O	Load Regulation ⁽⁵⁾	$T_J = 25^\circ\text{C}$	$1\text{ mA} \leq I_O \leq 100\text{ mA}$		15	80	mV
			$1\text{ mA} \leq I_O \leq 40\text{ mA}$		8	40	mV
V_O	Output Voltage	$10.5\text{ V} \leq V_I \leq 23\text{ V}$	$1\text{ mA} \leq I_O \leq 40\text{ mA}$	7.6		8.4	V
		$10.5\text{ V} \leq V_I \leq V_{\text{MAX}}^{(6)}$	$1\text{ mA} \leq I_O \leq 70\text{ mA}$	7.6		8.4	V
I_Q	Quiescent Current	$T_J = 25^\circ\text{C}$		2.0	5.5	mA	
ΔI_Q	Quiescent Current Change	With Line	$11\text{ V} \leq V_I \leq 23\text{ V}$		1.5	mA	
ΔI_Q		With Load	$1\text{ mA} \leq I_O \leq 40\text{ mA}$		0.1	mA	
V_N	Output Noise Voltage	$T_A = 25^\circ\text{C}$, $10\text{ Hz} \leq f \leq 100\text{ kHz}$		60		$\mu\text{V}/V_O$	
$\Delta V_O/\Delta T$	Temperature Coefficient of V_O	$I_O = 5\text{ mA}$		-0.8		$\text{mV}/^\circ\text{C}$	
RR	Ripple Rejection	$f = 120\text{ Hz}$, $11\text{ V} \leq V_I \leq 21\text{ V}$, $T_J = 25^\circ\text{C}$	39	70		dB	
V_D	Dropout Voltage	$T_J = 25^\circ\text{C}$		1.7		V	

Notes:

- The maximum steady-state usable output current and input voltage are very dependent on the heat sinking and/or lead length of the package. The data above represents pulse test conditions with junction temperature as indicated at the initiation of tests.
- Power dissipation: $P_D \leq 0.75\text{ W}$.

Electrical Characteristics (KA78L09A)

$V_I = 15\text{ V}$, $I_O = 40\text{ mA}$, $-40^\circ\text{C} \leq T_J \leq 125^\circ\text{C}$, $C_I = 0.33\text{ }\mu\text{F}$, $C_O = 0.1\text{ }\mu\text{F}$, unless otherwise specified.

Symbol	Parameter	Conditions	Min.	Typ.	Max.	Unit	
V_O	Output Voltage	$T_J = 25^\circ\text{C}$	8.64	9.00	9.36	V	
ΔV_O	Line Regulation ⁽⁷⁾	$T_J = 25^\circ\text{C}$	$11.5\text{ V} \leq V_I \leq 24\text{ V}$		90	200	mV
			$13\text{ V} \leq V_I \leq 24\text{ V}$		100	150	mV
ΔV_O	Load Regulation ⁽⁷⁾	$T_J = 25^\circ\text{C}$	$1\text{ mA} \leq I_O \leq 100\text{ mA}$		20	90	mV
			$1\text{ mA} \leq I_O \leq 40\text{ mA}$		10	45	mV
V_O	Output Voltage	$11.5\text{ V} \leq V_I \leq 24\text{ V}$	$1\text{ mA} \leq I_O \leq 40\text{ mA}$	8.55		9.45	V
		$11.5\text{ V} \leq V_I \leq V_{\text{MAX}}^{(8)}$	$1\text{ mA} \leq I_O \leq 70\text{ mA}$	8.55		9.45	V
I_Q	Quiescent Current	$T_J = 25^\circ\text{C}$		2.1	6.0	mA	
ΔI_Q	Quiescent Current Change	With Line	$13\text{ V} \leq V_I \leq 24\text{ V}$		1.5	mA	
ΔI_Q		With Load	$1\text{ mA} \leq I_O \leq 40\text{ mA}$		0.1	mA	
V_N	Output Noise Voltage	$T_A = 25^\circ\text{C}$, $10\text{ Hz} \leq f \leq 100\text{ kHz}$		70		$\mu\text{V}/V_O$	
$\Delta V_O/\Delta T$	Temperature Coefficient of V_O	$I_O = 5\text{ mA}$		-0.9		$\text{mV}/^\circ\text{C}$	
RR	Ripple Rejection	$f = 120\text{ Hz}$, $12\text{ V} \leq V_I \leq 22\text{ V}$, $T_J = 25^\circ\text{C}$	38	44		dB	
V_D	Dropout Voltage	$T_J = 25^\circ\text{C}$		1.7		V	

Notes:

- The maximum steady-state usable output current and input voltage are very dependent on the heat sinking and/or lead length of the package. The data above represents pulse test conditions with junction temperature as indicated at the initiation of tests.
- Power dissipation: $P_D \leq 0.75\text{ W}$.

Electrical Characteristics (KA78L10A)

$V_I = 16\text{ V}$, $I_O = 40\text{ mA}$, $-40\text{ }^\circ\text{C} \leq T_J \leq 125\text{ }^\circ\text{C}$, $C_I = 0.33\text{ }\mu\text{F}$, $C_O = 0.1\text{ }\mu\text{F}$, unless otherwise specified.

Symbol	Parameter	Conditions	Min.	Typ.	Max.	Unit	
V_O	Output Voltage	$T_J = 25\text{ }^\circ\text{C}$	9.6	10.0	10.4	V	
ΔV_O	Line Regulation ⁽⁹⁾	$T_J = 25\text{ }^\circ\text{C}$	$12.5\text{ V} \leq V_I \leq 25\text{ V}$		100	220	mV
			$14\text{ V} \leq V_I \leq 25\text{ V}$		100	170	mV
ΔV_O	Load Regulation ⁽⁹⁾	$T_J = 25\text{ }^\circ\text{C}$	$1\text{ mA} \leq I_O \leq 100\text{ mA}$		20	94	mV
			$1\text{ mA} \leq I_O \leq 70\text{ mA}$		10	47	mV
V_O	Output Voltage	$12.5\text{ V} \leq V_I \leq 25\text{ V}$, $1\text{ mA} \leq I_O \leq 40\text{ mA}$	9.5		10.5	V	
		$12.5\text{ V} \leq V_I \leq V_{MAX}^{(10)}$, $1\text{ mA} \leq I_O \leq 70\text{ mA}$	9.5		10.5		
I_Q	Quiescent Current	$T_J = 25\text{ }^\circ\text{C}$			6.0	mA	
		$T_J = 125\text{ }^\circ\text{C}$		4.2	6.5		
ΔI_Q	Quiescent Current Change	With Line	$12.5\text{ V} \leq V_I \leq 25\text{ V}$		1.5	mA	
ΔI_Q		With Load	$1\text{ mA} \leq I_O \leq 40\text{ mA}$		0.1	mA	
V_N	Output Noise Voltage	$T_A = 25\text{ }^\circ\text{C}$, $10\text{ Hz} \leq f \leq 100\text{ kHz}$		74		$\mu\text{V}/V_O$	
$\Delta V_O/\Delta T$	Temperature Coefficient of V_O	$I_O = 5\text{ mA}$		0.95		$\text{mV}/^\circ\text{C}$	
RR	Ripple Rejection	$f = 120\text{ Hz}$, $15\text{ V} \leq V_I \leq 25\text{ V}$, $T_J = 25\text{ }^\circ\text{C}$	38	43		dB	
V_D	Dropout Voltage	$T_J = 25\text{ }^\circ\text{C}$		1.7		V	

Notes:

9. The maximum steady-state usable output current and input voltage are very dependent on the heat sinking and/or lead length of the package. The data above represents pulse test conditions with junction temperature as indicated at the initiation of tests.
10. Power dissipation: $P_D \leq 0.75\text{ W}$.

Electrical Characteristics (KA78L12A)

$V_I = 19\text{ V}$, $I_O = 40\text{ mA}$, $-40^\circ\text{C} \leq T_J \leq 125^\circ\text{C}$, $C_I = 0.33\text{ }\mu\text{F}$, $C_O = 0.1\text{ }\mu\text{F}$, unless otherwise specified.

Symbol	Parameter	Conditions	Min.	Typ.	Max.	Unit
V_O	Output Voltage	$T_J = 25^\circ\text{C}$	11.5	12.0	12.5	V
ΔV_O	Line Regulation ⁽¹¹⁾	$T_J = 25^\circ\text{C}$	$14.5\text{ V} \leq V_I \leq 27\text{ V}$	20	250	mV
			$16\text{ V} \leq V_I \leq 27\text{ V}$	15	200	mV
ΔV_O	Load Regulation ⁽¹¹⁾	$T_J = 25^\circ\text{C}$	$1\text{ mA} \leq I_O \leq 100\text{ mA}$	20	100	mV
			$1\text{ mA} \leq I_O \leq 40\text{ mA}$	10	50	mV
V_O	Output Voltage	$14.5\text{ V} \leq V_I \leq 27\text{ V}$	$1\text{ mA} \leq I_O \leq 40\text{ mA}$	11.4	12.6	V
		$14.5\text{ V} \leq V_I \leq V_{\text{MAX}}^{(12)}$	$1\text{ mA} \leq I_O \leq 70\text{ mA}$	11.4	12.6	V
I_Q	Quiescent Current	$T_J = 25^\circ\text{C}$		2.1	6.0	mA
ΔI_Q	Quiescent Current Change	With Line	$16\text{ V} \leq V_I \leq 27\text{ V}$		1.5	mA
ΔI_Q		With Load	$1\text{ mA} \leq I_O \leq 40\text{ mA}$		0.1	mA
V_N	Output Noise Voltage	$T_A = 25^\circ\text{C}$, $10\text{ Hz} \leq f \leq 100\text{ kHz}$		80		$\mu\text{V}/V_o$
$\Delta V_O/\Delta T$	Temperature Coefficient of V_O	$I_O = 5\text{ mA}$		-1.0		$\text{mV}/^\circ\text{C}$
RR	Ripple Rejection	$f = 120\text{ Hz}$, $15\text{ V} \leq V_I \leq 25\text{ V}$, $T_J = 25^\circ\text{C}$	37	65		dB
V_D	Dropout Voltage	$T_J = 25^\circ\text{C}$		1.7		V

Notes:

11. The maximum steady-state usable output current and input voltage are very dependent on the heat sinking and/or lead length of the package. The data above represents pulse test conditions with junction temperature as indicated at the initiation of tests.

12. Power dissipation: $P_D \leq 0.75\text{ W}$.

Electrical Characteristics (KA78L15A)

$V_I = 23\text{ V}$, $I_O = 40\text{ mA}$, $-40^\circ\text{C} \leq T_J \leq 125^\circ\text{C}$, $C_I = 0.33\text{ }\mu\text{F}$, $C_O = 0.1\text{ }\mu\text{F}$, unless otherwise specified.

Symbol	Parameter	Conditions	Min.	Typ.	Max.	Unit	
V_O	Output Voltage	$T_J = 25^\circ\text{C}$	14.4	15.0	15.6	V	
ΔV_O	Line Regulation ⁽¹³⁾	$T_J = 25^\circ\text{C}$	$17.5\text{ V} \leq V_I \leq 30\text{ V}$		25	300	mV
			$20\text{ V} \leq V_I \leq 30\text{ V}$		20	250	mV
ΔV_O	Load Regulation ⁽¹³⁾	$T_J = 25^\circ\text{C}$	$1\text{ mA} \leq I_O \leq 100\text{ mA}$		25	150	mV
			$1\text{ mA} \leq I_O \leq 40\text{ mA}$		12	75	mV
V_O	Output Voltage	$17.5\text{ V} \leq V_I \leq 30\text{ V}$	$1\text{ mA} \leq I_O \leq 40\text{ mA}$	14.25		15.75	V
		$17.5\text{ V} \leq V_I \leq V_{MAX}^{(14)}$	$1\text{ mA} \leq I_O \leq 70\text{ mA}$	14.25		15.75	V
I_Q	Quiescent Current	$T_J = 25^\circ\text{C}$		2.1	6.0	mA	
ΔI_Q	Quiescent Current Change	With Line	$20\text{ V} \leq V_I \leq 30\text{ V}$			1.5	mA
ΔI_Q		With Load	$1\text{ mA} \leq I_O \leq 40\text{ mA}$			0.1	mA
V_N	Output Noise Voltage	$T_A = 25^\circ\text{C}$, $10\text{ Hz} \leq f \leq 100\text{ kHz}$		90		$\mu\text{V}/V_O$	
$\Delta V_O/\Delta T$	Temperature Coefficient of V_O	$I_O = 5\text{ mA}$		-1.3		$\text{mV}/^\circ\text{C}$	
RR	Ripple Rejection	$f = 120\text{ Hz}$, $18.5\text{ V} \leq V_I \leq 28.5\text{ V}$, $T_J = 25^\circ\text{C}$	34	60		dB	
V_D	Dropout Voltage	$T_J = 25^\circ\text{C}$		1.7		V	

Notes:

13. The maximum steady-state usable output current and input voltage are very dependent on the heat sinking and/or lead length of the package. The data above represents pulse test conditions with junction temperature as indicated at the initiation of tests.

14. Power dissipation: $P_D \leq 0.75\text{ W}$.

Electrical Characteristics (KA78L18A)

$V_I = 27V$, $I_O = 40mA$, $-40^\circ C \leq T_J \leq 125^\circ C$, $C_I = 0.33 \mu F$, $C_O = 0.1 \mu F$, unless otherwise specified.

Symbol	Parameter	Conditions	Min.	Typ.	Max.	Unit	
V_O	Output Voltage	$T_J = 25^\circ C$	17.3	18.0	18.7	V	
ΔV_O	Line Regulation ⁽¹⁵⁾	$T_J = 25^\circ C$	$21 V \leq V_I \leq 33 V$		145	300	mV
			$22 V \leq V_I \leq 33 V$		135	250	mV
ΔV_O	Load Regulation ⁽¹⁵⁾	$T_J = 25^\circ C$	$1 mA \leq I_O \leq 100 mA$		30	170	mV
			$1 mA \leq I_O \leq 40 mA$		15	85	mV
V_O	Output Voltage	$21 V \leq V_I \leq 33 V$	$1 mA \leq I_O \leq 40 mA$	17.1		18.9	V
		$21 V \leq V_I \leq V_{MAX}^{(16)}$	$1 mA \leq I_O \leq 70 mA$	17.1		18.9	V
I_Q	Quiescent Current	$T_J = 25^\circ C$		2.2	6.0	mA	
ΔI_Q	Quiescent Current Change	With Line	$21 V \leq V_I \leq 33 V$		1.5	mA	
ΔI_Q		With Load	$1 mA \leq I_O \leq 40 mA$		0.1	mA	
V_N	Output Noise Voltage	$T_A = 25^\circ C$, $10 Hz \leq f \leq 100 kHz$		150		$\mu V/V_O$	
$\Delta V_O/\Delta T$	Temperature Coefficient of V_O	$I_O = 5 mA$		-1.8		mV/ $^\circ C$	
RR	Ripple Rejection	$f = 120 Hz$, $23 V \leq V_I \leq 33V$, $T_J = 25^\circ C$	34	48		dB	
V_D	Dropout Voltage	$T_J = 25^\circ C$		1.7		V	

Notes:

15. The maximum steady-state usable output current and input voltage are very dependent on the heat sinking and/or lead length of the package. The data above represents pulse test conditions with junction temperature as indicated at the initiation of tests.

16. Power dissipation: $P_D \leq 0.75 W$.

Electrical Characteristics (KA78L05AA)

$V_I = 10\text{ V}$, $I_O = 40\text{ mA}$, $0^\circ\text{C} \leq T_J \leq 125^\circ\text{C}$, $C_I = 0.33\ \mu\text{F}$, $C_O = 0.1\ \mu\text{F}$, unless otherwise specified.

Symbol	Parameter	Conditions	Min.	Typ.	Max.	Unit	
V_O	Output Voltage	$T_J = 25^\circ\text{C}$	4.9	5.0	5.1	V	
ΔV_O	Line Regulation ⁽¹⁷⁾	$T_J = 25^\circ\text{C}$	$7\text{ V} \leq V_I \leq 20\text{ V}$		8	150	mV
			$8\text{ V} \leq V_I \leq 20\text{ V}$		6	100	mV
ΔV_O	Load Regulation ⁽¹⁷⁾	$T_J = 25^\circ\text{C}$	$1\text{ mA} \leq I_O \leq 100\text{ mA}$		11	50	mV
			$1\text{ mA} \leq I_O \leq 40\text{ mA}$		5.0	25	mV
V_O	Output Voltage	$7\text{ V} \leq V_I \leq 20\text{ V}$	$1\text{ mA} \leq I_O \leq 40\text{ mA}$			5.15	V
		$7\text{ V} \leq V_I \leq V_{\text{MAX}}^{(18)}$	$1\text{ mA} \leq I_O \leq 70\text{ mA}$	4.85		5.15	V
I_Q	Quiescent Current	$T_J = 25^\circ\text{C}$		2.0	5.5	mA	
ΔI_Q	Quiescent Current Change	With Line	$8\text{ V} \leq V_I \leq 20\text{ V}$			1.5	mA
ΔI_Q		With Load	$1\text{ mA} \leq I_O \leq 40\text{ mA}$			0.1	mA
V_N	Output Noise Voltage	$T_A = 25^\circ\text{C}$, $10\text{ Hz} \leq f \leq 100\text{ kHz}$		40		$\mu\text{V}/V_O$	
$\Delta V_O/\Delta T$	Temperature Coefficient of V_O	$I_O = 5\text{ mA}$		-0.65		$\text{mV}/^\circ\text{C}$	
RR	Ripple Rejection	$f = 120\text{ Hz}$, $8\text{ V} \leq V_I \leq 18\text{ V}$, $T_J = 25^\circ\text{C}$	41	80		dB	
V_D	Dropout Voltage	$T_J = 25^\circ\text{C}$		1.7		V	

Notes:

17. The maximum steady-state usable output current and input voltage are very dependent on the heat sinking and/or lead length of the package. The data above represents pulse test conditions with junction temperature as indicated at the initiation of tests.

18. Power dissipation: $P_D \leq 0.75\text{ W}$.

Typical Application

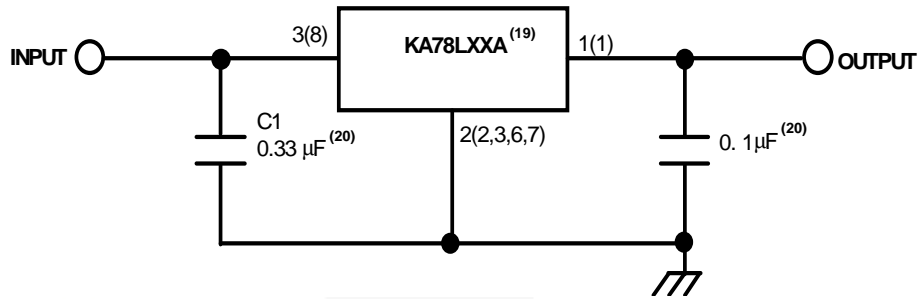
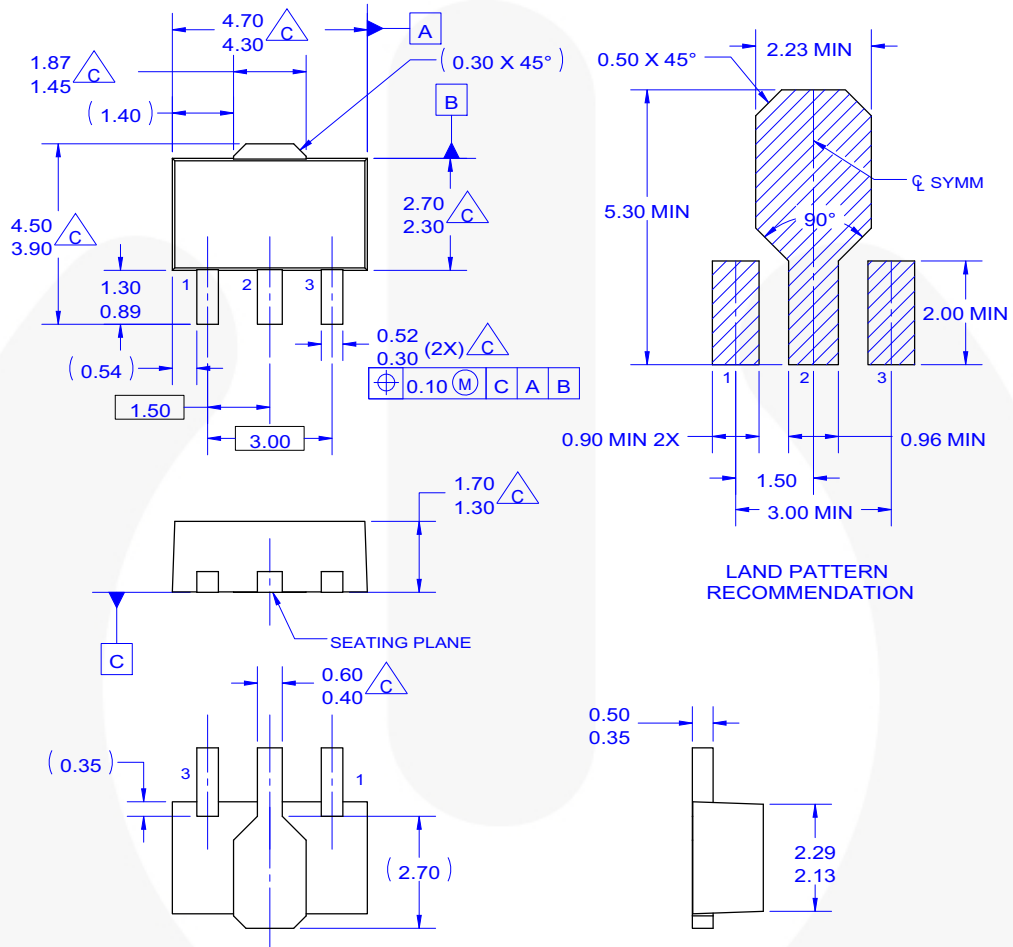

Figure 2. Typical Application

Notes:

- 19. To specify an output voltage, substitute voltage value for "XX".
- 20. Bypass capacitors are recommended for optimum stability and transient response and should be located as close as possible to the regulator.

Physical Dimensions



NOTES: UNLESS OTHERWISE SPECIFIED.

A. REFERENCE TO JEDEC TO-243 VARIATION AA.
 B. ALL DIMENSIONS ARE IN MILLIMETERS.

C. DOES NOT COMPLY JEDEC STANDARD VALUE.
 D. DIMENSIONS ARE EXCLUSIVE OF BURRS,
 MOLD FLASH AND TIE BAR PROTRUSION.
 E. DIMENSION AND TOLERANCE AS PER ASME
 Y14.5-1994.
 F. DRAWING FILE NAME: MA03CREV3

Figure 3. 3-LEAD, SOT-89, JEDEC TO-243, OPTION AA

Physical Dimensions (Continued)

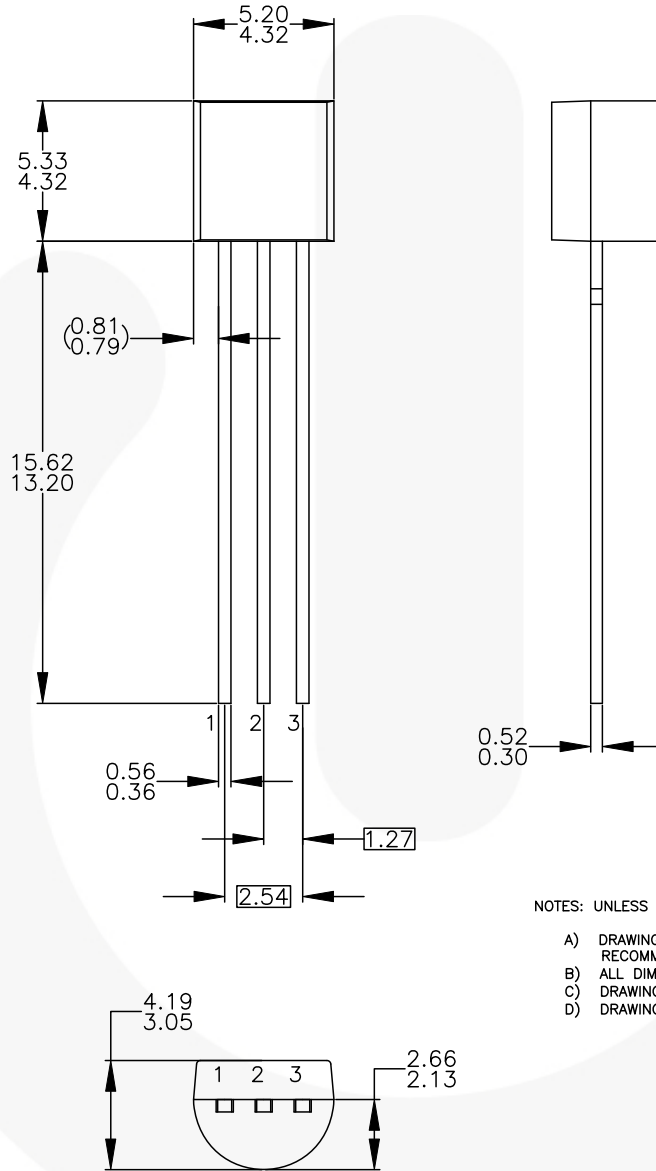
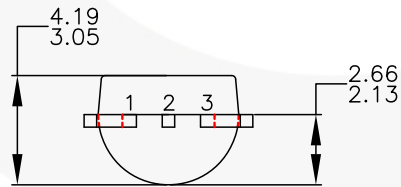
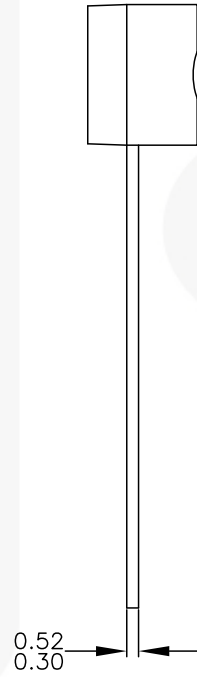
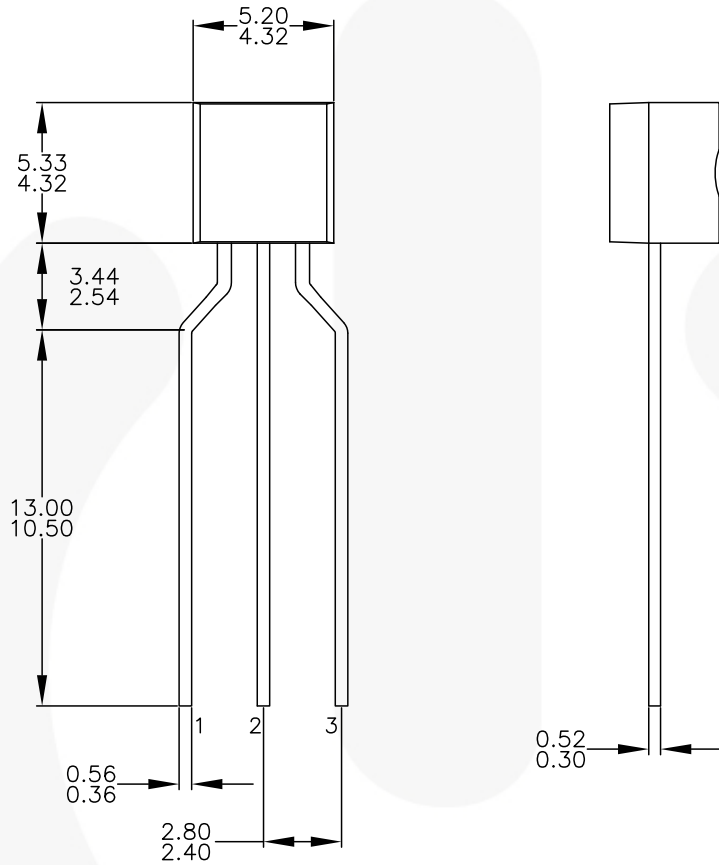

Figure 4. 3-LEAD, TO-92, JEDEC TO-92 COMPLIANT STRAIGHT LEAD CONFIGURATION, BULK TYPE

Physical Dimensions (Continued)



NOTES: UNLESS OTHERWISE SPECIFIED

- A. DRAWING CONFORMS TO JEDEC MS-013, VARIATION AC.
- B. ALL DIMENSIONS ARE IN MILLIMETERS.
- C. DRAWING CONFORMS TO ASME Y14.5M-2009.
- D. DRAWING FILENAME: MKT-ZA03FREV3.
- E. FAIRCHILD SEMICONDUCTOR.

Figure 5. 3-LEAD, TO-92, MOLDED 0.200 IN LINE SPACING LEAD FORM, AMMO TYPE

Physical Dimensions (Continued)

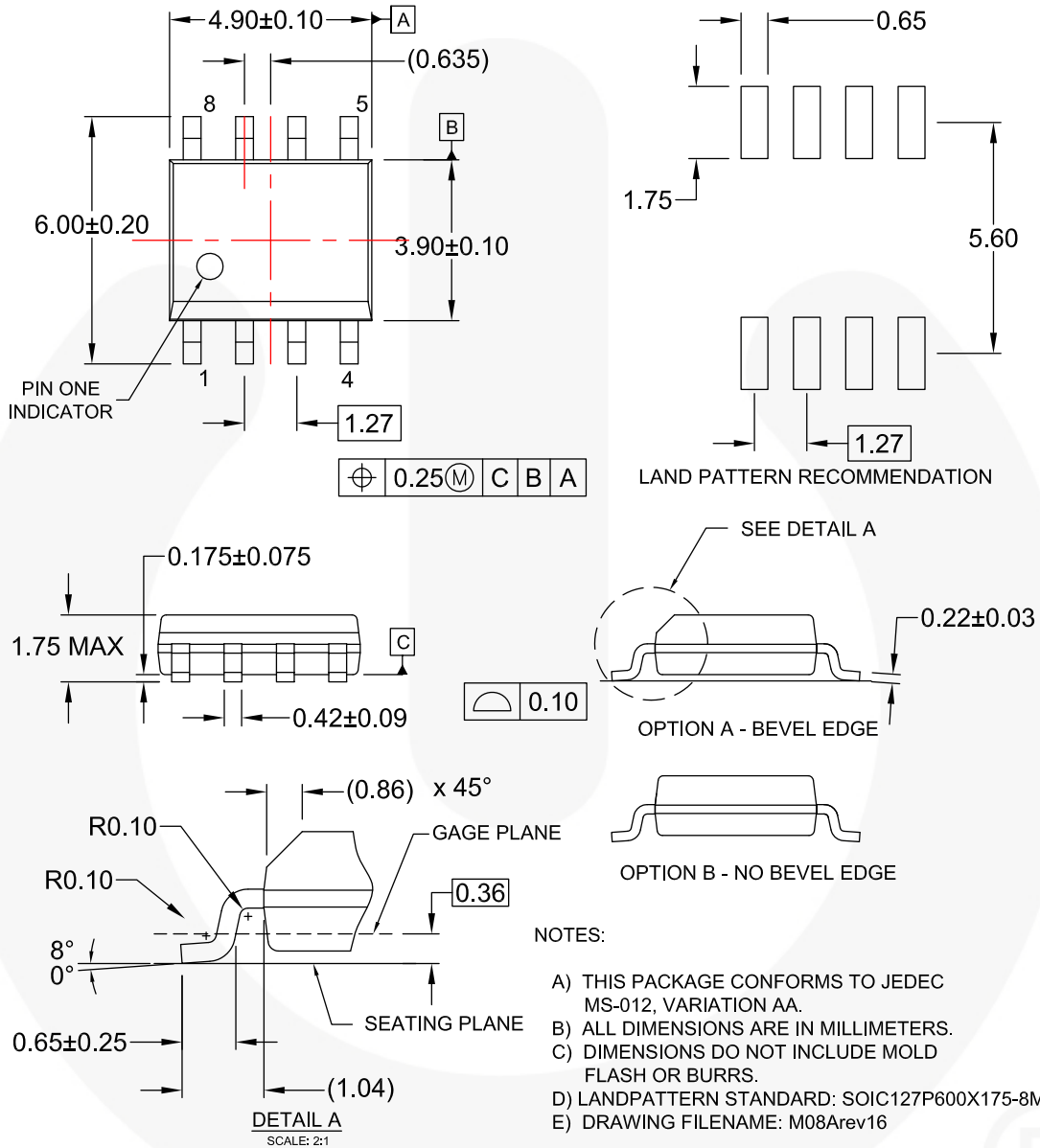







Figure 6. 8-LEAD, SOIC, JEDEC MS-012, 0.150" NARROW BODY





TRADEMARKS

The following includes registered and unregistered trademarks and service marks, owned by Fairchild Semiconductor and/or its global subsidiaries, and is not intended to be an exhaustive list of all such trademarks.

- | | | | |
|--|--|---|---|
| AccuPower™ | F-PFS™ | OPTOPLANAR® |  SYSTEM GENERAL® |
| AttitudeEngine™ | FRFET® |  ® | TinyBoost® |
| Awinda® | Global Power Resource™ | Power Supply WebDesigner™ | TinyBuck® |
| AX-CAP®* | GreenBridge™ | PowerTrench® | TinyCalc™ |
| BitSiC™ | Green FPS™ | PowerXS™ | TinyLogic® |
| Build it Now™ | Green FPS™ e-Series™ | Programmable Active Droop™ | TINYOPTO™ |
| CorePLUS™ | Gmax™ | QFET® | TinyPower™ |
| CorePOWER™ | GTO™ | QS™ | TinyPWM™ |
| CROSSVOLT™ | IntelliMAX™ | Quiet Series™ | TinyWire™ |
| CTL™ | ISOPLANAR™ | RapidConfigure™ | TranSiC™ |
| Current Transfer Logic™ | Making Small Speakers Sound Louder and Better™ |  ™ | TriFault Detect™ |
| DEUXPEED® | MegaBuck™ | Saving our world, 1mW/W/kW at a time™ | TRUECURRENT®* |
| Dual Cool™ | MICROCOUPLER™ | SignalWise™ | μSerDes™ |
| EcoSPARK® | MicroFET™ | SmartMax™ |  SerDes™ |
| EfficientMax™ | MicroPak™ | SMART START™ | UHC® |
| ESBC™ | MicroPak2™ | Solutions for Your Success™ | Ultra FRFET™ |
|  Fairchild® | MillerDrive™ | SPM® | UniFET™ |
| Fairchild Semiconductor® | MotionMax™ | STEALTH™ | VCX™ |
| FACT Quiet Series™ | MotionGrid® | SuperFET® | VisualMax™ |
| FACT® | MTi® | SuperSOT™-3 | VoltagePlus™ |
| FAST® | MTx® | SuperSOT™-6 | XS™ |
| FastvCore™ | MVN® | SuperSOT™-8 | Xsens™ |
| FETBench™ | mWSaver® | SupreMOS® | 仙童™ |
| FPS™ | OptoHiT™ | SyncFET™ | |
| | OPTOLOGIC® | Sync-Lock™ | |

* Trademarks of System General Corporation, used under license by Fairchild Semiconductor.

DISCLAIMER

FAIRCHILD SEMICONDUCTOR RESERVES THE RIGHT TO MAKE CHANGES WITHOUT FURTHER NOTICE TO ANY PRODUCTS HEREIN TO IMPROVE RELIABILITY, FUNCTION, OR DESIGN. TO OBTAIN THE LATEST, MOST UP-TO-DATE DATASHEET AND PRODUCT INFORMATION, VISIT OUR WEBSITE AT [HTTP://WWW.FAIRCHILDSEMI.COM](http://www.fairchildsemi.com). FAIRCHILD DOES NOT ASSUME ANY LIABILITY ARISING OUT OF THE APPLICATION OR USE OF ANY PRODUCT OR CIRCUIT DESCRIBED HEREIN; NEITHER DOES IT CONVEY ANY LICENSE UNDER ITS PATENT RIGHTS, NOR THE RIGHTS OF OTHERS. THESE SPECIFICATIONS DO NOT EXPAND THE TERMS OF FAIRCHILD'S WORLDWIDE TERMS AND CONDITIONS, SPECIFICALLY THE WARRANTY THEREIN, WHICH COVERS THESE PRODUCTS.

AUTHORIZED USE

Unless otherwise specified in this data sheet, this product is a standard commercial product and is not intended for use in applications that require extraordinary levels of quality and reliability. This product may not be used in the following applications, unless specifically approved in writing by a Fairchild officer: (1) automotive or other transportation, (2) military/aerospace, (3) any safety critical application – including life critical medical equipment – where the failure of the Fairchild product reasonably would be expected to result in personal injury, death or property damage. Customer's use of this product is subject to agreement of this Authorized Use policy. In the event of an unauthorized use of Fairchild's product, Fairchild accepts no liability in the event of product failure. In other respects, this product shall be subject to Fairchild's Worldwide Terms and Conditions of Sale, unless a separate agreement has been signed by both Parties.

ANTI-COUNTERFEITING POLICY

Fairchild Semiconductor Corporation's Anti-Counterfeiting Policy. Fairchild's Anti-Counterfeiting Policy is also stated on our external website, www.fairchildsemi.com, under Terms of Use

Counterfeiting of semiconductor parts is a growing problem in the industry. All manufacturers of semiconductor products are experiencing counterfeiting of their parts. Customers who inadvertently purchase counterfeit parts experience many problems such as loss of brand reputation, substandard performance, failed applications, and increased cost of production and manufacturing delays. Fairchild is taking strong measures to protect ourselves and our customers from the proliferation of counterfeit parts. Fairchild strongly encourages customers to purchase Fairchild parts either directly from Fairchild or from Authorized Fairchild Distributors who are listed by country on our web page cited above. Products customers buy either from Fairchild directly or from Authorized Fairchild Distributors are genuine parts, have full traceability, meet Fairchild's quality standards for handling and storage and provide access to Fairchild's full range of up-to-date technical and product information. Fairchild and our Authorized Distributors will stand behind all warranties and will appropriately address any warranty issues that may arise. Fairchild will not provide any warranty coverage or other assistance for parts bought from Unauthorized Sources. Fairchild is committed to combat this global problem and encourage our customers to do their part in stopping this practice by buying direct or from authorized distributors.

PRODUCT STATUS DEFINITIONS

Definition of Terms

Datasheet Identification	Product Status	Definition
Advance Information	Formative / In Design	Datasheet contains the design specifications for product development. Specifications may change in any manner without notice.
Preliminary	First Production	Datasheet contains preliminary data; supplementary data will be published at a later date. Fairchild Semiconductor reserves the right to make changes at any time without notice to improve design.
No Identification Needed	Full Production	Datasheet contains final specifications. Fairchild Semiconductor reserves the right to make changes at any time without notice to improve the design.
Obsolete	Not In Production	Datasheet contains specifications on a product that is discontinued by Fairchild Semiconductor. The datasheet is for reference information only.

Rev. I75

ON Semiconductor and  are trademarks of Semiconductor Components Industries, LLC dba ON Semiconductor or its subsidiaries in the United States and/or other countries. ON Semiconductor owns the rights to a number of patents, trademarks, copyrights, trade secrets, and other intellectual property. A listing of ON Semiconductor's product/patent coverage may be accessed at www.onsemi.com/site/pdf/Patent-Marking.pdf. ON Semiconductor reserves the right to make changes without further notice to any products herein. ON Semiconductor makes no warranty, representation or guarantee regarding the suitability of its products for any particular purpose, nor does ON Semiconductor assume any liability arising out of the application or use of any product or circuit, and specifically disclaims any and all liability, including without limitation special, consequential or incidental damages. Buyer is responsible for its products and applications using ON Semiconductor products, including compliance with all laws, regulations and safety requirements or standards, regardless of any support or applications information provided by ON Semiconductor. "Typical" parameters which may be provided in ON Semiconductor data sheets and/or specifications can and do vary in different applications and actual performance may vary over time. All operating parameters, including "Typicals" must be validated for each customer application by customer's technical experts. ON Semiconductor does not convey any license under its patent rights nor the rights of others. ON Semiconductor products are not designed, intended, or authorized for use as a critical component in life support systems or any FDA Class 3 medical devices or medical devices with a same or similar classification in a foreign jurisdiction or any devices intended for implantation in the human body. Should Buyer purchase or use ON Semiconductor products for any such unintended or unauthorized application, Buyer shall indemnify and hold ON Semiconductor and its officers, employees, subsidiaries, affiliates, and distributors harmless against all claims, costs, damages, and expenses, and reasonable attorney fees arising out of, directly or indirectly, any claim of personal injury or death associated with such unintended or unauthorized use, even if such claim alleges that ON Semiconductor was negligent regarding the design or manufacture of the part. ON Semiconductor is an Equal Opportunity/Affirmative Action Employer. This literature is subject to all applicable copyright laws and is not for resale in any manner.

PUBLICATION ORDERING INFORMATION

LITERATURE FULFILLMENT:

Literature Distribution Center for ON Semiconductor
19521 E. 32nd Pkwy, Aurora, Colorado 80011 USA
Phone: 303-675-2175 or 800-344-3860 Toll Free USA/Canada
Fax: 303-675-2176 or 800-344-3867 Toll Free USA/Canada
Email: orderlit@onsemi.com

N. American Technical Support: 800-282-9855 Toll Free
USA/Canada
Europe, Middle East and Africa Technical Support:
Phone: 421 33 790 2910
Japan Customer Focus Center
Phone: 81-3-5817-1050

ON Semiconductor Website: www.onsemi.com
Order Literature: <http://www.onsemi.com/orderlit>
For additional information, please contact your local
Sales Representative