

DL9118

Multifunction installation tester

Operating Instructions

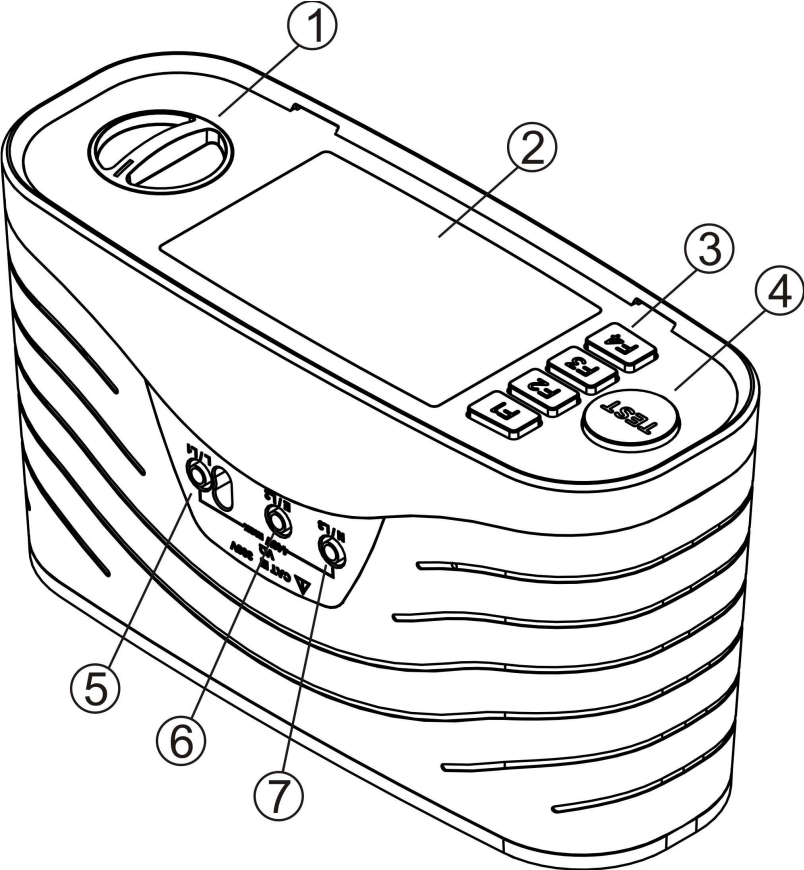

Figure 1 DL9118 Overview

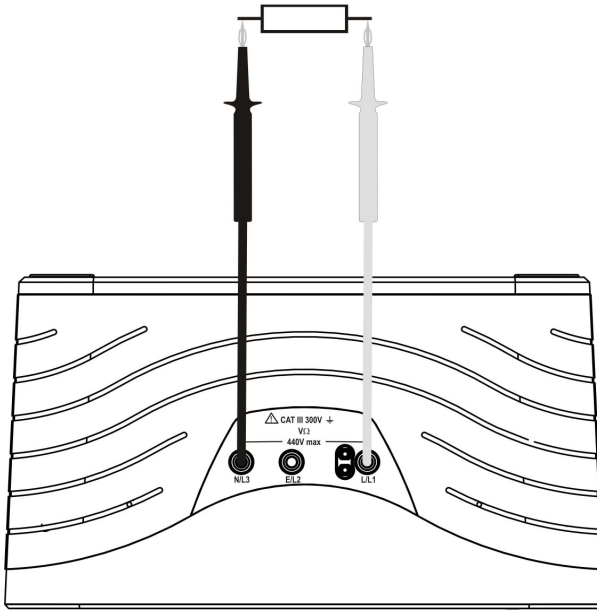

Figure 2 Earth Continuity/Insulation Measurement

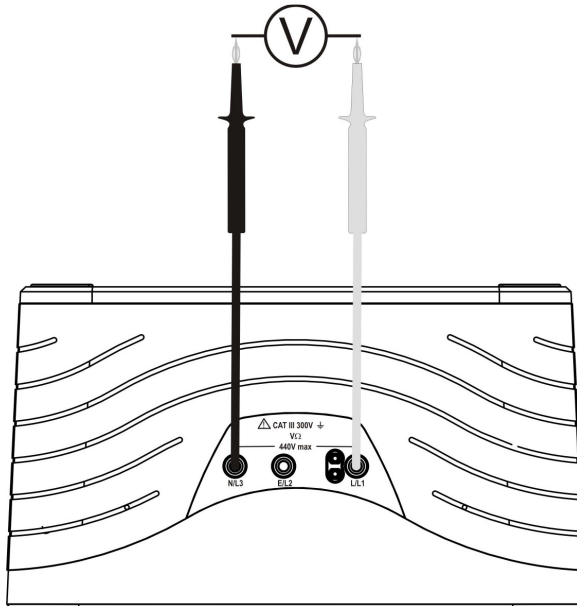

Figure 3 Voltage measurement using test probes

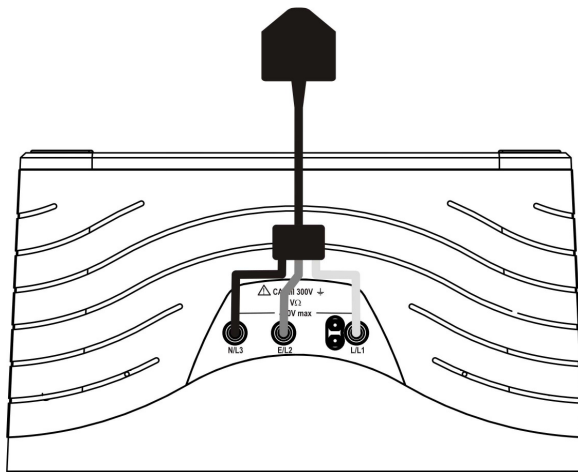

Figure 4 Voltage, RCD, Z_s and line impedance measurement at a mains outlet

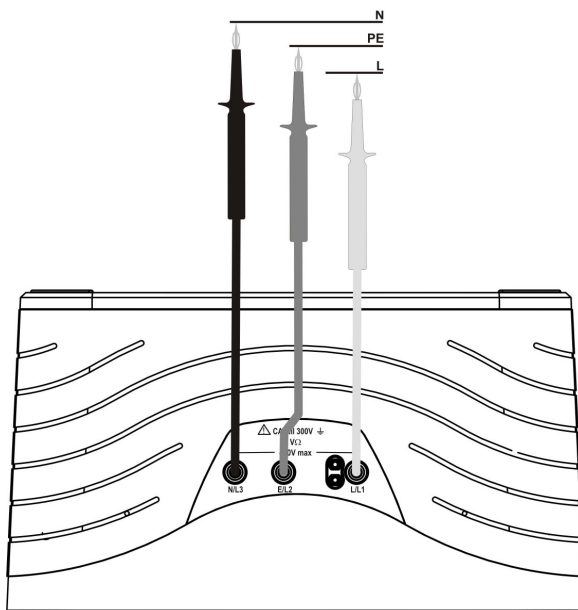

Figure 5 Voltage, RCD, Z_s , Z_e and line impedance measurement at a distribution board

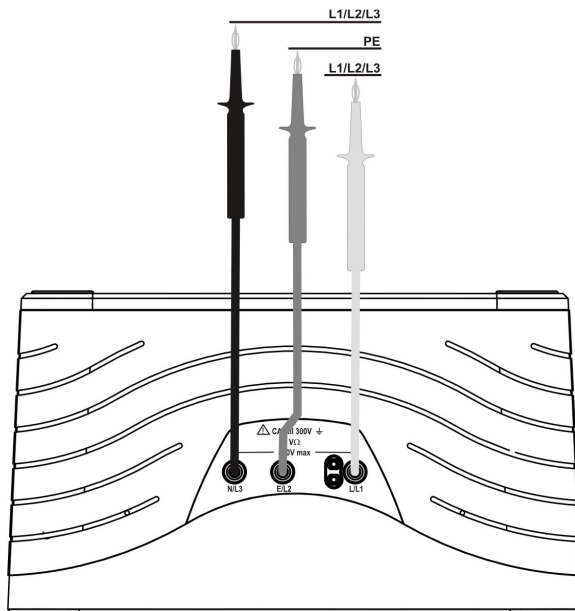

Figure 6 Phase to phase impedance/PSC measurement

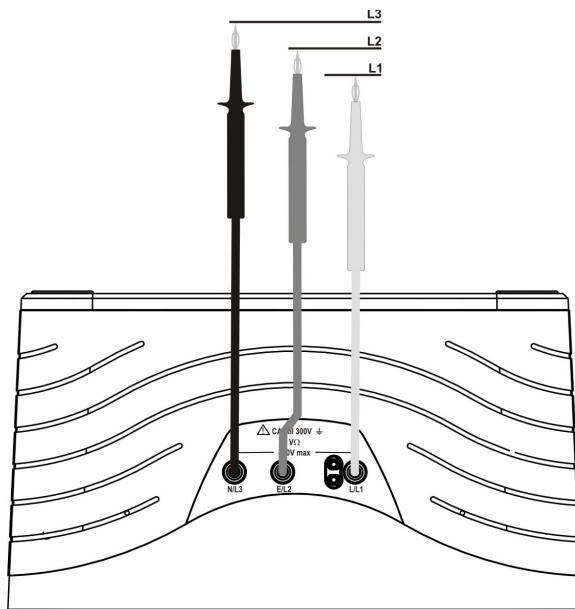

Figure 7 Phase rotation

Limited Warranty & Limitation of Liability

DI-LOG Test Equipment guarantees this product to be free from defects in material and workmanship under normal use and service for a period of 2 year. The period of warranty will be effective at the date of purchase.

(c) Copyright 2016

All rights reserved. Nothing from this edition may be multiplied, or made public in any form or manner, either electronically, mechanically, by photocopying, recording, or in any manner, without prior written consent from DI-LOG. This also applies to accompanying drawings and diagrams.

Due to a policy of continuous development DI-LOG reserves the right to alter the equipment specification and description outlined in this publication without prior notice and no part of this publication shall be deemed to be part of any contract for the equipment unless specifically referred to as an inclusion within such contract.

Table of Contents

Limited Warranty & Limitation of Liability	6
Table of Contents.....	7
Introduction	9
1 User Notes	10
2 Safety Notes.....	11
3 Accessories.....	12
3.1 Standard Accessories.....	12
3.2 Optional Accessories.....	12
4 Unit Description	13
4.1 Identifying parts of the unit.....	13
4.2 LCD display	14
5 Using the DL9118	16
5.1 Power On	16
5.2 Battery Health Check.....	16
5.3 Remote probe	16
5.4 Continuity Tests.....	16
5.5 Insulation Resistance Tests.....	18
5.6 Voltage Measurement.....	19
5.7 High Current Earth Loop Impedance / Line Impedance	19
5.8 Non trip Earth Loop Impedance / Line Impedance	21
5.9 Auto RCD Test Sequence.....	22
5.10 RCD Trip Time Tests	25 ²⁴
5.11 RCD trip current (Ramp) Tests	26
6 Electrical Specifications.....	28
6.1 Earth Continuity	28
6.2 Insulation Resistance.....	28
6.3 Earth Loop Impedance	28
6.4 Line Impedance	28
6.5 RCD	29
6.6 Voltage/Frequency Measurement	29
7 Environmental Conditions.....	30
8 Maintenance.....	31
8.1 Preparing to work on the DL9118.	31
8.2 Securing the DL9118	31
8.3 Cleaning.....	31
8.4 Battery Replacement	32
8.6 Service and Calibration.	33
8.7 Spare Parts.....	34
Appendix A.....	35

Disposal of Old Product

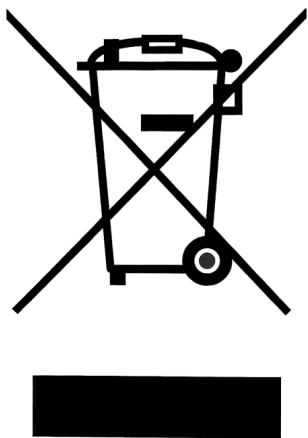

This product has been designed and manufactured with high quality materials and components that can be recycled and reused.

Please familiarise yourself with the appropriate local separate collection system for electrical and electronic products.

Please dispose of this product according to local regulations. Do not dispose of this product along with normal waste material. The correct disposal of this product will help prevent potential negative consequences for the environment and human health.

Introduction

The DL9118 is a hand held, battery powered, multi-function electrical installation test instrument capable of performing a comprehensive range of tests, including:

Earth Continuity @ 200mA
Insulation Resistance at 250V, 500V and 1000V
Voltage
Frequency
Phase rotation
RCD Trip Time at $\frac{1}{2}I_{\Delta n}$, $I_{\Delta n}$ and $5xI_{\Delta n}$
RCD Trip current
Non trip Zs and PFC measurement on RCD protected circuits
High current Ze and PFC on non RCD protected circuits
Phase to neutral impedance and PSC
Phase to phase impedance and PSC
Power socket wiring polarity

1 User Notes

This instrument and its operating instructions are intended for use by adequately trained personnel.

The following symbols are used in these operating instructions and on the DL9118.



Warning of electrical danger!

Indicates instructions must be followed to avoid danger to persons.



Important, follow the documentation! This symbol indicates that the operating instructions must be adhered to in order to avoid danger.

2 Safety Notes

This DL9118 is fully compliant with the requirements of:

BS EN 61010-1: 2010

BS EN 61010-2-30:2010

BS EN 61557 part 1, 2, 3, 4, 6, 7 and 10.

In order to ensure safe operation of this instrument, all notes and warnings in these instructions must be observed at all times.



The DL9118 has been designed to make measurements in a dry environment.



The DL9118 may be used to test circuits with a maximum over-voltage Category III, 300 V AC/DC with reference to earth.



High voltages are present at the probe tips of the DL9118 during insulation resistance measurement. Always hold test probes above the hand guards.



The DL9118 and all associated cables and leads must be checked for signs of damage before equipment is operated.



Prior to any resistance measurement, always ensure that the circuit under test is electrically isolated.

Where safe operation of the DL9118 is no longer possible it should be immediately shut down and secured to prevent accidental operation.

It must be assumed that safe operation is no longer possible:

- if the instrument or leads show visible signs of damage or
- the instrument does not function or
- after long periods of storage under adverse environmental conditions.



If the DL9118 is used in a manner not specified by this document then the protection provided by the equipment may be impaired.

3 Accessories

3.1 Standard Accessories

The DL9118 is supplied with the following items:

- DL9118 unit
- Padded neck strap
- Professional carry case
- DI-LOG mains lead
- 1.2 M black test lead
- 1.2 M red test lead
- 1.2 M green test lead
- Black crocodile clip
- Red crocodile clip
- Green crocodile clip
- Remote probe with test button
- MN1500 (AA) 1.5v Batteries x 6
- Operating Instruction Manual
- Calibration certificate

3.2 Optional Accessories

1.6A 1000V HRC FF Fuse



Do not open unit, no other serviceable parts.

4 Unit Description

The DL9118 is a hand held, multi-function electrical installation test instrument, capable of performing all of the required electrical tests. Tests are selected using the colour coded rotary switch.

4.1 Identifying parts of the unit

The numbering below refers to figure. 1

1. Rotary Switch
 - a. Voltage, Frequency and Phase Rotation
 - b. Insulation resistance @ 1000V
 - c. Insulation resistance @ 500V
 - d. Insulation resistance @ 250V
 - e. Continuity @ 200mA
 - f. Off
 - g. High current Ze/Zs and PSC/PFC
 - h. Non-trip Zs and PFC
 - i. Auto RCD sequence
 - j. RCD trip time @ $\frac{1}{2} I\Delta N$
 - k. RCD trip time @ $I\Delta N$
 - l. RCD trip time @ $5I\Delta N$
 - m. RCD trip time (ramp test)
2. LCD Display
3. Function keys F1, F2, F3 and F4
4. TEST key
5. Test lead input (RED)
6. Test lead input (GREEN)
7. Test lead input (BLACK)

Note: The function performed by keys F1 – F4 depends upon the rotary switch position. For each rotary switch position, the left hand side of the LCD display indicates the function of the key above.

4.2 LCD display

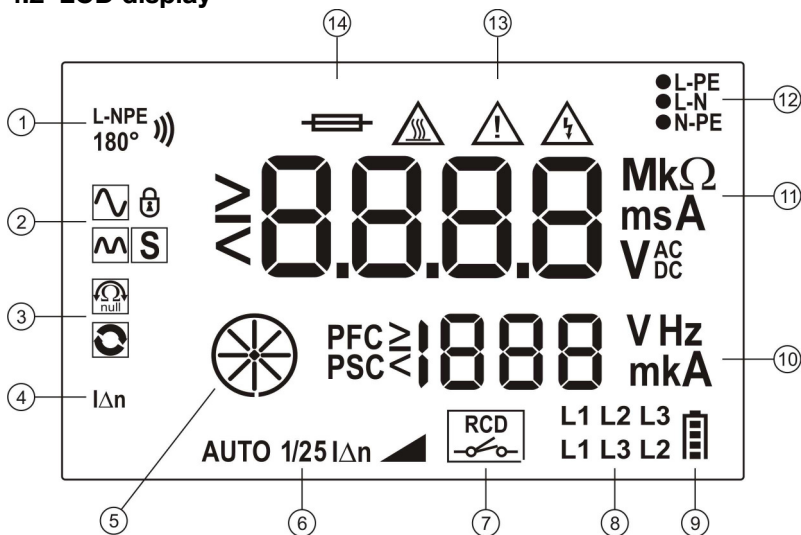

1. Icons for function key F1. These icons are used to display the available options for the selected test. Repeatedly pressing function key F1 cycles through the available options.
2. Icons for function key F2. These icons are used to display the available options for the selected test. Repeatedly pressing function key F2 cycles through the available options.
3. Icons for function key F3. These icons are used to display the available options for the selected test. Repeatedly pressing function key F3 cycles through the available options.
4. Icons for function key F4. These icons are used to display the available options for the selected test. Repeatedly pressing function key F4 cycles through the available options.
5. Zs/Ze progress indicator
6. RCD test icons. These icons display the selected RCD test function.
7. RCD status. Indicates when the RCD has tripped during an RCD test.
8. Phase sequence indicator
9. Battery status indicator. Shows the amount of charge in the batteries.
10. Secondary display.
11. Primary display
12. Mains supply status icons. These icons indicate the status of the mains supply between line and earth (L-PE), line and neutral (L-N) and neutral and earth (N-PE) during RCD and Loop tests.

Note: Testing is inhibited if the mains supply is incorrect.

13. Warning Icons. These icons are used to inform the user of the potential of any hazard or warning which may restrict the operation of the DL9118. Details are provided in the relevant parts of these operating instructions.
14. Fuse warning. Indicates if the internal fuse has blown.

5 Using the DL9118

5.1 Power On

To turn the DL9118 on simply rotate the rotary switch to the required test position.

5.2 Battery Health Check

The DL9118 will automatically perform battery health checks periodically or when a new test type is selected.

Note: When the battery symbol is flashing all tests will be inhibited and the batteries should be replaced as described in section 8.4.

5.3 Remote probe

The remote probe can be used in place of the standard 4mm red test lead. When the remote probe is connected, the TEST button on the probe performs the same function as the TEST key on the DL9118. Either TEST button can be used to initiate a measurement.

5.4 Continuity Tests



Always ensure that the circuit under test is electrically isolated.



Measurements can be adversely affected by impedances of additional operating circuits connected in parallel or by transient currents.



If the test probes are connected across a voltage of >30V ac/dc then the DL9118 will automatically display the voltage between the probes, the warning buzzer will sound and the TEST key is inhibited.

Rotate the rotary switch until the Continuity test is selected.

When the continuity test is selected, the DL9118 will display the user selectable test options for approximately 1 second; Buzzer, Test Lock, Lead Zero and Auto Start. If the Buzzer or Lead Zero was previously enabled then the icon will remain on the display when the continuity test is selected. The Test Lock must be enabled each time the Continuity test is selected.

Functions keys F1-F4 have are used to select the options below:

F1	F2	F3	F4
Buzzer	Test Lock	Lead Zero	Auto start

Buzzer (F1)

When enabled, the Buzzer will sound when the continuity measurement is less than 20 ohms.

Test Lock (F2)

The Test Lock can be used to 'lock' the DL9118 in a continuous measuring mode with a single press. When Test Lock is enabled the LCD shows the padlock icon. When Test Lock is active the TEST key is locked until the feature is disabled by pressing F2 or the rotary switch is moved to another position.

To enable the Test Lock mode, press the F2 key before the TEST key is pressed or press F2 and the TEST simultaneously.

To disable Test Lock, press F2 or turn the rotary switch to another position.

Lead Zero (F3)

The instrument can automatically compensate for the resistance of the test leads as follows:

Fit the supplied crocodile clips to the red and black test probes and connect the test probes firmly together. Press and hold the Lead Zero (F3). The measured resistance of the test leads is shown in the primary display until a beep is heard and the Lead Zero icon is shown on the display. All subsequent measurements will automatically include compensation for the test lead resistance until the function is disabled by pressing function key F3.

Note: A maximum test lead resistance of 10 ohms can nulled out. If the test lead resistance is greater than 10 ohms an error beep will indicate that the Lead Zero function has failed and the display icon will not be shown.

Note: For ease of use, the DL9118 will store the Lead Zero compensation when switched off and recall this value when next switched on. The stored value is only applicable to the test leads used when the compensation measurement was made. If the test leads are replaced the Lead Zero function should be repeated using the replacement test leads.

Auto Start (F4)

When Auto start is activated the AUTO icon is shown on the display. Continuity measurements will start automatically when the test probes are connected to a resistance less than 20kohms.

Note: If the probes are connected to a resistance greater than 20kohms in Auto mode the test will not start.

Note: If the probes are connected to a voltage >30V ac/dc in Auto mode the test will not start. The measured voltage will be shown in the primary display..

The Auto Start function will automatically make measurements when the test leads are connected to a resistance.

When the Auto Start function is disabled press and hold the TEST key to make a continuity measurement. The resistance between the test probes is shown until the TEST key is released. Alternatively, use the Test Lock function to allow measurements to be started or stopped with single press of the TEST key.

During a measurement, the measured value is shown in the primary display and the test voltage is shown in the secondary display.

5.5 Insulation Resistance Tests



Always ensure that the circuit under test is electrically isolated.



If the test probes are connected across a voltage of >30V then the DL9118 will automatically display the voltage between the probes, the warning buzzer will sound and the TEST key is inhibited.

Use the rotary switch to select either the 250V, 500V or 1000V MΩ test. The DL9118 will display the Test Lock and battery symbol for 1 second. If the Test Lock feature is required, it should be activated as described below.

Functions keys F1-F4 have are used to select the options below:

F1	F2	F3	F4
Buzzer	Test Lock	Not used	Not used

Buzzer (F1)

When enabled, the Buzzer will sound when the continuity measurement is less than or equal to 1Mohm.

Test Lock (F2)

The Test Lock is used to 'lock' the DL9118 in a continuous measurement mode, with a single press of the TEST key. When Test Lock is enabled the LCD shows the padlock icon. When Test Lock is active the TEST key is locked until the option is disabled or the rotary switch is moved to another position.

To enable the Test Lock mode, press the F2 key before the TEST key is pressed or press F2 and the TEST simultaneously.

To disable Test Lock, press F2 or turn the rotary switch to another position.

To make an insulation resistance measurement, press and hold the TEST key. The resistance between the test probes is displayed until the TEST key is released. Alternatively, use the Test Lock function to allow measurements to be started or stopped with single press of the TEST key.

During a measurement, the measured value is shown in the primary display and the measured test voltage is shown in the secondary display.

5.6 Voltage Measurement

Rotate the rotary switch until the V test is selected. The DL9118 will automatically measure any voltage present on the test probes. The TEST key is not required.

The function keys do not perform any operations while in Voltage mode.

When an AC voltage is applied to the test probes, the frequency of the measured voltage is shown in the secondary display.

When a 3 phase voltage is connected to the test probes, the voltage between the red and black is displayed in the primary display and the phase sequence icon is shown on the display. When the test probes are connected as follows: RED to L1, GREEN to L2, BLACK to L3 the display icon will show L1 L2 L3.

5.7 High Current Earth Loop Impedance / Line Impedance



The DL9118 will only allow the Earth Loop Impedance test to be performed if the correct voltages are detected between line-earth (L-PE illuminated), line-neutral (L-N illuminated) and neutral-earth (N-PE **not** illuminated).

Rotate the rotary switch until Ze/Zs High is selected. Functions keys F1-F4 have are used to select the options below:

F1	F2	F3	F4
L-PE loop/ L-N loop select	Not used	Not used	Auto Start

Note: When the Ze/Zs High switch position is selected, the DL9118 will default to the last used setting, even if it has been switched off.

L-PE/L-N (F1)

Press the function key F1 to select either the Earth Loop Impedance test (L-PE) or the Line Impedance test (L-N).

Auto Start (F4)

When Auto start is activated the AUTO icon is shown on the display. Loop measurements will automatically start approximately 4s after the DL9118 is connected to correct mains supply via a mains plug or the test probes. The Auto Start function remains enabled if the switch position is changed or the DL9118 is powered off. To disable the Auto Start function press F4.

Note: If the mains supply is removed with the 4s countdown the loop test will not start.

Note: If the mains power is removed during the loop measurement, the test will terminate and the display will show "RCD" to indicate that power has been removed.

To begin the test, press and release the TEST key or select Auto Start using F4.

During the test, progress is shown by the rotating progress icon. When the test is complete, the loop measurement is shown in the primary display and the calculated Prospective Fault Current (PFC) or Prospective Short-circuit Current (PSC) is shown in the secondary display.

Note: The DL9118 will determine the fault voltage that may appear on the protective conductor during the test. If the fault

voltage is greater than 25V the DL9118 will indicate >25V on the LCD, but the user may proceed with the test. If the fault voltage is greater than 50V, this is indicated on the LCD and the test is inhibited.

Note: A Line Impedance measurement is automatically made as part of the Earth Loop Impedance test. The Line Impedance measurement (L-N) and Prospective Short-circuit Current (PSC) can be viewed by simply pressing function key F1, without the need to repeat the test.

5.8 Non trip Earth Loop Impedance / Line Impedance



The DL9118 will only allow the Earth Loop Impedance test to be performed if the correct voltages are detected between line-earth (L-PE illuminated), line-neutral (L-N illuminated) and neutral-earth (N-PE **not** illuminated).

Rotate the rotary switch until Zs Non Trip is selected. Functions keys F1-F4 have are used to select the options below:

F1	F2	F3	F4
L-PE loop/ L-N loop select	Not used	Not used	Auto Start

Note: When the Zs Non Trip switch position is selected, the DL9118 will default to the last used setting, even if it has been switched off.

L-PE/L-N (F1)

Press the function key F1 to select either the Earth Loop Impedance test (L-PE) or the Line Impedance test (L-N).

Auto Start (F4)

When Auto start is activated the AUTO icon is shown on the display. Loop measurements will automatically start approximately 4s after the DL9118 is connected to correct mains supply via a mains plug or the test probes. The Auto Start function remains enabled if the switch position is changed or the DL9118 is powered off. To disable the Auto Start function press F4.

Note: If the mains supply is removed with the 4s countdown the loop test will not start.

Note: If the mains power is removed during the loop measurement, the test will terminate and the display will show “RCD” to indicate that power has been removed.

To begin the test, press and release the TEST key or select Auto Start using F4.

During the test, progress is shown by the rotating progress icon. When the test is complete, the loop measurement is shown in the primary display and the calculated Prospective Fault Current (PFC) or Prospective Short-circuit Current (PSC) is shown in the secondary display.

Note: The DL9118 will determine the fault voltage that may appear on the protective conductor during the test. If the fault voltage is greater than 25V the DL9118 will indicate >25V on the LCD, but the user may proceed with the test. If the fault voltage is greater than 50V, this is indicated on the LCD and the test is inhibited.

Note: A Line Impedance measurement is automatically made as part of the Earth Loop Impedance test. The Line Impedance measurement (L-N) and Prospective Short-circuit Current (PSC) can be viewed by simply pressing function key F1, without the need to repeat the test.

5.9 Auto RCD Test Sequence



The DL9118 will only allow the RCD test to be performed if the correct voltages are detected between line-earth (L-PE illuminated), line-neutral (L-N illuminated) and neutral-earth (N-PE **not** illuminated).



Potential fields from other earthing installations, large voltages between the protective conductor and earth, large voltage between the neutral and earth or leakage currents in the circuit following the residual current protection device may influence the measurement.



Equipment which is connected downstream of a residual current protective device (RCD) may cause a considerable extension of the operating time.

The Auto RCD test is used to automatically perform a sequence of 6 RCD trip time tests with a single press of the TEST key. Each time the

RCD trips, the sequence will automatically continue once the RCD is reset. The sequence comprises of test at:

$\frac{1}{2}I\Delta n / 0^\circ$
 $\frac{1}{2}I\Delta n / 180^\circ$
 $I\Delta n / 0^\circ$
 $I\Delta n / 180^\circ$
 $5I\Delta n / 0^\circ$
 $5I\Delta n / 180^\circ$

Functions keys F1-F4 have are used to select the options below:

F1	F2	F3	F4
Not used	ac/dc/ selective	RCL	Test current

AC/DC/Selective (F2)

Function key F2 is used to select the required RCD type: AC or DC sensitive combined with standard or selective RCD types. Each time the F2 key is pressed the next option is selected

During selective tests the DL9118 will display a delay timer which counts down from 30s to 0s. Pressing the Test key or turning the rotary switch while the DL9118 is counting will terminate the count.



RCL (F3)

The RCL (Recall) key is used to recall the results of the last automatic RCD test performed by the DL9118. The LCD will update to show all of the relevant parameters for the result displayed. Continue to press the F3 key to rotate through the results.

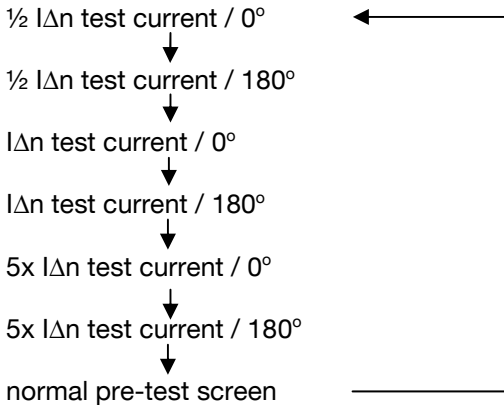

Pressing any key while displaying a recalled measurement will return the DL9118 to the normal pre-test screen.

Rated residual operating current $I_{\Delta n}$ (F4)

The test current can be selected by pressing the F4 key.

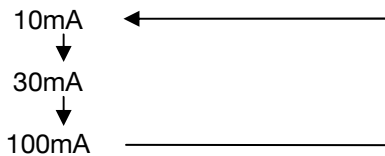

When the required settings have been selected, press the TEST key to begin the sequence.

Note: The DL9118 will determine the fault voltage that may appear on the protective conductor during the test. If the fault voltage is greater than 25V the DL9118 will indicate >25V on the LCD, but the user may proceed with the test. If the fault voltage is great than 50V, this is indicated on the LCD and the test is inhibited.

If the fault voltage is less than 50V the test sequence will proceed and the trip times are shown in the primary display. The fault voltage is measured and not calculated.

When the sequence is completed, the RCL key (F3) is used to recall the measurements.

5.10 RCD Trip Time Tests



The DL9118 will only allow the Earth Loop Impedance test to be performed if the correct voltages are detected between phase-neutral (PN illuminated), phase-earth (PE illuminated) and neutral-earth (NE **not** illuminated).



Leakage currents in the circuit following the residual current protection device may influence the measurement.

Note: The DL9118 will determine the fault voltage that may appear on the protective conductor during the test. If the fault voltage is greater than 25V the DL9118 will indicate >25V on the LCD, but the user may proceed with the test. If the fault voltage is great than 50V, this is indicated on the LCD and the test is inhibited.

Use the rotary switch to select the $\frac{1}{2} I_{\Delta n}$, $I_{\Delta n}$ or $5 I_{\Delta n}$ test position. The $\frac{1}{2} I_{\Delta n}$ test will perform the RCD test with a current of 50% of that indicated on the LCD.

The $I_{\Delta n}$ test will perform the RCD with the test current indicated on the LCD.

The $5 I_{\Delta n}$ test will perform the RCD with 500% that which is indicated on the LCD.

F1	F2	F3	F4
0° / 180°	ac/dc/ selective	Not used	Test current

0° / 180° (F1)

Use the F1 key to alternate between the starting angle of the current. All RCD tests will start on zero crossing.

AC/DC/Selective (F2)

Function key F2 is used to select the required RCD type: AC or DC sensitive combined with standard or selective RCD types. Each time the F2 key is pressed the next option is selected

During selective tests the DL9118 will display a delay timer which counts down from 30s to 0s. Pressing the Test key or turning the rotary switch while the DL9118 is counting will terminate the count.

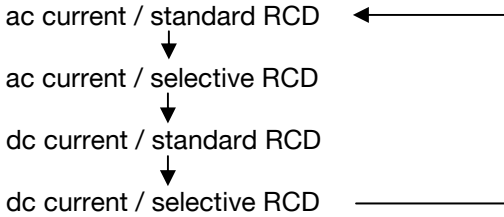

Rated residual operating current $I_{\Delta n}$ (F4)

The test current can be selected by pressing the F4 key.

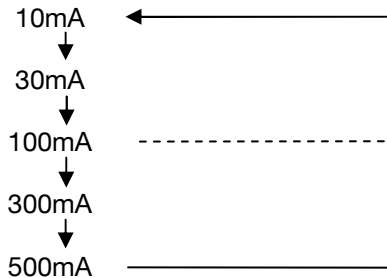

Please note that the DL9118 is not capable of performing all of the different test currents for all of the different manual RCD settings.

	10mA	30mA	100mA	300mA	500mA
$\frac{1}{2} I_{\Delta n}$	✓	✓	✓	✓	✓
$1 I_{\Delta n}$	✓	✓	✓	✓	✓
$5 I_{\Delta n}$	✓	✓	✓		

5.11 RCD trip current (Ramp) Tests



The DL9118 will only allow the Earth Loop Impedance test to be performed if the correct voltages are detected between phase-neutral (PN illuminated), phase-earth (PE illuminated) and neutral-earth (NE **not** illuminated).



Leakage currents in the circuit following the residual current protection device may influence the measurement.

Note: The DL9118 will determine the fault voltage that may appear on the protective conductor during the test. If the fault voltage is greater than 25V the DL9118 will indicate >25V on the LCD, but the user may proceed with the test. If the fault

voltage is great than 50V, this is indicated on the LCD and the test is inhibited.

F1	F2	F3	F4
0° / 180°	AC/DC/Selective	Not used	Test current

0° / 180° (F1)

Use the F1 key to alternate between the starting angle of the current. All RCD tests will start on zero crossing.

AC/DC/Selective (F2)

Function key F2 is used to select the required RCD type: AC or DC sensitive combined with standard or selective RCD types. Each time the F2 key is pressed the next option is selected

During selective tests the DL9118 will display a delay timer which counts down from 30s to 0s. Pressing the Test key or turning the rotary switch while the DL9118 is counting will terminate the count.

Rated residual operating current I_{Δn} (F4)

The test current can be selected by pressing the F4 key.

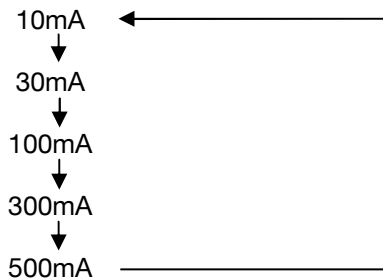

6 Electrical Specifications

6.1 Earth Continuity

Test Voltage Open Circuit	>4V
Test Current into 2□	>200mA
Display Range	0.00Ω - 199Ω
Measuring Range (EN 61557-4)	0.01Ω – 199Ω
Resolution	0.01Ω maximum
Accuracy	±2% ±5 digits
Number of repeat tests as per IEC61557-4	Approx 4000

6.2 Insulation Resistance

Test Voltage	250V/500V/1000V
Test Voltage Specification	-0% +20% (open circuit)
Test Voltage @ 1mA	>1mA into $U_N \times (1000\Omega/V)$
Test Current Short Circuit	<2mA
Display Range	0.01MΩ - 199MΩ
Measuring Range (EN 61557-2)	0.05MΩ – 199MΩ
Resolution	0.01MΩ maximum
Accuracy	±5% ±5 digits
Test Voltage Indication Accuracy	±5%
Number of repeat tests as per IEC61557-2	Approx 3000

6.3 Earth Loop Impedance

Supply Voltage	195 – 253V, 45Hz – 65Hz
Nominal Test Current	<15mA (non-trip test) 3A (high current test)
Display Range	0.01Ω - 2000Ω
Measuring Range (EN 61557-3)	0.10Ω - 1999Ω (high current) 1.00Ω – 1999Ω (non-trip)
Resolution	0.01Ω maximum
Accuracy	±5%±2d (high current) ±5%±12d (non-trip, 1.00Ω - 1.99Ω) ±5%±12d (non-trip, 2.0Ω - 19.9Ω) ±5%±5d (non-trip, 20Ω - 1999Ω)
PFC Range	0 – 26kA

6.4 Line Impedance

Supply Voltage	195V – 253V, 45Hz – 65Hz
----------------	--------------------------

	328V - 440V, 45Hz – 65Hz
Nominal Test Current	3A
Display Range	0.01Ω - 2000Ω
Measuring Range	0.1Ω - 1999Ω
Resolution	0.01Ω maximum
Accuracy	±5% ±2 digits
PFC Range	0kA – 26kA

6.5 RCD

Supply Voltage	195V – 253V, 45Hz – 65Hz
Nominal Test Currents	10mA, 30mA, 100mA, 300mA, 500mA
Test Current Accuracy	-0% +10% at $I_{\Delta n}$ and $5I_{\Delta n}$ -10% +0% at $\frac{1}{2} I_{\Delta n}$
Trip Time Ranges	0ms – 2000ms, $\frac{1}{2} I_{\Delta n}$ 0ms – 300ms, $I_{\Delta n}$ General 0ms – 500ms, $I_{\Delta n}$ Selective 0ms – 40ms, $5I_{\Delta n}$
Trip Time Accuracy	±5% ±2 digits
Ramp Current Range	$\frac{1}{2} I_{\Delta n}$ to $1.1 I_{\Delta n}$
Trip Current Measurement Accuracy	10%

6.6 Voltage/Frequency Measurement

Display Range	0V – 440V
Voltage Measuring Range	0V – 440V
Resolution	1V
Accuracy	±5% ±2 digits
Frequency Range	45Hz – 65Hz
Frequency Accuracy	±1Hz

7 Environmental Conditions

The DL9118 has been designed to perform tests and measurements in a dry environment.

Maximum barometric elevation for making measurements is 2000M.

Overvoltage category IEC 60664/IEC 61010, 300V Category III.

Pollution degree 2 according to IEC 61010-1.

Protective system IP40 according to IEC 60529.

Electromagnetic compatibility (EMC). Interference immunity and emitted interference conforming to IEC 61326-1.

Operating temperature range of 0°C to 40°C, without moisture condensation.

The DL9118 can be stored at any temperature in the range -25°C to +65°C (relative humidity up to 90%). The batteries should be taken out of the instrument for storage.

Operating Altitude 0 to 2000 metres

8 Maintenance



Before opening the DL9118 ensure that it is disconnected from all voltage! Electric shock danger!

8.1 Preparing to work on the DL9118.

Make the DL9118 is voltage free as follows, before opening the instrument;

Power the unit off using the rotary switch by selecting the Off position on the rotary switch.

Disconnect all of the test leads from the unit

8.2 Securing the DL9118

Under certain conditions safe operation of the DL9118 can no longer be assumed:

Visible damage of the instrument case.

Incorrect measurement results.

Recognisable abuse to the instrument due to prolonged storage under improper conditions.

Recognisable abuse to the instrument due to extraordinary transportation stress.

Check the battery compartment for signs of battery electrolyte leakage.

In these cases, the DL9118 should be immediately switched off, disconnected from any test or measurement function and secured to prevent any further use.

8.3 Cleaning

Clean the external case of the DL9118 with a clean dry cloth.

Avoid using solvents and abrasive scouring agents to clean the external case of the DL9118.

Check the battery contacts and compartment are free of electrolytic contamination.

Any contamination of the battery contacts or compartment should be cleaned with a dry cloth.

8.4 Battery Replacement



Before opening the DL9118 ensure that it is disconnected from all voltage! Electric shock danger!

Power the unit off by selecting the Off position on the rotary switch.

Disconnect all the test leads from the unit

Position the DL9118 face down and release the 4 captive screws in the battery compartment cover.

Remove the battery compartment cover.

Remove the discharged batteries from the compartment.

Fit a new set of MN1500 (AA) 1.5v batteries.

Relocate the battery cover over the battery compartment and fasten in position with the battery cover captive screws.

8.5 Replacing the Fuse.



Before opening the DL9118 ensure that it is disconnected from all voltages! Electric shock danger!



All replacement fuse types are specified for ratings and size on the battery compartment cover on the DL9118.

Power the unit off by selecting the Off position on the rotary switch.

Disconnect all the test leads from the unit.

Position the DL9118 face down and release the captive 4 screws in the battery compartment cover.

Remove the battery compartment cover.

Lift one end of the fuse out of the fuse holder with the help of a flat bladed screwdriver.

Lift the defective fuse completely out of the fuse holder.

Insert a new fuse as described and specified by the text on the battery compartment cover.

Ensure that the new fuse is seated and centred in the fuse holder.

Relocate the battery cover over the battery compartment and fasten in position with the battery cover captive screws.

8.6 Service and Calibration.

To maintain the specified accuracy of the measurement results, the instrument must be recalibrated at regular intervals by either the manufacturer or an authorised Service Agent. We recommend a recalibration period of one year.

8.7 Spare Parts.

	Part No.
3 wire lead set c/w croc clips	LS3W9073
Mains lead	ML9073
Remote Probe	RP9118
Carrying Case	CC9118
1.6A 1000V HRC FF Fuse	

For help or advice on Service and Calibration contact:

Service Department
Di-Log Test Equipment
28 Wheel Forge Way
Trafford Park
Manchester
M17 1EH

Tel: 0161 877 0322
Fax: 0161 877 1614
email: support@dilog.co.uk
web: dilog.co.uk

Appendix A

IEC61557-2: Insulation		
Intrinsic error or influence quantity	Reference conditions or specified operating range	Designation code
Intrinsic error	Reference conditions	A
Position	Reference position $\pm 90^\circ$	E ₁
Supply voltage	At the limits stated by the manufacturer	E ₂
Temperature	0°C and 40°C	E ₃
Operating Error	$B = \pm(A + 1.15\sqrt{E_1^2 + E_2^2 + E_3^2})$	

IEC61557-3: Loop Impedance		
Intrinsic error or influence quantity	Reference conditions or specified operating range	Designation code
Intrinsic error	Reference conditions	A
Position	Reference position $\pm 90^\circ$	E ₁
Supply voltage	At the limits stated by the manufacturer	E ₂
Temperature	0°C and 40°C	E ₃
Phase Angle	At a phase angle 0° to 18°	E ₆
System Phase Angle	At a system phase angle 0° to 18° at the bottom of the measuring range.	E _{6.1}
System Phase Angle	At a system phase angle 0° to 30° at the bottom of the measuring range.	E _{6.2}
System frequency	99% to 101% of the nominal frequency	E ₇
System voltage	85% to 110% of the nominal voltage	E ₈
Harmonics	5% of 3 rd harmonic at 0° phase angle. 6% of 5 th harmonic at 180° phase angle. 5% of 7 th harmonic at 0° phase angle.	E ₉
DC Quantities	Add additional dc quantities of 0.5% of nominal voltage of the distribution system in both polarities.	E ₁₀
Operating Error	$B = \pm(A + 1.15\sqrt{E_1^2 + E_2^2 + E_3^2 + E_6^2 + E_7^2 + E_8^2 + E_9^2 + E_{10}^2})$	

IEC61557-4: Resistance of earth connection and equipotential bonding		
Intrinsic error or influence quantity	Reference conditions or specified operating range	Designation code
Intrinsic error	Reference conditions	A
Position	Reference position $\pm 90^\circ$	E ₁
Supply voltage	At the limits stated by the manufacturer	E ₂
Temperature	0C and 40C	E ₃
Operating Error	$B = \pm(A + 1.15\sqrt{E_1^2 + E_2^2 + E_3^2})$	

IEC61557-6: Residual current devices (RCD) in TT and TN systems		
Intrinsic error or influence quantity	Reference conditions or specified operating range	Designation code
Intrinsic error	Reference conditions	A
Position	Reference position $\pm 90^\circ$	E_1
Supply voltage	At the limits stated by the manufacturer	E_2
Temperature	0°C and 40°C	E_3
Resistance of the probes	Within the limits stated by the manufacturer	E_5
System voltage	85% to 110% of the nominal voltage	E_8
Operating Error	$B = \pm (A + 1.15 \sqrt{E_1^2 + E_2^2 + E_3^2 + E_5^2 + E_8^2})$	