

General Description

The MAX40007 evaluation kit (EV kit) is a fully assembled and tested circuit board that contains all the components necessary to evaluate the MAX40007 IC, offered in a space-saving 1.1mm x 0.76mm, 6-bump wafer-level package (WLP). The device is a rail-to-rail micropower op amp drawing only 700nA of supply current. The EV kit operates from a single 1.7V to 5.5V DC power supply.

Features

- 1.7V to 5.5V Single-Supply Operation
- Comes in Unity-Gain Buffer Configuration
- Can Be Configured in Inverting, Non-Inverting, and Differential Amplifier Configurations
- Evaluates the Device in a 6-Bump WLP
- Proven PCB Layout
- Fully Assembled and Tested

Quick Start

Required Equipment

- MAX40007 EV kit
- 1.7V to 5.5V, 100mA DC power supply
- Voltmeter

[Ordering Information](#) appears at end of data sheet.

Procedure

The EV kit is fully assembled and tested. Follow the steps below to verify board operation. **Caution: Do not turn on power supplies until all connections are completed and turn on V_{CC}, V_{SS} supplies before turning on power supplies on the input pins.**

- 1) Make sure J1 jumper is uninstalled and J2 jumper is in 2-3 position for single-supply operation. J2 should be in 1-2 position for split-supply operation.
- 2) **Single-supply operation:** Connect the positive terminal of the +5V supply to the VDD test point and the GND terminal of supply to the GND test point. Make sure J2 is in 2-3 position. The power supply should be off.
- 3) Connect the positive terminal of the precision voltage source to the IN+ test point.
- 4) Connect the DMM to monitor the voltage on the OUT test point.
- 5) Turn on the 5V power supply and apply 2.5V from the precision voltage source. Observe the output at the OUT test point on the DMM. OUT should read approximately 2.5V. Also, vary IN+ voltage between 0.05V to 3.9V to see if DMM on the OUT test point follows the IN+ voltage applied.
- 6) **Split-supply operation:** Connect the positive terminal of the +2.5V supply to the VDD test point and the GND terminal of the supply to the GND test point. Connect -2.5V supply to VSS test point. Make sure J2 is in 1-2 position for this test.
- 7) Connect the positive terminal of the precision voltage source to the IN+ test point.
- 8) Connect the DMM to monitor the voltage on the OUT test point.
- 9) Turn on the +2.5V and -2.5V power supply and apply 1V from the precision voltage source. Observe the output at the OUT test point on the DMM. OUT should read approximately 1V. Also, vary IN+ voltage between -2.45V to 1.4V to see if DMM on the OUT test point follows the applied IN+ voltage.

Detailed Description of Hardware

The MAX40007 EV kit contains the MAX40007 IC, which is a rail-to-rail output micropower op amp with an ultra-low 700nA supply current designed in a 6-bump WLP. The EV kit operates from a single 1.7V to 5.5V DC power supply.

Default Application Circuit

The EV kit comes preconfigured in a unity-gain buffer configuration.

Op Amp Configurations

The EV kit provides flexibility to easily reconfigure the op amp into any of the three common circuit topologies: inverting amplifier, noninverting amplifier, differential amplifier. These configurations are described in the next few sections.

Noninverting Amplifier

To configure the device as a noninverting amplifier, replace R4 and R3 with suitable resistors. Install J1 to configure the op amp into noninverting mode. The output voltage (V_{OUT}) for the noninverting configuration is given by the following equation:

$$V_{OUT} = \left(1 + \frac{R4}{R3}\right) (V_{IN+} + V_{OS})$$

where:

V_{OS} = Input-referred offset voltage.

V_{IN+} = Input voltage applied at the IN+ PCB pad.

Inverting Amplifier

To configure the device as an inverting amplifier, replace R4 and R3 with suitable gain resistors. An appropriate DC voltage (V_{DC}) should be applied to the IN+ test point to level-shift the output voltage of the op amp if the applied input voltage (V_{IN-}) at the IN- test point pad is positive:

$$V_{OUT} = -\frac{R4}{R3} (V_{IN-}) + \left(1 + \frac{R4}{R3}\right) (V_{OS}) + (V_{DC})$$

Differential Amplifier

To configure the device as a differential amplifier, replace R2, R_{CI}, R3, and R4 with appropriate resistors. When R_{CI} = R4 and R2 = R3, the CMRR of the differential amplifier is determined by the matching of ratios R3/R4 and R2/R_{CI}:

$$V_{OUT} = GAIN (V_{IN+} - V_{IN-}) + \left(1 + \frac{R4}{R3}\right) V_{OS}$$

where:

$$GAIN = \frac{R_{CI}}{R2} = \frac{R4}{R3}$$

***Note:** R_{CI} means resistor on CI Pad.

Buffer Amplifier

By default, the EV kit is configured as a standard unity-gain buffer.

$$V_{OUT} = V_{IN+} + V_{OS}$$

Table 1. Default Jumper Settings

JUMPER	SHUNT POSITION	DESCRIPTION
JU1	Not installed	IN- to GND
JU2	2-3	V _{SS} = GND
	1-2	User-defined V _{SS} on VSS test point

Component Suppliers

SUPPLIER	WEBSITE
Murata Electronics North America, Inc.	www.murata.com

Note: Indicate that you are using the MAX40007 when contacting this component supplier.

Ordering Information

PART	TYPE
MAX40007EVKIT#	EV Kit

#RoHS-compliant

MAX40007 Evaluation Kit

Evaluates: MAX40007

MAX40007 EV Kit Bill of Materials

ITEM	QTY	REF DES	VAR STATUS	MAXIM	MFG PART #	MANUFACTURER	VALUE	DESCRIPTION	COMMENTS
1	2	C3, C5	Pref	20-00001-8463	CC118R7H104K1Z; CC332X7R104K080AE	MURATA,TDK	0.1UF	CAPACITOR,SMT (0603), CERAMIC,CHIP,0.1UF,50V; TOL = 10%; TG = -55C TO +125C; TC = X7R; AUTO	
2	3	GND_GND_1, GND_2	Pref	02-1PMMN6011-00	5011	KEYSTONE	N/A	TEST POINT PIN DIA = 0.15MM, TOTAL LENGTH = 0.44MM, BOARD HOLE = 0.063IN; BLACK PHOSPHOR BRONZE WIRE SILVER PLATE FINISH RECOMMENDED FOR BOARD THICKNESS = 0.062IN; NOT FOR COLD TEST	
3	3	IN+, IN-, VOUT	Pref	02-1PMMN6012-00	5012	KEYSTONE	N/A	TEST POINT PIN DIA = 0.15MM, TOTAL LENGTH = 0.44MM, BOARD HOLE = 0.063IN; WHITE PHOSPHOR BRONZE WIRE SILVER PLATE FINISH RECOMMENDED FOR BOARD THICKNESS = 0.062IN; NOT FOR COLD TEST	
4	1	J1	Pref	01-FEC02SAANPZ-21	FEC02SAAN	SULLINS	FEC02SAAN	CONNECTOR,MALE, THROUGH HOLE,BREAKAWAY, STRAIGHT, 2PINS	
5	1	J2	Pref	01-FEC03SAANPZ-21	FEC03SAAN	SULLINS	FEC03SAAN	CONNECTOR,MALE, THROUGH HOLE,BREAKAWAY, STRAIGHT, 3PINS	
6	4	R1, R2, R4, R5	Pref	86-0000R-27	CR0W060300002S; MCR03EZP-000; ENJ-38E10K00	VIKING ELECTRONICS/ PANASONIC	0	RESISTOR, 0603, 001, 0%, JUMPER, 0.10W, THICK FILM	
7	2	SU1, SU2	Pref	02-JMPFST02SVAN-00	ST02SVAN	SULLINS ELECTRONICS CORP.	ST02SVAN	TEST POINT, JUMPER, STR, TOTAL LENGTH = 0.256IN, BLACK; INSULATION = PBT CONTACT = PHOSPHOR BRONZE, COPPER PLATED TIN OVERBALL	
8	1	U1	Pref	MAX40007	MAX40007	MAXIM	MAX40007	EVKIT PART IC: MAX40007SVATP, QZ26; INSULATION = PBT CONTACT = PHOSPHOR BRONZE, COPPER PLATED TIN OVERBALL	
9	1	VDD	Pref	02-1PMMN6012-00	5010	KEYSTONE	N/A	TEST POINT PIN DIA = 0.15MM, TOTAL LENGTH = 0.44MM, BOARD HOLE = 0.063IN; TEST POINT WITH 1.8MM HOLE DIA, RED, MULTIBROUSE, NOT FOR COLD TEST	
10	1	VSS	Pref	02-1PMMN6014-00	5013	KEYSTONE	N/A	TEST POINT PIN DIA = 0.15MM, TOTAL LENGTH = 0.44MM, BOARD HOLE = 0.063IN; ORANGE PHOSPHOR BRONZE WIRE SILVER PLATE FINISH RECOMMENDED FOR BOARD THICKNESS = 0.062IN; NOT FOR COLD TEST	
11	1		Pref	EPG3B40007	MAX40007	MAXIM	PCB	PCB: MAX40007	
TOTAL	20								
DO NOT PURCHASE (DNP)									
ITEM	QTY	REF DES	VAR STATUS	MAXIM	MFG PART #	MANUFACTURER	VALUE	DESCRIPTION	COMMENTS
1	4	C1, C2, C4, C6	DNP	N/A	N/A	N/A		PACKAGE OUTLINE:0603 NON-POLAR CAPACITOR - EVKIT	
2	2	R3, R6	DNP	N/A	N/A	N/A	OPEN	PACKAGE OUTLINE:0603 RESISTOR - EVKIT	
TOTAL	6								
PACKOUT (These are purchased parts but not assembled on PCB and will be shipped with PCB)									
ITEM	QTY	REF DES	MAXIM	MFG PART #	MANUFACTURER	VALUE	DESCRIPTION	COMMENTS	
1	1	PACKOUT	86-00711-SML	86-00711-SML	N/A	?	BOX SMALL BROWN 9.3"X8.7X1.1/4" - PACKOUT		
2	1	PACKOUT	87-02162-00	87-02162-00	N/A	?	ESD BAG,BAG,STATIC SHIELD ZIP-40X80R; WESD LOGO - PACKOUT		
3	1	PACKOUT	85-MAXKIT-FPK	85-MAXKIT-FPK	N/A	?	PINK FOAM/FOAM; WITH STATIC PROTECTIVE BAG; FOR MAXIM DATA SHEET		
4	1	PACKOUT	EVNSERT	EVNSERT	N/A	?	EVNSERT FOR EVKIT		
5	1	PACKOUT	86-54003-506	86-54003-506	N/A	?	LABEL(VITRION) - PACKOUT		
TOTAL	5								

MAX40007 EV Kit Schematic

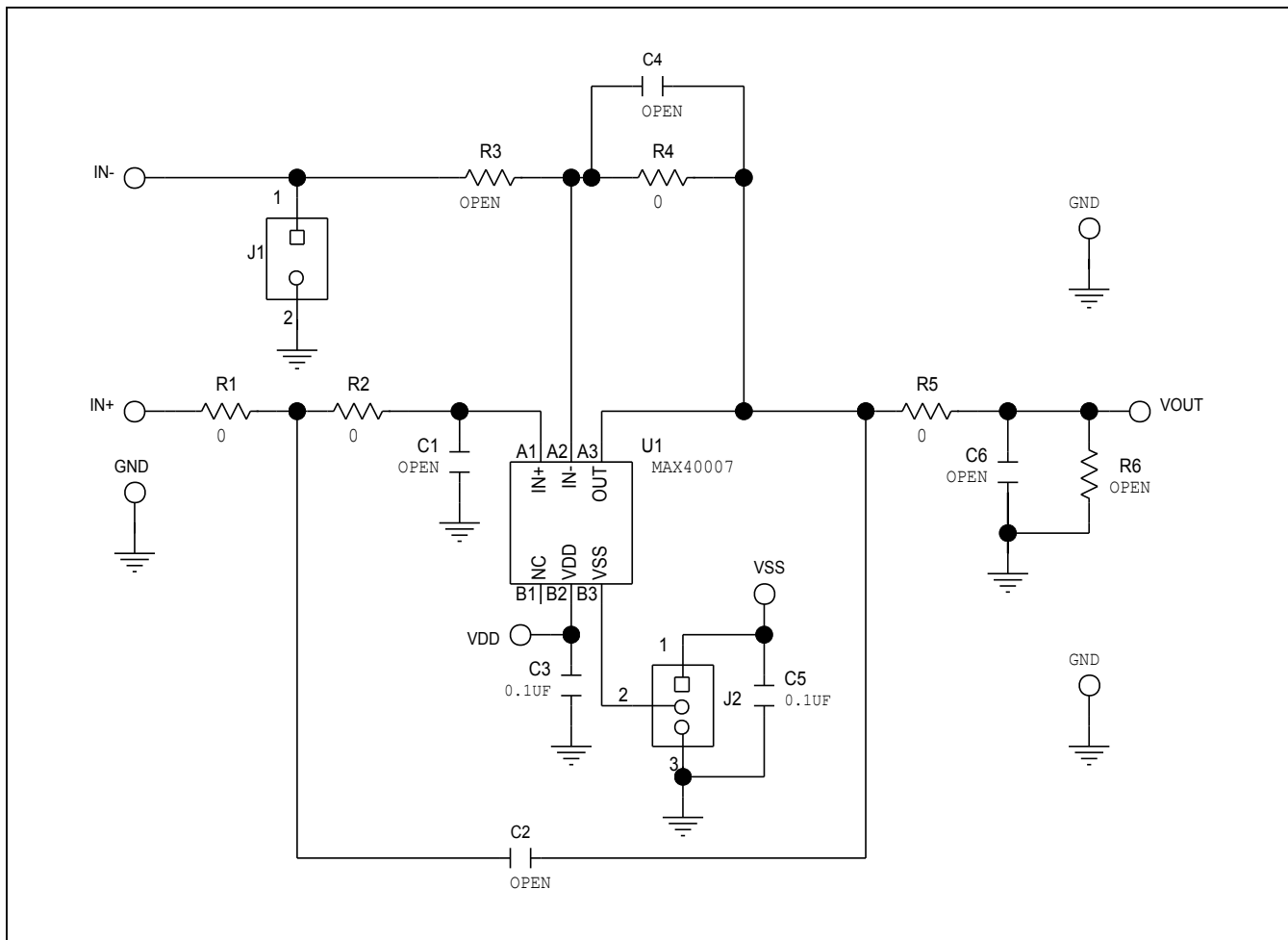

MAX40007 EV Kit PCB Layout Diagrams

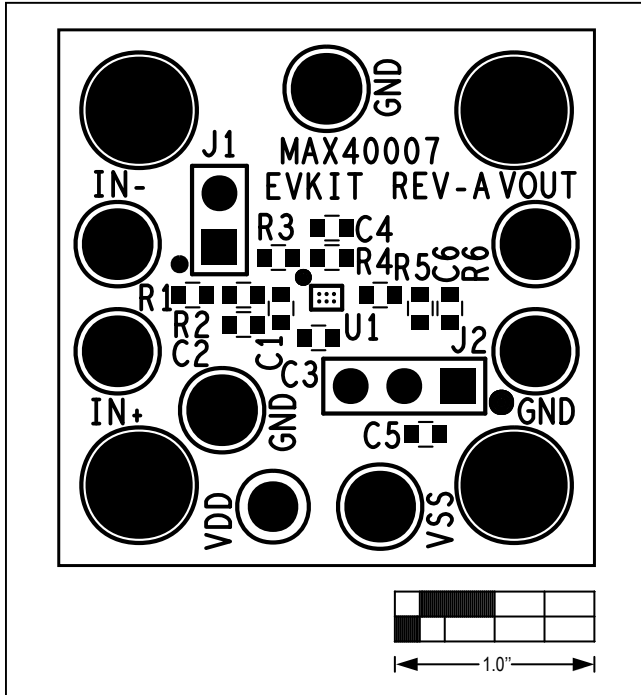

MAX40007 EV Kit—Top Silkscreen

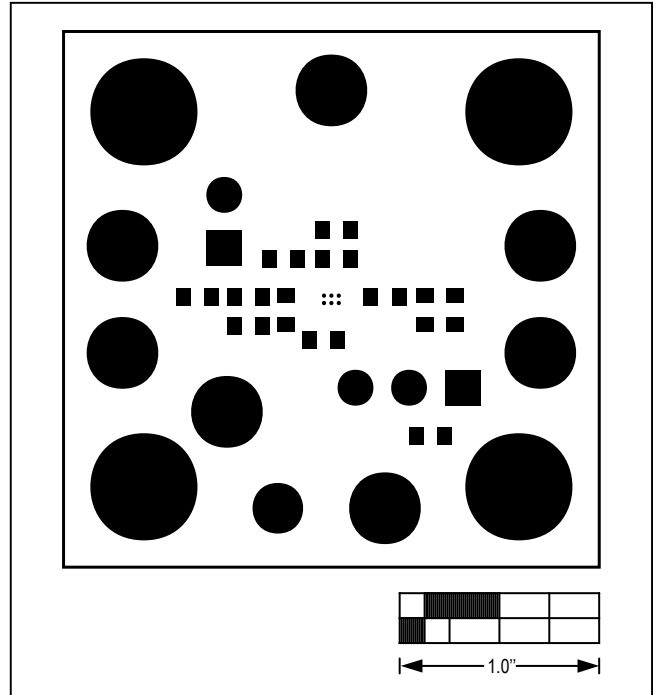

MAX40007 EV Kit—Top Mask

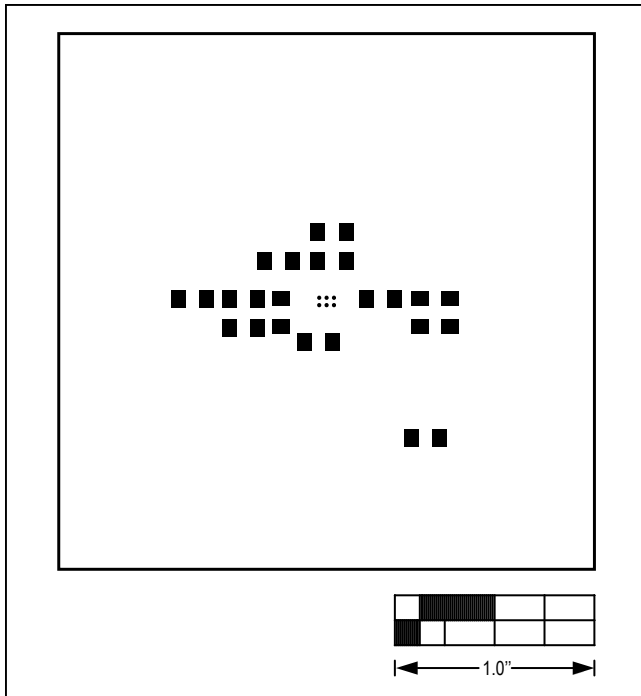

MAX40007 EV Kit—Top Paste

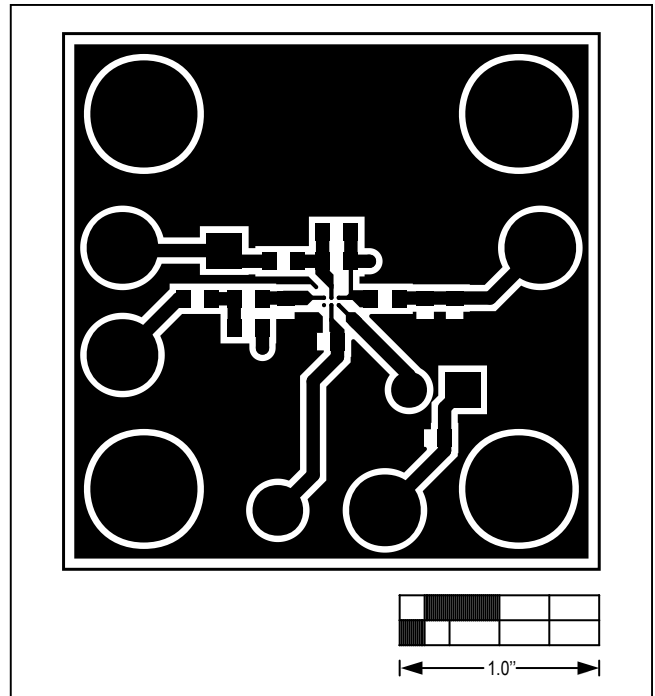

MAX40007 EV Kit—Top

MAX40007 EV Kit PCB Layout Diagrams (continued)

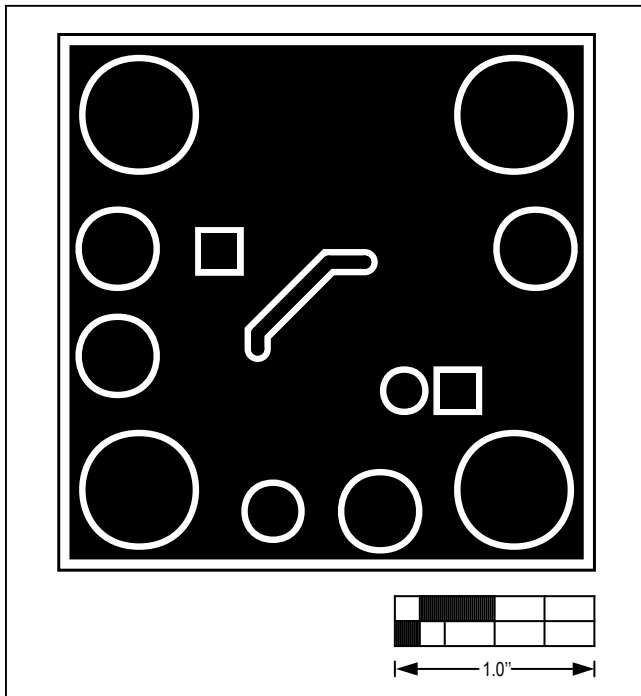

MAX40007 EV Kit—Bottom

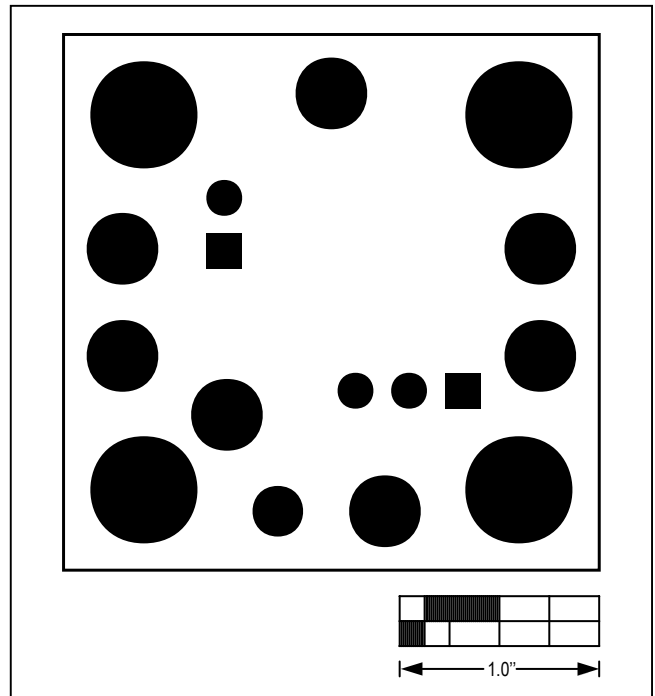

MAX40007 EV Kit—Bottom Mask

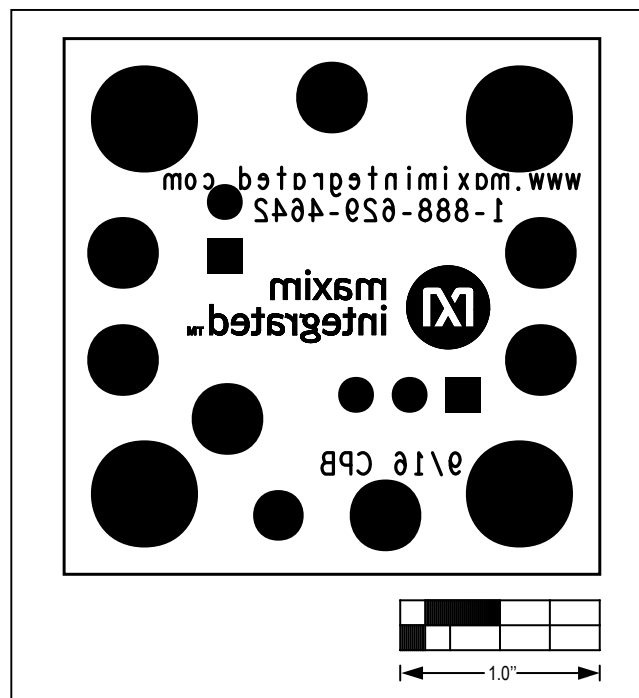

MAX40007 EV Kit—Bottom Silkscreen

Revision History

REVISION NUMBER	REVISION DATE	DESCRIPTION	PAGES CHANGED
0	1/17	Initial release	—

For pricing, delivery, and ordering information, please contact Maxim Direct at 1-888-629-4642, or visit Maxim Integrated's website at www.maximintegrated.com.

Maxim Integrated cannot assume responsibility for use of any circuitry other than circuitry entirely embodied in a Maxim Integrated product. No circuit patent licenses are implied. Maxim Integrated reserves the right to change the circuitry and specifications without notice at any time.