

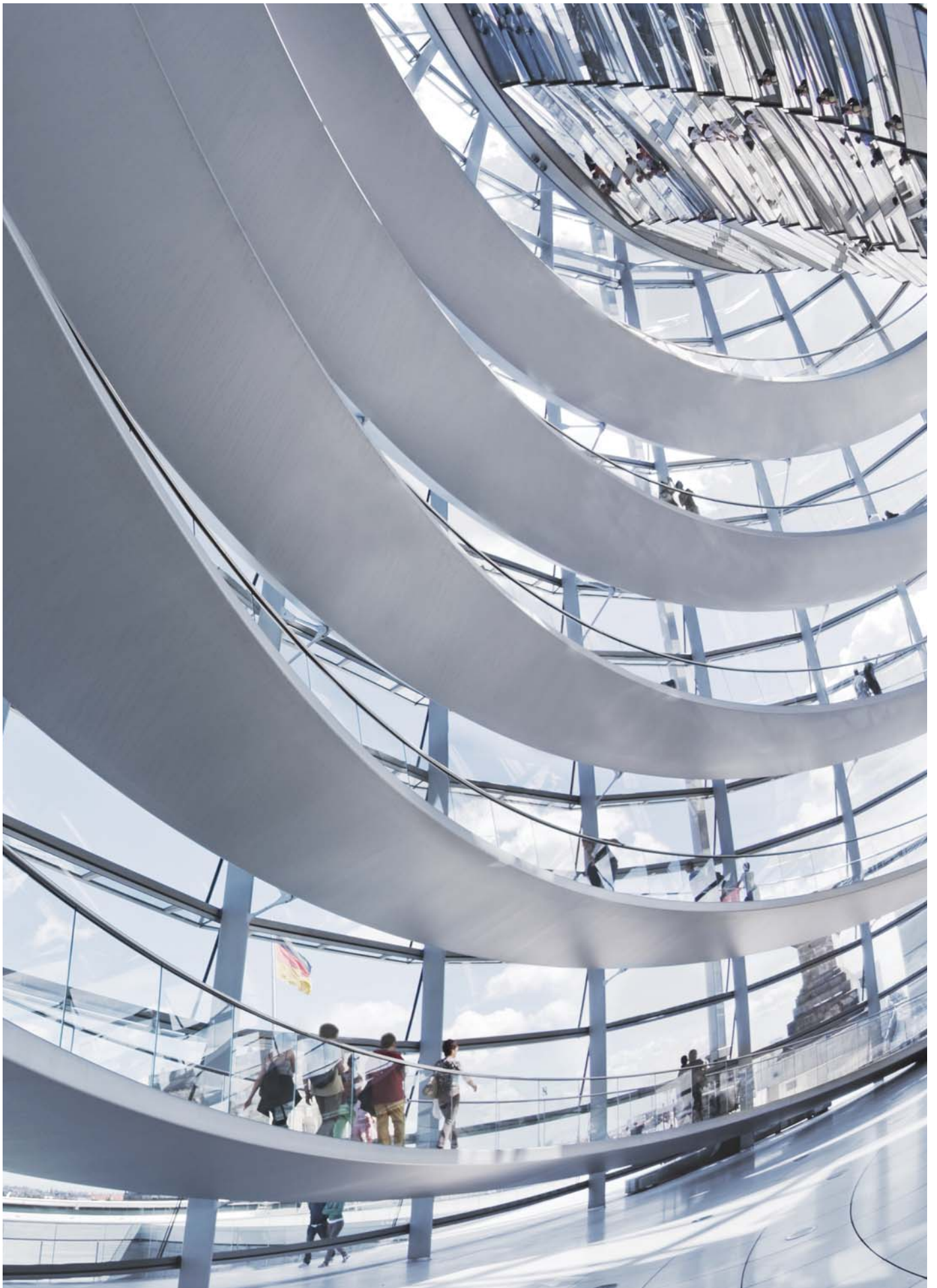

Product Catalogue

Flexible conduit systems for critical power & data cable protection





Flexible conduit systems for critical power & data cable protection

Introduction	1
Non-metallic conduit systems	2
Metallic conduit systems	3
Convenience packs	4
Cutting tools	5
Cable glands & terminal blocks	6
Aquasafe	7
Technical section	8
Index	9

Introduction

Introduction

Company overview	1/2
Quality approvals	1/3
Third party testing & approvals	1/4

Applications

Construction applications	1/5
Machinery applications	1/6
Rail infrastructure applications	1/7
Marine applications	1/8
Mechanical applications	1/9

Introduction

Company overview

1



Adaptaflex flexible conduit systems are used to protect critical power and data cabling. Established in 1972 Adaptaflex has developed into a leading player within the flexible conduit market.

Adaptaflex is one of the market leading flexible conduit system brands that can be found all over the world. Combining innovative design with dedicated manufacture it offers customers one of the world's broadest ranges of cable protection products and solutions. With a choice of over 6000 products the range covers metallic and non-metallic flexible conduit systems for the protection of critical power and data cable.

The system solutions from Adaptaflex need to perform in a wide variety of environments from high temperature to freezing subzero conditions. The products are designed and tested to withstand constant vibrations, water ingress, offer corrosion resistance and are available in halogen free, low smoke and low toxicity materials. An extensive range of engineered solutions are designed to withstand the rigours of some of the most technically demanding markets. So whatever your project involves our experience will provide the answer helping you to specify the correct flexible conduit system.

Markets and industries

Adaptaflex flexible conduit systems are used to protect critical power and data cabling throughout a wide range of markets including:

- Commercial contracting
- Machinery
- Rail / Infrastructure
- Marine
- Mechanical
- Security / CCTV
- Data cabling
- Critical power

Our products are designed and engineered to meet a variety of market application requirements, providing product innovation, saving installation and component costs, improving the quality and the integrity of the end product.

Introduction

Quality approvals



1

Quality approvals

The company's commitment to independent testing across a wide range of applications has led to an impressive range of certifications and quality approvals:

- BSI Kitemark
- BS EN ISO14001 Environmental standard
- IEC 616386 Conduit standard covering the performance characteristics of flexible conduits
- Lloyds Register of shipping type approval for its non-metallic PR, PK and metallic LFH-SP and SPL products way back in 1995
- IP69K, DIN 40050, standard with its Adaptalok range of non metallic fittings
- Offer non-metallic conduit that is fully compliant to the new dual listed UL 1696 standard. Required for any equipment destined for export to the USA and Canada
- The Hi-Spec PEEK range, designed for the most demanding electrical applications in rail infrastructure, underground and public buildings, is the only non-metallic flexible conduit system fully compliant with both BS6583 Class 1A requirement and LUL engineering standard 1-085

Industry standards

As one of the worlds leading flexible conduit system manufacturers, Adaptaflex has achieved many international approvals, for our manufacturing as well as our product ranges.

Adaptaflex are able to use our experience and knowledge to ensure safety and quality levels are maintained now and in the future.



Introduction

Third party testing & approvals

1



Third party testing & approvals

IEC61386 Performance classification standard

Adaptaflex has achieved third party accreditation to the IEC61386 Standard from the British Standards Institution (BSI). IEC61386 conformance guarantees that products meet performance specifications for fatigue life, operating temperature, non-flame propagation, IP ratings amongst other criteria.

BSI Kitemark

Adaptaflex manufacturer to third party accreditation through the BSI Kitemark scheme. The Kitemark is one of the world's premier symbols of trust, integrity and quality. Manufacturers with the Kitemark are an elite club of some of the world's best companies being annually tested to ensure continued compliance. Having the Kitemark associated with our products illustrates that we have satisfied the most rigorous of quality processes.

ISO9001 Quality standard

Adaptaflex conform to ISO 9001:2000, the internationally recognised standard for Quality Management Systems. This standard reflects the procedures and management processes throughout the whole of the company.

BS EN ISO14001 Environmental standard

Controlling the impact of manufacturing activities on the environment is a major challenge. Again Adaptaflex lead the way by being the first conduit manufacturer to comply with this Standard.

We also meet the requirements of EU directive 2002/95/EC on the restriction of the use of certain hazardous substances (RoHS). This forms part of the legislation on waste management and is aligned with the waste electrical and electronic equipment (WEEE). Specifically no lead, mercury, cadmium, hexavalent chromium; polybrominated biphenyls (PBB) or polybrominated diphenyl ethers (PBDE) are used in the manufacture of metallic and non-metallic flexible conduit systems.

Customer support

All our products are backed up by full technical support team, sales teams, customer care team and in-house marketing specialists. All dedicated teams working together to ensure that you have the best of support in the market place.

Applications

Construction applications



1



Construction overview

In these environments there are ever increasing demands not only for quicker and easier to install solutions but also for increased safety and technical performances to meet the specific needs of municipal buildings. The ability to offer product ranges with enhanced low fire hazard properties for safety or overbraiding for security and EMI shielding. Where exposed interiors call for design consideration there is a choice such as conduit in different colours such as white or indifferent materials such as stainless steel to complement interior styling - Adaptaflex have a range to suit.

Typical Applications:

- Office buildings
- Schools
- Hospitals (EMC)
- Retail developments
- Leisure complexes / Sports stadiums

Industry approved

Adaptaflex products are approved by a range of recognised industry standards including:

- BSI Kitemark to IEC61386
- CE marked to the Low Voltage Directive
- Fully compliant to BS7671 Wiring Regulations code of practice

Product recommendation

- Low fire hazard PA conduit systems
- Adaptalok fittings
- LFH-SP Liquid resistant covered flexible steel conduit systems enhanced low fire hazard

Applications

Machinery applications

1



Machinery overview

This market is driven by the needs to meet the best in lean manufacturing. To achieve this every piece of equipment in this sector is pushed for greater efficiency by working more intensely and faster. As a result any conduit installed in these applications will need to provide excellent mechanical strength, flexibility and abrasion resistance in order to supply the best possible solution to provide protection along the entire length of all the moving parts.

In this hardworking environment of both dynamic and static applications, it is essential that any cable management products continue to deliver performance in areas where resistance to oils and chemicals is paramount. Any down time in manufacturing can be very costly so products that can offer high ingress protection are fundamental and Adaptaflex can offer a wide range of solutions to meet all of these needs.

Technology is increasingly being used in modern machine tools and the need to interface conduit to multipin-connectors is escalating. Nylon systems continue to gain popularity in this sector due to their excellent performance, flexibility and low installed cost benefits. For this reason Adaptaflex has developed a wide range of liquid tight connector interfaces in the Adaptalok range.

Typical Applications:

- Metal cutting and fabrication
- Milling machines
- CNC machine tool technology
- Moulding machinery
- Security & CCTV
- Robotics

Industry approved

Adaptaflex products are approved by a range of recognised industry standards including:

- BSI Kitemark to IEC61386
- CE marked to the Low Voltage Directive
- Fully compliant to BS7671 Wiring Regulations code of practice
- UL / CSA
- UR

Product recommendation

- SPL liquid tight conduit systems
- PA conduit systems
- SPUL for machinery USA export
- Overbraided conduit systems
- SPLHC conduit systems
- PI conduit systems
- Adapting fittings
- PADL conduit systems
- ATS fittings

Applications

Rail infrastructure applications



1



SIEMENS



Rail overview

For more than 30 years we have worked with the foremost manufacturers and suppliers of public transportation systems throughout the world. We understand not just the Standards that you need to work to, but also the Industry issues that you face including your customer service delivery expectations.

Our systems need to perform in a wide variety of environments from high temperature to freezing subzero conditions. Our products can withstand constant vibrations, water ingress, offer corrosion resistance and are available in halogen free, low smoke and low toxicity materials. If your project involves rail stations, infrastructure, signalling, tunnels, surveillance or data and information systems our experience will provide the answer helping you to specify the correct flexible conduit system.

Typical Applications:

- Infrastructure projects - Stations, tunnels, signalling
- Low fire hazard systems
- Exposed Locations
- High impact resistance, low temperature flexing
- EMC Protection for safety critical systems
- OEM packages

Industry approved

Adaptaflex products are approved by a range of recognised industry standards including:

- LUL 1-085
- NF F 16-101/102
- Deutsche Bahn (DIN 5510)
- BS6853
- Siemens Transportation
- BSI Kitemark to IEC61386
- CE marked to the Low Voltage Directive
- EN 45545-2

Approvals & standards

- PA conduit systems
- PR enhanced low fire hazard conduit systems
- PF conduit systems
- PK conduit systems
- LFH-SP conduit systems
- CP conduit systems
- IP66/67/68/69k Adaptalok / ATS fittings
- Overbraided systems

Applications

Marine applications

1



Marine overview

Safety and reliability are vital considerations within one of the harshest operational environments to be found. Products specified and installed within this sector have to face the particular damaging effects from the wind, wave and salt spray conditions in exposed areas. Whilst this demands for the most robust of products it also calls for solutions where vibration and temperature extremes add to the challenge.

Adaptaflex offer a broad range of solutions to suit this sector which are abrasion, impact, corrosion and chemical resistant, offering long service life and low fire hazard properties. Utilising Adaptalok sealing systems also offers ingress protection particularly valuable in pressure washing applications and with our specialist insert seal raises the IP rating from IP66 to IP67/68/69K.

Typical Applications:

- Ship / Boat engine rooms
- Ship and dock yards
- Leisure boats and cruisers
- Marina developments
- Ocean going craft

Industry approved

Adaptaflex products are approved by a range of recognised industry standards including:

- Lloyds Register type approved
- UR
- BSI Kitemark to IEC61386
- CE marked to the Low Voltage Directive

Product recommendation

- PA conduit systems
- PR conduit systems
- IP66/67/68/69k Adaptalok ATS™ systems
- Adaptaseal systems
- Stainless steel conduit systems
- SPL conduit systems
- LFH-SP conduit systems

Applications

Mechanical applications



Mechanical overview

Adaptaflex offers a range of products suited for this market, providing abrasion, impact and corrosion resistance and ingress protection. Additionally, Adaptaflex offers a range of high specification systems, braided EMI screen options.

Adaptaflex Applications Engineers offer a breadth of experience gained internationally across all different market sectors. A bespoke design service and expert technical knowledge guarantees that Adaptaflex will find the perfect product solution for your application.

Examples of individual markets served:

- Hoists
- Cranes
- Lifts
- Escalators

Industry approved

Adaptaflex products are approved by a range of recognised industry standards including:

- BSI Kitemark to IEC61386
- CE marked to the Low Voltage Directive
- Fully compliant to BS7671 Wiring Regulations code of practice
- UL / UR
- CSA

Product recommendation

- SPL liquid tight conduit systems
- PA conduit systems
- Overbraided conduit systems
- Stainless steel conduit systems
- SPLHC conduit systems
- PI conduit systems
- Adapting fittings
- ATS fittings

Non-metallic conduit systems

Conduit, fittings & accessories

Non-Metallic Conduit Systems

Quick selection guide	2/2
Introduction	2/5

Non-Metallic Conduit

Type PA	2/6
Type PF	2/8
Type PI	2/9
Type PR	2/10
Type CP	2/10
Type PADL	2/11

Adaptalok Fittings

Type A - Adaptalok	2/12
Type C90 - Adaptalok	2/13
Type 45 - Adaptalok	2/14
Push-in - Adaptalok	2/14
3-Way Coupler - Adaptalok	2/15
Insert Seal - Adaptalok	2/15
Type FL/A - Adaptalok	2/16
Type FL/C90 - Adaptalok	2/16
Type FL/45 - Adaptalok	2/17
Swivel Coupler - Adaptalok	2/17
Type SA - Adaptalok	2/18
Type CS90 - Adaptalok	2/18
Type S45 - Adaptalok	2/19
Type SFA - Adaptalok	2/19
Type CSF90 - Adaptalok	2/20
Type SF45 - Adaptalok	2/20

Adaptalok UNEF Fittings

Type A - Adaptalok	2/21
Type C90 - Adaptalok	2/22
Type 45 - Adaptalok	2/23

Adaptalok Jumbo Fittings

Type FL/A - Adaptalok	2/24
Type SK - Adaptalok	2/24

Adaptalok ATS™ Non-Metallic Conduit Systems

Introduction to Adaptalok ATS™	2/26
--------------------------------	------

Adaptalok ATS™ Fittings

Type A - Adaptalok ATS™	2/27
Type C90 - Adaptalok ATS™	2/28
Type 45 - Adaptalok ATS™	2/29
Type SA - Adaptalok ATS™	2/30
Type CS90 - Adaptalok ATS™	2/30
Type S45 - Adaptalok ATS™	2/31
Type SFA - Adaptalok ATS™	2/31
Type CSF90 - Adaptalok ATS™	2/32
Type SF45 - Adaptalok ATS™	2/32

Adaptalok ATS™ UNEF Fittings

Type SFA - Adaptalok ATS™	2/33
Type CSF90 - Adaptalok ATS™	2/34
Type SF45 - Adaptalok ATS™	2/35

Adaptalok ATS™ IP68/69k Fittings

Swivel Coupler - Adaptalok ATS™	2/36
Type FL/A - Adaptalok ATS™	2/36
Type FL/C90 - Adaptalok ATS™	2/37
Type FL/45 - Adaptalok ATS™	2/37

Adaptalok ATS™ T & Y Piece Fittings

Type T - Adaptalok ATS™	2/38
Type Y - Adaptalok ATS™	2/39

Adaptaseal Fittings

Type A - Adaptaseal	2/40
Type C90 - Adaptaseal	2/40
Type FLC90/FL90 - Adaptaseal	2/41
Type T - Adaptaseal	2/41
Type RK - Adaptaseal	2/42
Type AWB - Adaptaseal	2/42

Adaptaring Fittings

Type A - Adaptaring	2/43
Type C90 - Adaptaring	2/43
Type T - Adaptaring	2/44
Type AWB - Adaptaring	2/44

Korifit Conduit & Fittings

Type KF - Korifit	2/45
Type KC/A - Korifit	2/46
Type KC/C90 - Korifit	2/46
Type KF/A - Korifit	2/47
Coupler - Korifit	2/47

Polypropylene Adaptalok Conduit Systems

Type PP - Polypropylene / Adaptalok	2/48
Type PPA - Polypropylene / Adaptalok	2/48

PVC Xtraflex / RF Fittings

Type XF - PVC / Xtraflex	2/49
Type RF - PVC / RF	2/49
Type A - PVC / XF	2/50
Type C90 - PVC / XF	2/50
Type A - PVC / RF	2/51
Type C90 - PVC / RF	2/51

Non-Metallic Accessories

Type LNP - Nylon Locknut	2/52
Type SW - Thread Sealing Washer	2/52
Type AC - Conduit Clip	2/52
Type GZ - End Sleeve	2/53
Type EC - End Cap	2/53
Type RT - Adaptalok Removal Tool	2/53
Type MB - Manifold Boxes	2/54
Hinged T Pieces	2/55
Hinged Y Pieces	2/56

High-Spec Non-Metallic Conduit Systems

Type PK - Peek	2/57
Type A - Peek	2/57
Type PKTC	2/58
Type PKSS	2/58
Type PRTC	2/59
Type PRSS	2/59
Type A - Hi-Spec	2/60
Type B - Hi-Spec	2/60

Non-metallic conduit systems

Quick selection guide

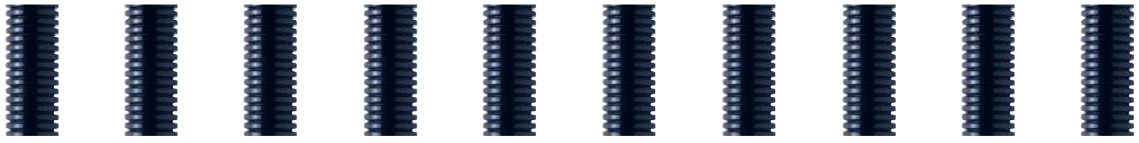

2

Conduit Type	Pitch	Type PA	Type PA	Type PA	Type PA	Type PF	Type PF	Type PI	Type PI	Type PR	Type PADL
Part number	Fine	PAFL	PAFL-S	PAFS	PAFH	PFFS	PFFH	PIFS	PIFH	PRFS	PADL
	Coarse	PACL	PACL-S	PACS	PACH	PFCS	PFCH	PICS	PICH	PRCS	
Conduit weight		Lightweight	Lightweight slit	Standard weight	Heavyweight	Standard weight	Heavyweight	Standard weight	Heavyweight	Standard weight	Standard weight
Conduit material		PA6	PA6	PA6	PA6	PA12	PA12	PA11	PA11	PA6	PA6
Covering/overbraid		-	-	-	-	-	-	-	-	-	-

Conduit colour

Black (BL)	•	•	•	•	•	•	•	•	•	•	•
Grey (GR)	•	-	•	•	-	-	-	•	-	-	-
White (W)	-	-	-	-	-	-	-	-	-	-	-

IP Rating (with appropriate fitting)

IP40	•	-	•	•	-	-	-	•	•	•	•
IP65	-	-	-	-	-	-	-	-	-	-	-
IP66	•	-	•	•	•	•	•	•	•	•	•
IP67	•	-	•	•	•	•	•	•	•	•	•
IP68	•	-	•	•	•	•	•	•	•	•	•
IP69k	-	-	•	-	•	•	•	•	-	•	•

Characteristics

Temperature Range

Static applications (°C)	-40 to +120	-40 to +120	-40 to +120	-40 to +120	-50 to +110	-50 to +110	-50 to +110	-50 to +110	-50 to +110	-40 to +120	-40 to +120
Moving applications (°C)	-5 to +120	-5 to +120	-5 to +120	-5 to +120	-45 to +120	-45 to +120	-45 to +120	-45 to +120	-45 to +120	-5 to +120	-18 to +120
UV resistance	Very high	Very high	Very high	Very high	Very high	Very high	Very high	Very high	Very high	Very high	Very high
Flexibility	High	High	High	Medium	Very high	High	Very high	High	High	High	Medium
Fatigue life	High	High	High	Medium	Very high	High	Very high	Very high	Very high	Medium	Medium
Low fire hazard	-	-	Standard	Standard	Standard	Standard	-	-	-	Enhanced	Standard
Halogen free	•	•	•	•	•	•	•	•	•	•	•
Self extinguishing	•	•	•	•	•	•	•	•	•	•	•
EMI screen	-	-	-	-	-	-	-	-	-	-	-
High mechanical strength	-	-	-	-	-	-	-	-	-	-	-
High abrasion resistance	-	-	•	•	•	•	-	-	-	•	•

Approvals

BSI Kitemark	•	•	•	•	•	•	•	•	•	•	•
CE	•	•	•	•	•	•	•	•	•	•	•
UL / CSA	-	-	-	-	-	-	-	-	-	-	•
DB	•	-	•	•	•	•	•	•	•	•	-
NF F	-	-	•	•	•	•	•	•	•	•	-
Lloyds Register	-	-	•	•	-	-	-	-	-	•	-
LUL 1-085	-	-	•	•	-	-	-	-	-	•	-
UNI CEI 11170	-	-	-	-	•	•	-	-	-	-	-
EN45545-2 to HL2	-	-	-	-	•	•	-	-	-	•	-
EN45545-2 to HL3	-	-	-	-	-	-	-	-	-	•	-

Section 2 / Page No.	2/6	2/6	2/7	2/7	2/8	2/8	2/9	2/9	2/10	2/11
----------------------	-----	-----	-----	-----	-----	-----	-----	-----	------	------



Type CP	Type KF	Type KF	Type KF	Type PP	Type XF	Type RF	Type PK	Type PKTC	Type PKSS	Type PRTC	Type PRSS
CPFM	KFL	KFS	KFM	PPFM	XF	RF	PKFS	PKFSTC	PKFSSS	PRFSTC	PRFSSS
CPCM							PKCS	PKGSTC	PKGSSS	PRCSTC	PRCSSS
Medium weight	Lightweight	Standard weight	Medium weight	Medium weight	Standard weight	Standard weight	Standard weight	Standard weight	Standard weight	Standard weight	Standard weight
CPe	PVCu	PVCu	PVCu	PP	PVC	PVC	PK	PK	PK	PA6	PA6
-	-	-	-	-	Plasticised PVC	Plasticised PVC	-	Tinned copper	Stainless steel	Tinned copper	Stainless steel
•	-	-	•	•	•	•	•	-	-	-	-
-	•	-	-	-	-	•	-	-	-	-	-
-	-	•	-	-	-	-	-	-	-	-	-
•	•	•	•	•	-	-	-	-	-	-	-
•	•	•	•	-	•	-	-	-	-	-	-
•	-	-	-	•	-	-	•	•	•	•	•
•	-	-	-	•	-	•	•	•	•	•	•
•	-	-	-	•	-	-	-	-	-	-	-
•	-	-	-	-	-	-	-	-	-	-	-
-50 to +135	-5 to +60	-5 to +60	-5 to +60	-20 to +90	-5 to +60	-20 to +60	-60 to +260	-60 to +260	-60 to +260	-40 to +120	-40 to +120
-25 to +150	-5 to +60	-5 to +60	-5 to +60	-5 to +105	-5 to +60	-5 to +60	-45 to +260	-45 to +260	-45 to +260	-5 to +120	-5 to +120
Very high	High	High	High	Medium	High	High	Very high	Very high	Very high	Very high	Very high
Very high	Pliable	Pliable	Pliable	High	Very high	Medium	High	High	High	High	High
Very high	Low	Low	Low	Medium	Medium	Medium	High	High	High	Medium	Medium
Standard	-	-	-	-	-	-	Super	Super	Super	Enhanced	Enhanced
•	-	-	-	•	-	-	•	•	•	•	•
•	•	•	•	-	•	•	•	•	•	•	•
-	-	-	-	-	-	-	-	High	Standard	High	Standard
-	-	-	-	-	-	-	-	•	•	•	•
-	-	-	-	-	-	-	•	•	•	•	•
•	•	•	•	•	•	•	•	•	•	•	•
-	-	-	-	-	-	-	-	-	-	-	-
-	-	-	-	-	-	-	-	-	-	•	•
•	-	-	-	-	-	-	•	•	•	•	•
-	-	-	-	-	-	-	-	-	-	•	•
-	-	-	-	-	-	-	•	•	•	•	•
-	-	-	-	-	-	-	-	-	-	-	-
-	-	-	-	-	-	-	-	-	-	-	-
-	-	-	-	-	-	-	-	-	-	-	-
2/10	2/45	2/45	2/45	2/48	2/49	2/49	2/57	2/58	2/58	2/59	2/59



Non-metallic conduit systems

Introduction

Range overview

Adaptaflex have more than 20 different types of non-metallic conduit systems all providing different technical properties for your cable management applications.

Our Conduit range is available in many different materials, ranging from lightweight to heavyweight with nominal conduit sizes from 10mm right up to the Jumbo size of 106mm.

For more demanding applications, there is a wide-ranging high specification series of conduit with enhanced low fire hazard properties, EMI screening and incorporating high fatigue life. Overbraided options are available for use in abrasive environments.

Standard product is manufactured in a wide range of materials. The corrugated construction provides good flexibility and low weight. Additionally, a range of fittings are specifically designed to maintain system integrity including the popular and easy to fit Adaptalok system. Fitting types are available in straight, 90°, 45°, with metric, PG, PF, & NPT threads.

Advantages:

- Non metallic conduits do not corrode (rust)
- Wider variety of fittings - much larger solutions choice
- Quicker to install (cut & assemble fittings)
- Lighter in weight
- Better fatigue life
- Return to shape



Many of our conduit systems have industry recognised approvals including British Kitemark, CE Approval, UL 1696, NF, LUL, DB, Lloyds Register amongst others.



Non-metallic conduit systems

Type PA

2



Type PA
Lightweight Conduit

Type PA

Lightweight Conduit / Materials: Polyamide (Nylon) 6 / Colour: Black (BL), Grey (GR)

Part No.	Nominal Conduit Size	NW Conduit Size	Conduit Pitch	Outside Diameter	Inside Diameter	Min. Bend Radius	Reel Length
PAFL13	13mm	10	Fine	13.0mm	10.0mm	25mm	50m
PAFL16	16mm	13	Fine	15.8mm	11.9mm	35mm	50m
PAFL21	21mm	17	Fine	21.2mm	16.8mm	45mm	50m
PAFL28	28mm	23	Coarse	28.5mm	22.2mm	50mm	50m
PAFL34	34mm	29	Coarse	34.5mm	27.9mm	60mm	50m
PAFL42	42mm	36	Coarse	42.5mm	35.2mm	65mm	25m
PAFL54	54mm	48	Coarse	54.5mm	46.9mm	75mm	25m

To order quote part number, colour & reel length, e.g. PAFL13/BL/50M

Approvals



IP Rating	Appropriate Fitting	Temperature Range	UV Resistance
For use with: Adaptalok / ATS / Adaptaring / Adaptaseal		Static Applications: -40°C to +120°C Moving Applications: -5°C to +120°C	Very High
IP40	Adaptaring	Flexibility & Fatigue Life	
IP65	N/A	High Flexibility - High Fatigue Life	
IP66	Adaptalok, ATS or Adaptaseal	Fire Performance & EMI Screen	
IP67	Adaptalok + ALS Seal or ATS, Adaptaseal	Self Extinguishing	
IP68	Adaptalok + ALS Seal or ATS, Adaptaseal	Halogen Free	
IP69K	N/A		



Type PA
Lightweight Slit Conduit

Type PA-Slit

Lightweight Slit Conduit / Materials: Polyamide (Nylon) 6 / Colour: Black (BL) Only

Part No.	Nominal Conduit Size	NW Conduit Size	Conduit Pitch	Outside Diameter	Inside Diameter	Min. Bend Radius	Reel Length
PAFL13-S	13mm	10	Fine	13.0mm	10.0mm	25mm	50m
PAFL16-S	16mm	13	Fine	15.8mm	11.9mm	35mm	50m
PAFL21-S	21mm	17	Fine	21.2mm	16.8mm	45mm	50m
PAFL28-S	28mm	23	Coarse	28.5mm	22.2mm	50mm	50m
PAFL34-S	34mm	29	Coarse	34.5mm	27.9mm	60mm	50m
PAFL42-S	42mm	36	Coarse	42.5mm	35.2mm	65mm	25m
PAFL54-S	54mm	48	Coarse	54.5mm	46.9mm	75mm	25m

To order quote part number, colour & reel length, e.g. PAFL13-S/BL/50M

Approvals



IP Rating	Appropriate Fitting	Temperature Range	UV Resistance
For use with: Adaptalok / ATS / Adaptaring / Adaptaseal		Static Applications: -40°C to +120°C Moving Applications: -5°C to +120°C	Very High
IP40	N/A	Flexibility & Fatigue Life	
IP65	N/A	High Flexibility - High Fatigue Life	
IP66	N/A	Fire Performance & EMI Screen	
IP67	N/A	Self Extinguishing	
IP68	N/A	Halogen Free	
IP69K	N/A		

Non-metallic conduit systems

Type PA



Type PA
Standard Weight Conduit

Type PA

Standard Weight Conduit / **Materials:** Polyamide (Nylon) 6 / **Colour:** Black (BL), Grey (GR)

Part No.	Nominal Conduit Size	NW Conduit Size	Conduit Pitch	Outside Diameter	Inside Diameter	Min. Bend Radius	Reel Length (BL)	(GR)
PAFS10	10mm	7.5	Fine	10.0mm	6.5mm	15mm	50m	50m
PAFS13	13mm	10	Fine	13.0mm	9.6mm	25mm	50m	50m
PAFS16	16mm	13	Fine	15.8mm	11.8mm	35mm	10/25/50m	50m
PAFS21	21mm	17	Fine	21.2mm	16.5mm	45mm	10/25/50m	50m
PAFS28	28mm	23	Fine	28.5mm	22.6mm	50mm	10/25/50m	50m
PACS28	28mm	23	Coarse	28.5mm	21.7mm	50mm	10/25/50m	50m
PAFS34	34mm	29	Fine	34.5mm	28.8mm	60mm	10/25/50m	50m
PACS34	34mm	29	Coarse	34.5mm	27.7mm	60mm	10/25/50m	50m
PACS42	42mm	36	Coarse	42.5mm	35.2mm	65mm	10/25m	25m
PACS54	54mm	48	Coarse	54.5mm	46.5mm	75mm	10/25m	25m
PACS80	80mm	70	Coarse	79.3mm	67.0mm	160mm	10m	10m
PACS106	106mm	95	Coarse	106.0mm	91.5mm	210mm	10m	10m

To order quote part number, colour & reel length, e.g. PAFS13/BL/50M

Approvals



IP Rating	Appropriate Fitting	Temperature Range	UV Resistance
For use with: Adaptalok / ATS / Adapting / Adaptaseal / Jumbo		Static Applications: -40°C to +120°C Moving Applications: -5°C to +120°C	Very High
IP40	Adapting & Jumbo	Flexibility & Fatigue Life High Flexibility - High Fatigue Life	
IP65	Jumbo + SK Seal		
IP66	Adaptalok, ATS or Adaptaseal	Fire Performance & EMI Screen Self Extinguishing	
IP67	Adaptalok + ALS Seal or ATS, Adaptaseal		
IP68	Adaptalok + ALS Seal or ATS, Adaptaseal	Halogen Free	
IP69K	Adaptalok + ALS Seal or ATS		



Type PA
Heavyweight Conduit

Type PA

Heavyweight Conduit / **Materials:** Polyamide (Nylon) 6 / **Colour:** Black (BL), Grey (GR)

Part No.	Nominal Conduit Size	NW Conduit Size	Conduit Pitch	Outside Diameter	Inside Diameter	Min. Bend Radius	Reel Length
PAFH13	13mm	10	Fine	13.0mm	9.0mm	35mm	50m
PAFH16	16mm	13	Fine	15.8mm	11.3mm	45mm	50m
PACH21	21mm	17	Coarse	21.2mm	14.5mm	60mm	50m
PACH28	28mm	23	Coarse	28.5mm	21.3mm	70mm	50m
PACH34	34mm	29	Coarse	34.5mm	26.8mm	75mm	50m
PACH42	42mm	36	Coarse	42.5mm	34.6mm	90mm	25m
PACH54	54mm	48	Coarse	54.5mm	46.0mm	95mm	25m

To order quote part number, colour & reel length, e.g. PAFH13/BL/50M

Approvals



IP Rating	Appropriate Fitting	Temperature Range	UV Resistance
For use with: Adaptalok / ATS / Adapting / Adaptaseal		Static Applications: -40°C to +120°C Moving Applications: -5°C to +120°C	Very High
IP40	Adapting	Flexibility & Fatigue Life Medium Flexibility - Medium Fatigue Life	
IP65	N/A		
IP66	Adaptalok, ATS or Adaptaseal	Fire Performance & EMI Screen Self Extinguishing	
IP67	Adaptalok + ALS Seal or ATS, Adaptaseal		
IP68	Adaptalok + ALS Seal or ATS, Adaptaseal	Halogen Free	
IP69K	N/A		

Non-metallic conduit systems

Type PF

2



Type PF
Standard Weight Conduit

Type PF

Standard Weight Conduit / **Materials:** Modified Polyamide 12 / **Colour:** Black (BL) Only

Part No.	Nominal Conduit Size	NW Conduit Size	Conduit Pitch	Outside Diameter	Inside Diameter	Min. Bend Radius	Reel Length
PFFS10	10mm	7.5	Fine	10.0mm	6.2mm	20mm	50m
PFFS13	13mm	10	Fine	13.0mm	9.9mm	30mm	50m
PFFS16	16mm	13	Fine	15.8mm	11.7mm	35mm	50m
PFFS21	21mm	17	Fine	21.2mm	16.6mm	40mm	50m
PFCS28	28mm	23	Coarse	28.5mm	21.7mm	50mm	50m
PFCS34	34mm	29	Coarse	34.5mm	27.7mm	60mm	25m
PFCS42	42mm	36	Coarse	42.5mm	35.5mm	65mm	25m
PFCS54	54mm	48	Coarse	54.5mm	46.6mm	75mm	25m

To order quote part number, colour & reel length, e.g. PFFS13/BL/50M

Approvals



IP Rating	Appropriate Fitting	Temperature Range	UV Resistance
For use with: Adaptalok / ATS / Adapting / ALS		Static Applications: -50°C to +110°C	Very High
IP40	Adapting	Moving Applications: -45°C to +120°C	
IP65	N/A	Flexibility & Fatigue Life	
IP66	ATS, Adaptalok	Very High Flexibility - Very High Fatigue Life	
IP67	ATS, Adaptalok + ALS Seal	Fire Performance & EMI Screen	
IP68	ATS, Adaptalok + ALS Seal	Self Extinguishing	
IP69K	ATS, Adaptalok + ALS Seal	Halogen Free	



Type PF
Heavyweight Conduit

Type PF

Heavyweight Conduit / **Materials:** Modified Polyamide 12 / **Colour:** Black (BL) Only

Part No.	Nominal Conduit Size	NW Conduit Size	Conduit Pitch	Outside Diameter	Inside Diameter	Min. Bend Radius	Reel Length
PFFH13	13mm	10	Fine	13.0mm	9.7mm	40mm	50m
PFFH16	16mm	13	Fine	15.8mm	11.5mm	45mm	50m
PFCH21	21mm	17	Coarse	21.2mm	15.3mm	50mm	50m
PFCH28	28mm	23	Coarse	28.5mm	21.5mm	60mm	50m
PFCH34	34mm	29	Coarse	34.5mm	27.5mm	70mm	25m
PFCH42	42mm	36	Coarse	42.5mm	35.5mm	75mm	25m
PFCH54	54mm	48	Coarse	54.5mm	46.4mm	85mm	25m

To order quote part number, colour & reel length, e.g. PFFH13/BL/50M

Approvals



IP Rating	Appropriate Fitting	Temperature Range	UV Resistance
For use with: Adaptalok / ATS / Adapting / ALS		Static Applications: -50°C to +110°C	Very High
IP40	Adapting	Moving Applications: -45°C to +120°C	
IP65	N/A	Flexibility & Fatigue Life	
IP66	ATS, Adaptalok	High Flexibility - High Fatigue Life	
IP67	ATS, Adaptalok + ALS Seal	Fire Performance & EMI Screen	
IP68	ATS, Adaptalok + ALS Seal	Self Extinguishing	
IP69K	ATS, Adaptalok + ALS Seal	Halogen Free	

Non-metallic conduit systems

Type PI



Type PI
Standard Weight Conduit

Type PI

Standard Weight Conduit / **Materials:** Modified Polyamide 11 / **Colour:** Black (BL), Grey (GR)

Part No.	Nominal Conduit Size	NW Conduit Size	Conduit Pitch	Outside Diameter	Inside Diameter	Min. Bend Radius	Reel Length (BL)
PIFS10	10mm	7.5	Fine	10.0mm	6.2mm	15mm	50m
PIFS13	13mm	10	Fine	13.0mm	9.9mm	25mm	50m
PIFS16	16mm	13	Fine	15.8mm	11.7mm	30mm	50m
PIFS21	21mm	17	Fine	21.2mm	16.6mm	35mm	50m
PICS28	28mm	23	Coarse	28.5mm	21.7mm	45mm	50m
PICS34	34mm	29	Coarse	34.5mm	27.7mm	55mm	25m
PICS42	42mm	36	Coarse	42.5mm	35.5mm	60mm	25m
PICS54	54mm	48	Coarse	54.5mm	46.6mm	70mm	25m
PICS80	80mm	70	Coarse	79.3mm	67.0mm	160mm	10m
PICS106	106mm	95	Coarse	106.0mm	91.0mm	210mm	10m

To order quote part number, colour & reel length, e.g. PIFS13/BL/50M

Approvals



NF

IP Rating	Appropriate Fitting	Temperature Range	UV Resistance
For use with: Adaptalok / ATS / Adapting / Adaptaseal / Jumbo		Static Applications: -50°C to +110°C Moving Applications: -45°C to +120°C	Very High
IP40	Adapting & Jumbo		
IP65	Jumbo + SK Seal	Flexibility & Fatigue Life	
IP66	Adaptalok, ATS or Adaptaseal	Very High Flexibility - Very High Fatigue Life	
IP67	Adaptalok + ALS Seal or ATS, Adaptaseal	Fire Performance & EMI Screen	
IP68	Adaptalok + ALS Seal or ATS, Adaptaseal	Self Extinguishing	
IP69K	Adaptalok + ALS Seal or ATS	Halogen Free	



Type PI
Heavyweight Conduit

Type PI

Heavyweight Conduit / **Materials:** Modified Polyamide 11 / **Colour:** Black (BL) Only

Part No.	Nominal Conduit Size	NW Conduit Size	Conduit Pitch	Outside Diameter	Inside Diameter	Min. Bend Radius	Reel Length
PIFH13	13mm	10	Fine	13.0mm	9.7mm	30mm	50m
PIFH16	16mm	13	Fine	15.8mm	11.5mm	35mm	50m
PICH21	21mm	17	Coarse	21.2mm	15.3mm	40mm	50m
PICH28	28mm	23	Coarse	28.5mm	21.5mm	50mm	50m
PICH34	34mm	29	Coarse	34.5mm	27.5mm	60mm	25m
PICH42	42mm	36	Coarse	42.5mm	35.3mm	65mm	25m
PICH54	54mm	48	Coarse	54.5mm	46.4mm	75mm	25m

To order quote part number, colour & reel length, e.g. PIFH13/BL/50M

Approvals



NF

IP Rating	Appropriate Fitting	Temperature Range	UV Resistance
For use with: Adaptalok / ATS / Adapting / Adaptaseal		Static Applications: -50°C to +110°C Moving Applications: -45°C to +120°C	Very High
IP40	Adapting		
IP65	N/A	Flexibility & Fatigue Life	
IP66	Adaptalok, ATS or Adaptaseal	High Flexibility - Very High Fatigue Life	
IP67	Adaptalok + ALS Seal or ATS, Adaptaseal	Fire Performance & EMI Screen	
IP68	Adaptalok + ALS Seal or ATS, Adaptaseal	Self Extinguishing	
IP69K	N/A	Halogen Free	

Non-metallic conduit systems

Type PR & CP

2



Type PR
Standard Weight Conduit

Type PR

Standard Weight Conduit / **Materials:** Modified Polyamide (Nylon) 6 / **Colour:** Black (BL) Only

Part No.	Nominal Conduit Size	NW Conduit Size	Conduit Pitch	Outside Diameter	Inside Diameter	Min. Bend Radius	Reel Length
PRFS13	13mm	10	Fine	13.0mm	9.4mm	35mm	50m
PRFS16	16mm	13	Fine	15.8mm	11.7mm	45mm	50m
PRFS21	21mm	17	Fine	21.2mm	16.6mm	60mm	50m
PRCS21	21mm	17	Coarse	21.2mm	14.7mm	60mm	50m
PRCS28	28mm	23	Coarse	28.5mm	21.7mm	70mm	50m
PRCS34	34mm	29	Coarse	34.5mm	27.7mm	75mm	50m
PRCS42	42mm	36	Coarse	42.5mm	35.1mm	90mm	25m
PRCS54	54mm	48	Coarse	54.5mm	46.6mm	95mm	25m

To order quote part number, colour & reel length, e.g. PRFS13/BL/50M

Approvals



EN45545-2 HL3 - R22 & R23

IP Rating	Appropriate Fitting	Temperature Range	UV Resistance
For use with: Adaptalok / ATS / Adapting / Adaptaseal		Static Applications: -40°C to +120°C	Very High
IP40	Adapting	Moving Applications: -5°C to +120°C	
IP65	N/A		
IP66	Adaptalok or Adaptaseal		
IP67	Adaptalok + ALS Seal or Adaptaseal		
IP68	Adaptalok + ALS Seal or Adaptaseal		
IP69K	Adaptalok + ALS Seal		

Flexibility & Fatigue Life

High Flexibility - Medium Fatigue Life

Fire Performance & EMI Screen

Self Extinguishing

Halogen Free



Type CP
Medium Weight Conduit

Type CP

Medium Weight Conduit / **Materials:** Polyester / **Colour:** Black (BL) Only

Part No.	Nominal Conduit Size	NW Conduit Size	Conduit Pitch	Outside Diameter	Inside Diameter	Min. Bend Radius	Reel Length
CPFM13	13mm	10	Fine	13.0mm	9.5mm	25mm	50m
CPFM16	16mm	13	Fine	15.8mm	11.3mm	30mm	50m
CPFM21	21mm	17	Fine	21.2mm	16.0mm	35mm	50m
CPCM28	28mm	23	Coarse	28.5mm	21.3mm	45mm	50m
CPCM34	34mm	29	Coarse	34.5mm	27.2mm	55mm	50m
CPCM42	42mm	36	Coarse	42.5mm	34.2mm	60mm	25m
CPCM54	54mm	48	Coarse	54.5mm	46.0mm	70mm	25m

To order quote part number, colour & reel length, e.g. CPFM13/BL/50M

Approvals



IP Rating	Appropriate Fitting	Temperature Range	UV Resistance
For use with: Adaptalok / Adaptaseal		Static Applications: -50°C to +135°C	Very High
IP40	N/A	Moving Applications: -25°C to +150°C	
IP65	N/A		
IP66	Adaptalok or Adaptaseal		
IP67	Adaptalok + ALS Seal & Adaptaseal		
IP68	Adaptalok + ALS Seal & Adaptaseal		
IP69K	Adaptalok + ALS Seal		

Flexibility & Fatigue Life

Very High Flexibility - Very High Fatigue Life

Fire Performance & EMI Screen

Self Extinguishing

Halogen Free



Non-metallic conduit systems

Type PADL



Type PADL
Standard Weight Conduit

Type PADL

Standard Weight Conduit / **Materials:** Modified Polyamide (Nylon) 6 / **Colour:** Black (BL) Only

Part No.	Nominal Conduit Size	NW Conduit Size	Conduit Pitch	Outside Diameter	Inside Diameter	Min. Bend Radius	Reel Length
PADL16	16mm	13	Coarse	15.8mm	11.3mm	45mm	50m or 100ft
PADL21	21mm	17	Coarse	21.2mm	14.5mm	60mm	50m or 100ft
PADL28	28mm	23	Coarse	28.5mm	22.6mm	70mm	50m or 100ft
PADL34	34mm	29	Coarse	34.5mm	27.7mm	75mm	100ft
PADL42	42mm	36	Coarse	42.5mm	35.2mm	80mm	100ft
PADL54	54mm	48	Coarse	54.5mm	46.0mm	95mm	100ft

To order quote part number, colour & reel length, e.g. PADL16/BL/50M

Approvals



IP Rating	Appropriate Fitting	Temperature Range	UV Resistance
For use with: Adaptalok / ATS		Static Applications: -40°C to +120°C Moving Applications: -18°C to +120°C	Very High
IP40	N/A	Flexibility & Fatigue Life Medium Flexibility - Medium Fatigue Life	
IP65	N/A		
IP66	AL or ATS	Fire Performance & EMI Screen Self Extinguishing Halogen Free	
IP67	AL + ALS Seal or ATS		
IP68	AL + ALS Seal or ATS		
IP69K	AL + ALS Seal or ATS		



Non-metallic conduit systems

Type A - Adaptalok

2



Type A
Straight Fitting

Type A - Adaptalok

Straight Fitting - Fixed External Male Thread / For insertion into knockouts using a locknut. Locknut supplied with METRIC THREAD ONLY

Materials: Polyamide (Nylon) 66 / **Colour:** Black (BL), Grey (GR)

Part No.	Nominal Conduit Size	Metric Thread	Part No.	Nominal Conduit Size	PG Thread
AL10/M12/A	10mm	M16	AL10/PG7/A	10mm	PG7
			AL10/PG9/A	10mm	PG9
AL13/M16/A	13mm	M16	AL13/PG9/A	13mm	PG9
AL13/M20/A	13mm	M20	AL13/PG11/A	13mm	PG11
			AL13/PG13/A	13mm	PG13,5
AL16/M16/A	16mm	M16	AL16/PG9/A	16mm	PG9
AL16/M20/A	16mm	M20	AL16/PG11/A	16mm	PG11
			AL16/PG13/A	16mm	PG13,5
			AL16/PG16/A	16mm	PG16
AL21/M20/A	21mm	M20	AL21/PG11/A	21mm	PG11
			AL21/PG13/A	21mm	PG13,5
AL21/M25/A	21mm	M25	AL21/PG16/A	21mm	PG16
AL28/M25/A	28mm	M25	AL28/PG21/A	28mm	PG21
AL28/M32/A	28mm	M32			
AL34/M32/A	34mm	M32	AL34/PG29/A	34mm	PG29
AL34/M40/A	34mm	M40			
AL42/M40/A	42mm	M40	AL42/PG36/A	42mm	PG36
AL42/M50/A	42mm	M50			
AL54/M50/A	54mm	M50	AL54/PG48/A	54mm	PG48
AL54/M63/A	54mm	M63			

Part No.	Nominal Conduit Size	PF Thread	Part No.	Nominal Conduit Size	NPT Thread
AL10/PF025/A	10mm	1/4"	AL13/038/A	13mm	3/8"
AL13/PF038/A	13mm	3/8"	AL16/038/A	16mm	3/8"
AL16/PF038/A	16mm	3/8"	AL16/050/A	16mm	1/2"
AL16/PF050/A	16mm	1/2"	AL21/050/A	21mm	1/2"
AL21/PF050/A	21mm	1/2"	AL28/075/A	28mm	3/4"
AL28/PF075/A	28mm	3/4"	AL34/100/A	34mm	1"
AL34/PF100/A	34mm	1"	AL42/125/A	42mm	1 1/4"
AL42/PF125/A	42mm	1 1/4"	AL54/150/A	54mm	1 1/2"
AL54/PF150/A	54mm	1 1/2"			
AL54/PF200/A	54mm	2"			

To order quote part number & body colour, e.g. AL10/M12/A/BL

Approvals



IP Rating

Appropriate Conduit

For use with: Type PA / PI / CP / PR / PF

IP66	Yes
IP67	Yes + ALS Seal
IP68	Yes + ALS Seal
IP69K	Yes + ALS Seal

Temperature Range

Static Applications: -50°C to +120°C

Moving Applications: -45°C to +120°C

Fitting Characteristics



Non-metallic conduit systems

Type C90 - Adaptalok



Type C90
90° Elbow Fitting

Type C90 - Adaptalok

90° Elbow Fitting - Fixed External Male Thread / For insertion into knockouts using a locknut. Locknut supplied with METRIC THREAD ONLY

Materials: Polyamide (Nylon) 66 / Colour: Black (BL), Grey (GR)

Part No.	Nominal Conduit Size	Metric Thread	Part No.	Nominal Conduit Size	PG Thread
AL10/M12/C90	10mm	M12	AL10/PG7/C90	10mm	PG7
AL13/M16/C90	13mm	M16	AL13/PG9/C90	13mm	PG9
AL16/M16/C90	16mm	M16	AL16/PG9/C90	16mm	PG9
AL16/M20/C90	16mm	M20	AL16/PG11/C90	16mm	PG11
			AL16/PG13/C90	16mm	PG13,5
AL21/M20/C90	21mm	M20	AL21/PG13/C90	21mm	PG13,5
			AL21/PG16/C90	21mm	PG16
AL28/M25/C90	28mm	M25	AL28/PG21/C90	28mm	PG21
AL34/M32/C90	34mm	M32	AL34/PG29/C90	34mm	PG29
AL42/M40/C90	42mm	M40	AL42/PG36/C90	42mm	PG36
AL54/M50/C90	54mm	M50	AL54/PG48/C90	54mm	PG48
AL54/M63/C90	54mm	M63			

Part No.	Nominal Conduit Size	PF Thread	Part No.	Nominal Conduit Size	NPT Thread
AL13/PF038/C90	13mm	3/8"	AL13/038/C90	13mm	3/8"
AL16/PF038/C90	16mm	3/8"	AL16/038/C90	16mm	3/8"
AL16/PF050/C90	16mm	1/2"	AL16/050/C90	16mm	1/2"
AL21/PF050/C90	21mm	1/2"	AL21/050/C90	21mm	1/2"
AL28/PF075/C90	28mm	3/4"	AL28/075/C90	28mm	3/4"
AL34/PF100/C90	34mm	1"	AL34/100/C90	34mm	1"
AL42/PF125/C90	42mm	1 1/4"	AL42/125/C90	42mm	1 1/4"
AL54/PF150/C90	54mm	1 1/2"	AL54/150/C90	54mm	1 1/2"
AL54/PF200/C90	54mm	2"	AL54/200/C90	54mm	2"

To order quote part number & body colour, e.g. AL16/M20/C90/BL

Approvals



IP Rating

For use with: Type PA / PI / CP / PR / PF

IP Rating	Appropriate Conduit
IP66	Yes
IP67	Yes + ALS Seal
IP68	Yes + ALS Seal
IP69K	Yes + ALS Seal

Temperature Range

Static Applications: -50°C to +120°C
Moving Applications: -45°C to +120°C

Non-metallic conduit systems

Type 45 & Push-in - Adaptalok

2



Type 45
45° Elbow Fitting

Type 45 - Adaptalok

45° Elbow Fitting - Fixed External Male Thread / For insertion into knockouts using a locknut. Locknut supplied with METRIC THREAD ONLY

Materials: Polyamide (Nylon) 66 / **Colour:** Black (BL), Grey (GR)

Part No.	Nominal Conduit Size	Metric Thread	Part No.	Nominal Conduit Size	PG Thread
AL13/M16/45	13mm	M16	AL13/PG9/45	13mm	PG9
AL16/M16/45	16mm	M16	AL16/PG11/45	16mm	PG11
AL16/M20/45	16mm	M20	AL16/PG13/45	16mm	PG13,5
AL21/M20/45	21mm	M20	AL21/PG13/45	21mm	PG13,5
			AL21/PG16/45	21mm	PG16
AL28/M25/45	28mm	M25	AL28/PG21/45	28mm	PG21
AL34/M32/45	34mm	M32	AL34/PG29/45	34mm	PG29
AL42/M50/45	42mm	M40	AL42/PG36/45	42mm	PG36
AL54/M50/45	54mm	M50	AL54/PG48/45	54mm	PG48
AL54/M63/45	54mm	M63			

To order quote part number & body colour, e.g. AL21/M20/45/BL

Approvals



IP Rating

Appropriate Conduit

Temperature Range

For use with: Type PA / PI / CP / PR / PF

Static Applications: -50°C to +120°C

IP66	Yes
IP67	Yes + ALS Seal
IP68	Yes + ALS Seal
IP69K	Yes + ALS Seal

Moving Applications: -45°C to +120°C



Push-in
Straight Fitting

Push-in - Adaptalok

Straight Fitting / Inserts into a 20mm knockout, panel thickness up to 4mm, no locknut required

Materials: Polyamide (Nylon) 66 / **Colour:** Black (BL), Grey (GR)

Part No.	Nominal Conduit Size
AL16/KM20/A	16mm
AL21/KM20/A	21mm

To order quote part number & body colour, e.g. AL21/KM20/A/BL

Approvals



IP Rating

Appropriate Conduit

Temperature Range

For use with: Type PA / PI / CP / PR / PF

Static Applications: -50°C to +120°C

IP40	Yes
IP66	N/A
IP67	N/A
IP68	N/A
IP69K	N/A

Moving Applications: -45°C to +120°C

Non-metallic conduit systems

3-Way Coupler & Insert Seal - Adaptalok



3-Way Coupler
3-Way PA66 Fitting

3-Way Coupler - Adaptalok

3-Way PA66 Fitting / For coupling three corrugated flexible conduits

Materials: Polyamide (Nylon) 66 / **Colour:** Black (BL), Grey (GR)

Part No.	Nominal Conduit Size Combination
AL131010/Y	13x10x10mm
AL161313/Y	16x13x13mm
AL211616/Y	21x16x16mm
AL282121/Y	28x21x21mm

To order quote part number & body colour, e.g. AL131010/Y/BL

Approvals



IP Rating	Appropriate Conduit	Temperature Range
For use with: Type PA / PI / CP / PR / PF / PK		Static Applications: -50°C to +120°C
IP66	Yes	Moving Applications: -45°C to +120°C
IP67	Yes + ALS Seal	
IP68	Yes + ALS Seal	
IP69K	Yes + ALS Seal	



Insert Seal
IP67/68/69k Insert Seal

Insert Seal - Adaptalok

IP67/68/69k Insert Seal / Suitable for standard weight PA/PI/PR conduit (Black or Grey)

Materials: Thermoplastic Elastomer / **Colour:** Yellow (Y) Only

Part No.	Conduit Pitch
ALS13/F	Fine
ALS16/F	Fine
ALS21/F	Fine
ALS28/C	Coarse
ALS34/C	Coarse
ALS42/C	Coarse
ALS54/C	Coarse

To order quote part number, e.g. ALS13/F

Note: Seal needs to be inserted into the appropriate conduit to upgrade fitting system

Approvals



IP Rating	Appropriate Conduit	Temperature Range
For use with: Type PA / PI / CP / PR / PF / PK		Static Applications: -50°C to +120°C
IP66	N/A	Moving Applications: -45°C to +120°C
IP67	Yes	
IP68	Yes (1.1 bar 35mins)	
IP69K	Yes (DIN 40050)	

Non-metallic conduit systems

Type FL/A, FL/C90 & FL/90 - Adaptalok

2



Type FL/A
Straight Panel Mounting
Swivel Flange

Type FL/A - Adaptalok

Straight Panel Mounting Swivel Flange / With integral face seal

Materials: Polyamide (Nylon) 66 / Colour: Black (BL), Grey (GR)

Part No.	Nominal Conduit Size
AL16/FL/A	16mm
AL21/FL/A	21mm
AL28/FL/A	28mm
AL54/FL/A	54mm

To order quote part number & body colour, e.g. AL16/FL/A/BL

Approvals



IP Rating	Appropriate Conduit	Temperature Range
For use with: Type PA / PI / CP / PR / PF		
IP66	Yes	Static Applications: -50°C to +120°C Moving Applications: -45°C to +120°C
IP67	Yes + ALS Seal	Fitting Characteristics
IP68	Yes + ALS Seal	
IP69K	Yes + ALS Seal	



Type FL/C90
90° Elbow Body

Type FL/C90 - Adaptalok

90° Elbow Body - Panel Mount Swivel Flange / For panel mounting via 2 hole fixing & integral face seal

Materials: Polyamide (Nylon) 66 / Colour: Black (BL), Grey (GR)

Part No.	Nominal Conduit Size
AL13/FL/C90	13mm
AL16/FL/C90	16mm
AL21/FL/C90	21mm
AL28/FL/C90	28mm

To order quote part number & body colour, e.g. AL13/FL/C90/BL



Type FL/90
90° Elbow Fitting

Type FL/90 - Adaptalok

90° Elbow Fitting - Panel Mount Flange / For panel mounting via 4 hole fixing & integral face seal

Materials: Polyamide (Nylon) 66 / Colour: Black (BL), Grey (GR)

Part No.	Nominal Conduit Size
AL34/FL/90	34mm
AL42/FL/90	42mm
AL54/FL/90	54mm

To order quote part number & body colour, e.g. AL34/FL/C90/BL

Approvals



IP Rating	Appropriate Conduit	Temperature Range
For use with: Type PA / PI / CP / PR / PF		
IP66	Yes	Static Applications: -50°C to +120°C Moving Applications: -45°C to +120°C
IP67	Yes + ALS Seal	Fitting Characteristics (FLC/90 ONLY)
IP68	Yes + ALS Seal	
IP69K	Yes + ALS Seal	

Non-metallic conduit systems

Type FL/45 & Swivel Coupler - Adaptalok



Type FL/45
45° Panel Mounting Swivel Flange

Type FL/45 - Adaptalok

45° Panel Mounting Swivel Flange / With integral face seal

Materials: Polyamide (Nylon) 66 / **Colour:** Black (BL), Grey (GR)

Part No.	Nominal Conduit Size
AL16/FL/45	16mm
AL21/FL/45	21mm
AL28/FL/45	28mm
AL54/FL/45	54mm

To order quote part number & body colour, e.g. AL16/FL/45/BL

Approvals



IP Rating

Appropriate Conduit

For use with: Type PA / PI / CP / PR / PF

IP66	Yes
IP67	Yes + ALS Seal
IP68	Yes + ALS Seal
IP69K	Yes + ALS Seal

Temperature Range

Static Applications: -50°C to +120°C

Moving Applications: -45°C to +120°C

Fitting Characteristics



Swivel Coupler
Straight PA66 Body Swivel Coupler

Swivel Coupler - Adaptalok

Straight PA66 Body Swivel Coupler / For coupling two corrugated flexible conduits

Materials: Polyamide (Nylon) 66 + Aluminium / **Colour:** Black (BL) Only

Part No.	Nominal Conduit Size
AL13/A/U/BL	13mm
AL16/A/U/BL	16mm
AL21/A/U/BL	21mm
AL28/A/U/BL	28mm
AL34/A/U/BL	34mm
AL42/A/U/BL	42mm
AL54/A/U/BL	54mm

To order quote part number, e.g. AL13/A/U/BL

Approvals



IP Rating

Appropriate Conduit

For use with: Type PA / PI / CP / PR / PF

IP66	Yes
IP67	Yes + ALS Seal
IP68	Yes + ALS Seal
IP69K	Yes + ALS Seal

Temperature Range

Static Applications: -50°C to +120°C

Moving Applications: -45°C to +120°C

Fitting Characteristics



Non-metallic conduit systems

Type SA & CS90 - Adapталок

2



Type SA
Straight Fitting

Type SA - Adapталок

Straight Fitting - Swivel External Male Thread / For insertion into threaded entries & knockouts using a locknut. Order locknut separately

Materials: Polyamide (Nylon) 66, Nickel Plated Brass Thread / **Colour:** Black (BL), Grey (GR)

Part No.	Nominal Conduit Size	Metric Thread	Part No.	Nominal Conduit Size	PG Thread
AL13/M16/SA	13mm	M16	AL13/PG9/SA	13mm	PG9
AL16/M16/SA	16mm	M16	AL16/PG11/SA	16mm	PG11
AL21/M20/SA	21mm	M20	AL21/PG13/SA	21mm	PG13,5
			AL21/PG16/SA	21mm	PG16
AL28/M25/SA	28mm	M25	AL28/PG21/SA	28mm	PG21
AL34/M32/SA	34mm	M32	AL34/PG29/SA	34mm	PG29
AL42/M40/SA	42mm	M40	AL42/PG36/SA	42mm	PG36
AL54/M50/SA	54mm	M50	AL54/PG48/SA	54mm	PG48
AL54/M63/SA	54mm	M63			

To order quote part number & body colour, e.g. AL13/M16/SA/BL
NPT also available

Approvals



IP Rating

Appropriate Conduit

For use with: Type PA / PI / CP / PR / PF

IP66	Yes
IP67	Yes + ALS Seal
IP68	Yes + ALS Seal
IP69K	Yes + ALS Seal

Temperature Range

Static Applications: -50°C to +120°C

Moving Applications: -45°C to +120°C

Fitting Characteristics



Type CS90
90° Elbow Fitting

Type CS90 - Adapталок

90° Elbow Fitting - Swivel External Male Thread / For insertion into threaded entries & knockouts using a locknut. Order locknut separately

Materials: Polyamide (Nylon) 66, Nickel Plated Brass Thread / **Colour:** Black (BL), Grey (GR)

Part No.	Nominal Conduit Size	Metric Thread	Part No.	Nominal Conduit Size	PG Thread
AL13/M16/CS90	13mm	M16	AL13/PG9/CS90	13mm	PG9
AL16/M16/CS90	16mm	M16	AL16/PG11/CS90	16mm	PG11
AL21/M20/CS90	21mm	M20	AL21/PG13/CS90	21mm	PG13,5
			AL21/PG16/CS90	21mm	PG16
AL28/M25/CS90	28mm	M25	AL28/PG21/CS90	28mm	PG21
AL34/M32/CS90	34mm	M32	AL34/PG29/CS90	34mm	PG29
AL42/M40/CS90	42mm	M40	AL42/PG36/CS90	42mm	PG36
AL54/M50/CS90	54mm	M50	AL54/PG48/CS90	54mm	PG48
AL54/M63/CS90	54mm	M63			

To order quote part number & body colour, e.g. AL13/M16/CS90/BL
NPT also available

Approvals



IP Rating

Appropriate Conduit

For use with: Type PA / PI / CP / PR / PF

IP66	Yes
IP67	Yes + ALS Seal
IP68	Yes + ALS Seal
IP69K	Yes + ALS Seal

Temperature Range

Static Applications: -50°C to +120°C

Moving Applications: -45°C to +120°C

Fitting Characteristics



Non-metallic conduit systems

Type S45 & SFA - Adaptalok



Type S45
45° Elbow Body

Type S45 - Adaptalok

45° Elbow Body - Swivel External Male Thread / For insertion into threaded entries & knockouts using a locknut. Order locknut separately

Materials: Polyamide (Nylon) 66, Nickel Plated Brass Thread / **Colour:** Black (BL), Grey (GR)

Part No.	Nominal Conduit Size	Metric Thread	Part No.	Nominal Conduit Size	PG Thread
AL13/M16/S45	13mm	M16	AL13/PG9/S45	13mm	PG9
AL16/M16/S45	16mm	M16	AL16/PG11/S45	16mm	PG11
AL21/M20/S45	21mm	M20	AL21/PG13/S45	21mm	PG13,5
			AL21/PG16/S45	21mm	PG16
AL28/M25/S45	28mm	M25	AL28/PG21/S45	28mm	PG21
AL34/M32/S45	34mm	M32	AL34/PG29/S45	34mm	PG29
AL42/M40/S45	42mm	M40	AL42/PG36/S45	42mm	PG36
AL54/M50/S45	54mm	M50	AL54/PG48/S45	54mm	PG48
AL54/M63/S45	54mm	M63			

To order quote part number & body colour, e.g. AL13/M16/S45/BL
NPT also available

Approvals



IP Rating	Appropriate Conduit	Temperature Range
For use with: Type PA / PI / CP / PR / PF		
IP66	Yes	Static Applications: -50°C to +120°C Moving Applications: -45°C to +120°C
IP67	Yes + ALS Seal	Fitting Characteristics
IP68	Yes + ALS Seal	
IP69K	Yes + ALS Seal	



Type SFA
Straight Body

Type SFA - Adaptalok

Straight Body - Swivel Internal Female Thread / For attaching to external threads & other fittings

Materials: Polyamide (Nylon) 66, Nickel Plated Brass Thread / **Colour:** Black (BL), Grey (GR)

Part No.	Nominal Conduit Size	Metric Thread	Part No.	Nominal Conduit Size	PG Thread
AL13/M16/SFA	13mm	M16	AL13/PG9/SFA	13mm	PG9
AL16/M16/SFA	16mm	M16	AL16/PG11/SFA	16mm	PG11
AL21/M20/SFA	21mm	M20	AL21/PG13/SFA	21mm	PG13,5
			AL21/PG16/SFA	21mm	PG16
AL28/M25/SFA	28mm	M25	AL28/PG21/SFA	28mm	PG21
AL34/M32/SFA	34mm	M32	AL34/PG29/SFA	34mm	PG29
AL42/M40/SFA	42mm	M40	AL42/PG36/SFA	42mm	PG36
AL54/M50/SFA	54mm	M50	AL54/PG48/SFA	54mm	PG48
AL54/M63/SFA	54mm	M63			

To order quote part number & body colour, e.g. AL13/M16/SFA/BL
NPT also available

Approvals



IP Rating	Appropriate Conduit	Temperature Range
For use with: Type PA / PI / CP / PR / PF		
IP66	Yes	Static Applications: -50°C to +120°C Moving Applications: -45°C to +120°C
IP67	Yes + ALS Seal	Fitting Characteristics
IP68	Yes + ALS Seal	
IP69K	Yes + ALS Seal	

Non-metallic conduit systems

Type CSF90 & SF45 - Adaptalok

2



Type CSF90
90° Elbow Fitting

Type CSF90 - Adaptalok

90° Elbow Fitting - Swivel Internal Female Thread / For attachment to external threads & other fittings

Materials: Polyamide (Nylon) 66, Nickel Plated Brass Thread / **Colour:** Black (BL), Grey (GR)

Part No.	Nominal Conduit Size	Metric Thread	Part No.	Nominal Conduit Size	PG Thread
AL13/M16/CSF90	13mm	M16	AL13/PG9/CSF90	13mm	PG9
AL16/M16/CSF90	16mm	M16	AL16/PG11/CSF90	16mm	PG11
AL21/M20/CSF90	21mm	M20	AL21/PG13/CSF90	16mm	PG13,5
			AL21/PG16/CSF90	21mm	PG16
AL28/M25/CSF90	28mm	M25	AL28/PG21/CSF90	28mm	PG21
AL34/M32/CSF90	34mm	M32	AL34/PG29/CSF90	34mm	PG29
AL42/M40/CSF90	42mm	M40	AL42/PG36/CSF90	42mm	PG36
AL54/M50/CSF90	54mm	M50	AL54/PG48/CSF90	54mm	PG48

To order quote part number & body colour, e.g. AL13/M16/CSF90/BL
NPT also available

Approvals



IP Rating

Appropriate Conduit

For use with: Type PA / PI / CP / PR / PF

IP66	Yes
IP67	Yes + ALS Seal
IP68	Yes + ALS Seal
IP69K	Yes + ALS Seal

Temperature Range

Static Applications: -50°C to +120°C

Moving Applications: -45°C to +120°C

Fitting Characteristics



Type SF45
45° Elbow Fitting

Type SF45 - Adaptalok

45° Elbow Fitting - Swivel Internal Female Thread / For attachment to external threads & other fittings

Materials: Polyamide (Nylon) 66, Nickel Plated Brass Thread / **Colour:** Black (BL), Grey (GR)

Part No.	Nominal Conduit Size	Metric Thread	Part No.	Nominal Conduit Size	PG Thread
AL13/M16/SF45	13mm	M16	AL13/PG9/SF45	13mm	PG9
AL16/M16/SF45	16mm	M16	AL16/PG11/SF45	16mm	PG11
AL21/M20/SF45	21mm	M20	AL21/PG13/SF45	16mm	PG13,5
			AL21/PG16/SF45	21mm	PG16
AL28/M25/SF45	28mm	M25	AL28/PG21/SF45	28mm	PG21
AL34/M32/SF45	34mm	M32	AL34/PG29/SF45	42mm	PG29
AL42/M40/SF45	40mm	M40	AL42/PG36/SF45	48mm	PG36
AL54/M50/SF45	50mm	M50	AL54/PG48/SF45	54mm	PG48
AL54/M63/SF45	63mm	M63			

To order quote part number & body colour, e.g. AL13/M16/SF90/BL
NPT also available

Approvals



IP Rating

Appropriate Conduit

For use with: Type PA / PI / CP / PR / PF

IP66	Yes
IP67	Yes + ALS Seal
IP68	Yes + ALS Seal
IP69K	Yes + ALS Seal

Temperature Range

Static Applications: -50°C to +120°C

Moving Applications: -45°C to +120°C

Fitting Characteristics



Non-metallic conduit systems

UNEF Type A



UNEF Type A
Straight Body

UNEF Type A - Adaptalok

Straight Body - Swivel Internal Female Thread / For coupling to UNEF circular connectors

Materials: Polyamide (Nylon) 66 & Aluminium / **Colour:** Black (BL) Only

Part No.	Nominal Conduit Size	Connector UNEF Thread	Part No.	Nominal Conduit Size	Connector UNEF Thread
AL13/U063/A	13mm	5/8" - 24	AL21/U144/A	21mm	1 7/16" - 18
AL13/U075/A	13mm	3/4" - 20	AL21/U175/A	21mm	1 3/4" - 18
AL13/U088/A	13mm	7/8" - 20	AL28/U088/A	28mm	7/8" - 20
AL16/U063/A	16mm	5/8" - 24	AL28/U094/A	28mm	15/16" - 20
AL16/U075/A	16mm	3/4" - 20	AL28/U100/A	28mm	1" - 20
AL16/U081/A	16mm	13/16" - 20	AL28/U119/A	28mm	1 3/16" - 18
AL16/U088/A	16mm	7/8" - 20	AL28/U138/A	28mm	1 3/8" - 18
AL16/U094/A	16mm	15/16" - 20	AL28/U144/A	28mm	1 7/16" - 18
AL16/U100/A	16mm	1" - 20	AL28/U175/A	28mm	1 3/4" - 18
AL16/U119/A	16mm	1 3/16" - 18	AL28/U200/A	28mm	2" - 16
AL16/U131/A	16mm	1 5/16" - 18	AL28/U225/A	28mm	2 1/4" - 16
AL21/U075/A	21mm	3/4" - 20	AL34/U100/A	34mm	1" - 20
AL21/U088/A	21mm	7/8" - 20	AL34/U119/A	34mm	1 3/16" - 18
AL21/U094/A	21mm	15/16" - 20	AL34/U144/A	34mm	1 7/16" - 18
AL21/U100/A	21mm	1" - 20	AL34/U175/A	34mm	1 3/4" - 18
AL21/U113/A	21mm	1 1/8" - 18	AL34/U200/A	34mm	2" - 16
AL21/U119/A	21mm	1 3/16" - 18	AL42/U175/A	42mm	1 3/4" - 18
AL21/U131/A	21mm	1 5/16" - 18	AL42/U200/A	42mm	2" - 16
AL21/U138/A	21mm	1 3/8" - 18			

To order quote part number, e.g. AL13/U063/A and add 000620

Approvals



IP Rating

Appropriate Conduit

For use with: Type PA / PI / CP / PR / PF

IP66	Yes
IP67	Yes + ALS Seal
IP68	Yes + ALS Seal
IP69K	Yes + ALS Seal

Temperature Range

Static Applications: -50°C to +120°C

Moving Applications: -45°C to +120°C

Fitting Characteristics



Non-metallic conduit systems

UNEF Type C90 - Adaptalok

2



UNEF Type C90
90° Elbow Body

UNEF Type C90 - Adaptalok

90° Elbow Body - Swivel Internal Female Thread / For coupling to UNEF circular connectors

Materials: Polyamide (Nylon) 66 & Aluminium / **Colour:** Black (BL) Only

Part No.	Nominal Conduit Size	Connector UNEF Thread	Part No.	Nominal Conduit Size	Connector UNEF Thread
AL13/U063/C90	13mm	5/8" - 24	AL21/U144/C90	21mm	1 7/16" - 18
AL13/U075/C90	13mm	3/4" - 20	AL21/U175/C90	21mm	1 3/4" - 18
AL13/U088/C90	13mm	7/8" - 20	AL28/U088/C90	28mm	7/8" - 20
AL16/U063/C90	16mm	5/8" - 24	AL28/U094/C90	28mm	15/16" - 20
AL16/U075/C90	16mm	3/4" - 20	AL28/U100/C90	28mm	1" - 20
AL16/U081/C90	16mm	13/16" - 20	AL28/U119/C90	28mm	1 3/16" - 18
AL16/U088/C90	16mm	7/8" - 20	AL28/U138/C90	28mm	1 3/8" - 18
AL16/U094/C90	16mm	15/16" - 20	AL28/U144/C90	28mm	1 7/16" - 18
AL16/U100/C90	16mm	1" - 20	AL28/U175/C90	28mm	1 3/4" - 18
AL16/U119/C90	16mm	1 3/16" - 18	AL28/U200/C90	28mm	2" - 16
AL16/U131/C90	16mm	1 5/16" - 18	AL28/U225/C90	28mm	2 1/4" - 16
AL21/U075/C90	21mm	3/4" - 20	AL34/U100/C90	34mm	1" - 20
AL21/U088/C90	21mm	7/8" - 20	AL34/U119/C90	34mm	1 3/16" - 18
AL21/U094/C90	21mm	15/16" - 20	AL34/U144/C90	34mm	1 7/16" - 18
AL21/U100/C90	21mm	1" - 20	AL34/U175/C90	34mm	1 3/4" - 18
AL21/U113/C90	21mm	1 1/8" - 18	AL34/U200/C90	34mm	2" - 16
AL21/U119/C90	21mm	1 3/16" - 18	AL42/U175/C90	42mm	1 3/4" - 18
AL21/U131/C90	21mm	1 5/16" - 18	AL42/U200/C90	42mm	2" - 16
AL21/U138/C90	21mm	1 3/8" - 18			

To order quote part number, e.g. AL13/U065/C90 and add 000620

Approvals



IP Rating

Appropriate Conduit

For use with: Type PA / PI / CP / PR / PF

IP66	Yes
IP67	Yes + ALS Seal
IP68	Yes + ALS Seal
IP69K	Yes + ALS Seal

Temperature Range

Static Applications: -50°C to +120°C

Moving Applications: -45°C to +120°C

Fitting Characteristics



Non-metallic conduit systems

UNEF Type 45 - Adaptalok



UNEF Type 45
45° Elbow Fitting

UNEF Type 45 - Adaptalok

45° Elbow Fitting - Swivel Internal Female Thread / For coupling to UNEF circular connectors

Materials: Polyamide (Nylon) 66 & Aluminium / Colour: Black (BL) Only

Part No.	Nominal Conduit Size	Connector UNEF Thread	Part No.	Nominal Conduit Size	Connector UNEF Thread
AL13/U063/45	13mm	5/8" - 24	AL21/U144/45	21mm	1 7/16" - 18
AL13/U075/45	13mm	3/4" - 20	AL21/U175/45	21mm	1 3/4" - 18
AL13/U088/45	13mm	7/8" - 20	AL28/U088/45	28mm	7/8" - 20
AL16/U063/45	16mm	5/8" - 24	AL28/U094/45	28mm	15/16" - 20
AL16/U075/45	16mm	3/4" - 20	AL28/U100/45	28mm	1" - 20
AL16/U081/45	16mm	13/16" - 20	AL28/U119/45	28mm	1 3/16" - 18
AL16/U088/45	16mm	7/8" - 20	AL28/U138/45	28mm	1 3/8" - 18
AL16/U094/45	16mm	15/16" - 20	AL28/U144/45	28mm	1 7/16" - 18
AL16/U100/45	16mm	1" - 20	AL28/U175/45	28mm	1 3/4" - 18
AL16/U119/45	16mm	1 3/16" - 18	AL28/U200/45	28mm	2" - 16
AL16/U131/45	16mm	1 5/16" - 18	AL28/U225/45	28mm	2 1/4" - 16
AL21/U075/45	21mm	3/4" - 20	AL34/U100/45	34mm	1" - 20
AL21/U088/45	21mm	7/8" - 20	AL34/U119/45	34mm	1 3/16" - 18
AL21/U094/45	21mm	15/16" - 20	AL34/U144/45	34mm	1 7/16" - 18
AL21/U100/45	21mm	1" - 20	AL34/U175/45	34mm	1 3/4" - 18
AL21/U113/45	21mm	1 1/8" - 18	AL34/U200/45	34mm	2" - 16
AL21/U119/45	21mm	1 3/16" - 18	AL42/U175/45	42mm	1 3/4" - 18
AL21/U131/45	21mm	1 5/16" - 18	AL42/U200/45	42mm	2" - 16
AL21/U138/45	21mm	1 3/8" - 18			

To order quote part number, e.g. AL13/U065/45 and add 000620

Approvals



IP Rating

Appropriate Conduit

For use with: Type PA / PI / CP / PR / PF

IP66	Yes
IP67	Yes + ALS Seal
IP68	Yes + ALS Seal
IP69K	Yes + ALS Seal

Temperature Range

Static Applications: -50°C to +120°C

Moving Applications: -45°C to +120°C

Fitting Characteristics



Non-metallic conduit systems

Jumbo Type FL/A - Adaptalok / Jumbo Type SK

2



Jumbo Type FL/A
Straight Panel Mounting
Swivel Flange

Approvals



Jumbo Type FL/A - Adaptalok Straight Panel Mounting Swivel Flange

Materials: Polyamide (Nylon) 66 / **Colour:** Black (BL) Only

Part No.	Nominal Conduit Size	
ADC80/FL/A	80mm	
ADC106/FL/A	106mm	

To order quote part number, e.g. ADC80/FL/A/BL

IP Rating	Appropriate Conduit	Temperature Range
For use with: Type PA / PI / PR 80/106		Static Applications: -50°C to +120°C
IP40	Yes	Moving Applications: -45°C to +120°C
IP65	Yes + SK Seal	
IP68	N/A	
IP69K	N/A	

Nominal Size	Part No.	
	ADC80/FL/A	ADC106/FL/A
A	60mm	74mm
B	80mm	108mm
C	98mm	126mm
D	52.5mm	52.5mm
E \varnothing	7mm	7mm
F	106mm	132mm

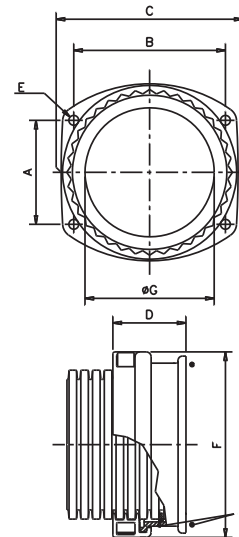

Seal (Optional)
for IP65



Jumbo Type SK
Sealing Kit

Jumbo Type SK

Sealing Kit / For use with Jumbo fittings to achieve IP65. Consists of two sealing washers & O-ring per kit

Materials: Rubber / **Colour:** Black (BL) Only

Part No.	Nominal Conduit Size	
SK80	80mm	
SK106	106mm	

To order quote part number, e.g. SK80/BL

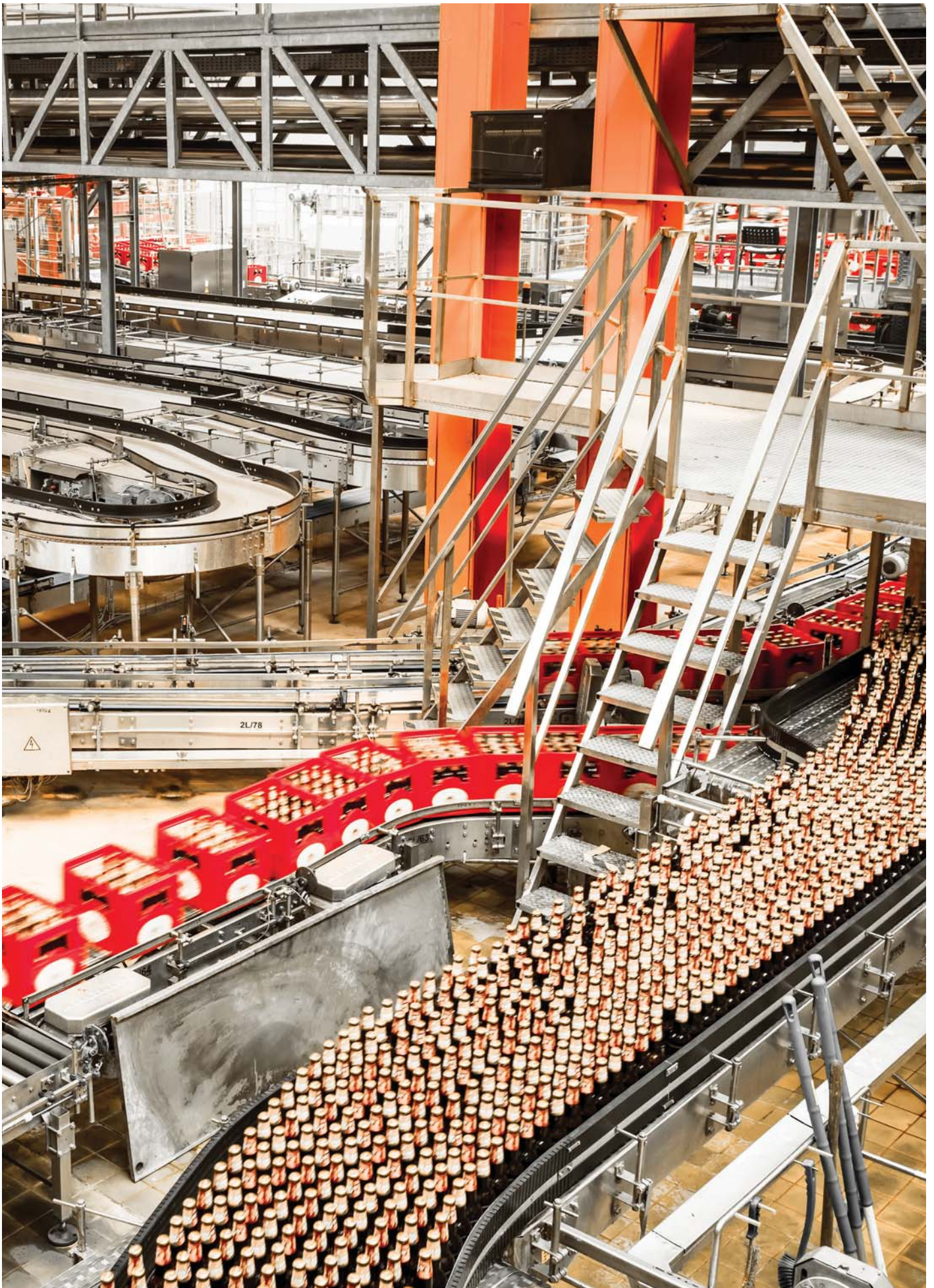

Non-metallic conduit systems

Introduction to Adaptalok ATS™

2

Adaptalok ATS™ represents a unique and innovative solution in flexible conduit systems. Until now, manufacturers have produced fittings and seals separately, and assembled them together, or had the customer assemble them. This increases assembly time and introduces the possibility for errors.

Adaptalok ATS™ uses a sophisticated moulding process to mould an internal conduit seal and a face seal washer. This makes installation times very fast, and extremely reliable, because the seals cannot be left out. The conduit system also benefits from the highest IP rating possible.

Additional key features:

- Nylon 66 Body
- Lighter in weight
- Quicker to install (cut & assemble fittings)
- Wider variety of fittings - much larger solutions choice
- Better fatigue life
- Return to shape



Non-metallic conduit systems

Type A - Adaptalok ATS™



Type A
Straight Fitting

Approvals



Type A
Straight Fitting

Approvals



Type A - Adaptalok ATS™

Straight Fitting - Fixed External Male Thread / For insertion into knockouts using a locknut. Locknut supplied with METRIC thread

Materials: Polyamide (Nylon) 66/TPE / **Colour:** Black (BL), Grey (GR) / Yellow (Y) Elastomer

Part No.	Nominal Conduit Size	Metric Thread	Part No.	Nominal Conduit Size	PF Thread	Part No.	Nominal Conduit Size	NPT Thread
AT13/M16/A	13mm	M16	AT13/PF038/A	13mm	3/8"	AT13/038/A	13mm	3/8"
AT16/M16/A	16mm	M16	AT16/PF038/A	16mm	3/8"	AT16/038/A	16mm	3/8"
AT16/M20/A	16mm	M20	AT16/PF050/A	16mm	1/2"	AT16/050/A	16mm	1/2"
AT21/M20/A	21mm	M20	AT21/PF050/A	21mm	1/2"	AT21/050/A	21mm	1/2"
AT21/M25/A	21mm	M25						
AT28/M25/A	28mm	M25	AT28/PF075/A	28mm	3/4"	AT28/075/A	28mm	3/4"
AT28/M32/A	28mm	M32						
AT34/M32/A	34mm	M32	AT34/PF100/A	34mm	1"	AT34/100/A	34mm	1"
AT34/M40/A	34mm	M40						
AT42/M40/A	42mm	M40	AT42/PF125/A	42mm	1 1/4"	AT42/125/A	42mm	1 1/4"
AT42/M50/A	42mm	M50						
AT48/M50/A	48mm	M50	AT48/PF150/A	48mm	1 1/2"	AT48/150/A	48mm	1 1/2"
AT54/M50/A	54mm	M50						
AT54/M63/A	54mm	M63	AT54/PF200/A	48mm	2"	AT54/200/A	54mm	2"

To order quote part number, body colour & Elastomer colour, e.g. AT21/M20/A/BLY

Type A - Adaptalok ATS™

Straight Fitting - Fixed External Male Thread / For insertion into knockouts using a locknut. Locknut supplied with METRIC thread

Materials: Polyamide (Nylon) 66/TPE / **Colour:** Black (BL), Grey (GR) / Blue (B) Elastomer

Part No.	Nominal Conduit Size	Metric Thread	Part No.	Nominal Conduit Size	NPT Thread
AT13/M16/A	13mm	M16	AT13/038/A	13mm	3/8"
AT16/M16/A	16mm	M16	AT16/038/A	16mm	3/8"
AT16/M20/A	16mm	M20	AT16/050/A	16mm	1/2"
AT21/M20/A	21mm	M20	AT21/050/A	21mm	1/2"
AT21/M25/A	21mm	M25			
AT28/M25/A	28mm	M25	AT28/075/A	28mm	3/4"
AT28/M32/A	28mm	M32			
AT34/M32/A	34mm	M32	AT34/100/A	34mm	1"
AT34/M40/A	34mm	M40			
AT42/M40/A	42mm	M40	AT42/125/A	42mm	1 1/4"
AT42/M50/A	42mm	M50			
AT48/M50/A	48mm	M50	AT48/150/A	48mm	1 1/2"
AT54/M50/A	54mm	M50			
AT54/M63/A	54mm	M63	AT54/200/A	54mm	2"

To order quote part number, body colour & Elastomer colour, e.g. AT21/M20/A/BLB

IP Rating	Appropriate Conduit	Temperature Range
For use with: Type PA / PI / PR / PADL / PF		Static Applications: -50°C to +120°C
IP40	Yes	Moving Applications: -45°C to +120°C
IP65	Yes	
IP68	Yes (4 bar 30mins)	
IP69K	Yes	

Non-metallic conduit systems

Type C90 - Adaptalok ATS™

2



Type C90
90° Elbow Fitting

Type C90 - Adaptalok ATS™

90° Elbow Fitting - Fixed External Male Thread / For insertion into knockouts using a locknut. Locknut supplied with METRIC thread

Materials: Polyamide (Nylon) 66/TPE / Colour: Black (BL), Grey (GR) / Yellow (Y) Elastomer

Part No.	Nominal Conduit Size	Metric Thread	Part No.	Nominal Conduit Size	PF Thread	Part No.	Nominal Conduit Size	NPT Thread
AT13/M16/C90	13mm	M16	AT13/PF038/C90	13mm	3/8"	AT13/038/C90	13mm	3/8"
AT16/M16/C90	16mm	M16	AT16/PF038/C90	16mm	3/8"	AT16/038/C90	16mm	3/8"
AT16/M20/C90	16mm	M20	AT16/PF050/C90	16mm	1/2"	AT16/050/C90	16mm	1/2"
AT21/M20/C90	21mm	M20	AT21/PF050/C90	21mm	1/2"	AT21/050/C90	21mm	1/2"
AT28/M25/C90	28mm	M25	AT28/PF075/C90	28mm	3/4"	AT28/075/C90	28mm	3/4"
AT34/M32/C90	34mm	M32	AT34/PF100/C90	34mm	1"	AT34/100/C90	34mm	1"
AT42/M40/C90	42mm	M40	AT42/PF125/C90	42mm	1 1/4"	AT42/125/C90	42mm	1 1/4"
AT48/M50/C90	48mm	M50	AT48/PF150/C90	48mm	1 1/2"	AT48/150/C90	48mm	1 1/2"
AT54/M50/C90	54mm	M50	AT54/PF150/C90	54mm	1 1/2"	AT54/150/C90	54mm	1 1/2"
AT54/M63/C90	54mm	M63	AT54/PF200/C90	54mm	2"	AT54/200/C90	54mm	2"

To order quote part number, body colour & Elastomer colour, e.g. AT21/M20/C90/BLY

Approvals



IP Rating

Appropriate Conduit

For use with: Type PA / PI / PR / PADL / PF

IP40	Yes
IP65	Yes
IP68	Yes (4 bar 30mins)
IP69K	Yes

Temperature Range

Static Applications: -50°C to +120°C

Moving Applications: -45°C to +120°C



Type C90
90° Elbow Fitting

Type C90 - Adaptalok ATS™

90° Elbow Fitting - Fixed External Male Thread / For insertion into knockouts using a locknut. Locknut supplied with METRIC thread

Materials: Polyamide (Nylon) 66/TPE / Colour: Black (BL), Grey (GR) / Blue (B) Elastomer

Part No.	Nominal Conduit Size	Metric Thread	Part No.	Nominal Conduit Size	PF Thread
AT13/M16/C90	13mm	M16	AT13/PF038/C90	13mm	3/8"
AT16/M16/C90	16mm	M16	AT16/PF038/C90	16mm	3/8"
AT16/M20/C90	16mm	M20	AT16/PF050/C90	16mm	1/2"
AT21/M20/C90	21mm	M20	AT21/PF050/C90	21mm	1/2"
AT28/M25/C90	28mm	M25	AT28/PF075/C90	28mm	3/4"
AT34/M32/C90	34mm	M32	AT34/PF100/C90	34mm	1"
AT42/M40/C90	42mm	M40	AT42/PF125/C90	42mm	1 1/4"
AT48/M50/C90	48mm	M50	AT48/PF150/C90	48mm	1 1/2"
AT54/M50/C90	54mm	M50	AT54/PF150/C90	54mm	1 1/2"
AT54/M63/C90	54mm	M63	AT54/PF200/C90	54mm	2"

To order quote part number, body colour & Elastomer colour, e.g. AT21/M20/C90/BLB

Approvals



IP Rating

Appropriate Conduit

For use with: Type PA / PI / PR / PADL / PF

IP40	Yes
IP65	Yes
IP68	Yes (4 bar 30mins)
IP69K	Yes

Temperature Range

Static Applications: -50°C to +120°C

Moving Applications: -45°C to +120°C

Non-metallic conduit systems

Type 45 - Adaptalok ATS™



Type 45
45° Elbow Fitting

Type 45 - Adaptalok ATS™

45° Elbow Fitting - Fixed External Male Thread / For insertion into knockouts using a locknut. Locknut supplied with METRIC thread

Materials: Polyamide (Nylon) 66/TPE / Colour: Black (BL), Grey (GR) / Yellow (Y) Elastomer

Part No.	Nominal Conduit Size	Metric Thread	Part No.	Nominal Conduit Size	PF Thread	Part No.	Nominal Conduit Size	NPT Thread
AT13/M16/45	13mm	M16	AT13/PF038/45	13mm	3/8"	AT13/038/45	13mm	3/8"
AT16/M16/45	16mm	M16	AT16/PF038/45	16mm	3/8"	AT16/038/45	16mm	3/8"
AT16/M20/45	16mm	M20	AT16/PF050/45	16mm	1/2"	AT16/050/45	16mm	1/2"
AT21/M20/45	21mm	M20	AT21/PF050/45	21mm	1/2"	AT21/050/45	21mm	1/2"
AT28/M25/45	28mm	M25	AT28/PF075/45	28mm	3/4"	AT28/075/45	28mm	3/4"
AT34/M32/45	34mm	M32	AT34/PF100/45	34mm	1"	AT34/100/45	34mm	1"
AT42/M40/45	42mm	M40	AT42/PF125/45	42mm	1 1/4"	AT42/125/45	42mm	1 1/4"
AT48/M50/45	48mm	M50	AT48/PF150/45	48mm	1 1/2"	AT48/150/45	48mm	1 1/2"
AT54/M50/45	54mm	M50						

To order quote part number, body colour & Elastomer colour, e.g. AT54/M50/45/BLY

Approvals



NF U

IP Rating	Appropriate Conduit	Temperature Range
For use with: Type PA / PI / PR / PADL / PF		
IP40	Yes	Static Applications: -50°C to +120°C
IP65	Yes	Moving Applications: -45°C to +120°C
IP68	Yes (4 bar 30mins)	
IP69K	Yes	



Type 45
45° Elbow Fitting

Type 45 - Adaptalok ATS™

45° Elbow Fitting - Fixed External Male Thread / For insertion into knockouts using a locknut. Locknut supplied with METRIC thread

Materials: Polyamide (Nylon) 66/TPE / Colour: Black (BL), Grey (GR) / Blue (B) Elastomer

Part No.	Nominal Conduit Size	Metric Thread	Part No.	Nominal Conduit Size	PF Thread
AT13/M16/45	13mm	M16	AT13/PF038/45	13mm	3/8"
AT16/M16/45	16mm	M16	AT16/PF038/45	16mm	3/8"
AT16/M20/45	16mm	M20	AT16/PF050/45	16mm	1/2"
AT21/M20/45	21mm	M20	AT21/PF050/45	21mm	1/2"
AT28/M25/45	28mm	M25	AT28/PF075/45	28mm	3/4"
AT34/M32/45	34mm	M32	AT34/PF100/45	34mm	1"
AT42/M40/45	42mm	M40	AT42/PF125/45	42mm	1 1/4"
AT48/M50/45	48mm	M50	AT48/PF150/45	48mm	1 1/2"
AT54/M50/45	54mm	M50			

To order quote part number, body colour & Elastomer colour, e.g. AT54/M50/45/BLB

Approvals



NF U cRU US

IP Rating	Appropriate Conduit	Temperature Range
For use with: Type PA / PI / PR / PADL / PF		
IP40	Yes	Static Applications: -50°C to +120°C
IP65	Yes	Moving Applications: -45°C to +120°C
IP68	Yes (4 bar 30mins)	
IP69K	Yes	

Non-metallic conduit systems

Type SA & CS90 - Adaptalok ATS™

2



Type SA
Straight Fitting

Type SA - Adaptalok ATS™

Straight Fitting - Metal Swivel External Male Thread / For insertion into threaded entries & knockouts. Order locknuts separately

Materials: Polyamide (Nylon) 66, Nickel Plated Brass Thread/TPE

Colour: Black (BL), Grey (GR) / Yellow (Y), Blue (B) Elastomer

Part No.	Nominal Conduit Size	Metric Thread	Part No.	Nominal Conduit Size	NPT Thread
AT13/M16/SA	13mm	M16	AT13/038/SA	13mm	3/8"
AT16/M16/SA	16mm	M16	AT16/038/SA	16mm	3/8"
AT21/M20/SA	21mm	M20	AT21/050/SA	21mm	1/2"
AT28/M25/SA	28mm	M25	AT28/075/SA	28mm	3/4"
AT34/M32/SA	34mm	M32	AT34/100/SA	34mm	1"
AT42/M40/SA	42mm	M40	AT42/125/SA	42mm	1 1/4"
AT48/M50/SA	48mm	M50	AT48/150/SA	48mm	1 1/2"
AT54/M50/SA	54mm	M50	AT54/150/SA	54mm	1 1/2"
AT54/M63/SA	54mm	M63	AT54/200/SA	54mm	2"

To order quote part number, body colour & Elastomer colour, e.g. AT16/M16/SA/BLB

Approvals

Blue Elastomer
Version Only



IP Rating

Appropriate Conduit

For use with: Type PA / PI / PR / PADL / PF

IP40	Yes
IP65	Yes
IP68	Yes (4 bar 30mins)
IP69K	Yes

Temperature Range

Static Applications: -50°C to +120°C

Moving Applications: -45°C to +120°C

Fitting Characteristics



Type CS90
90° Elbow Fitting

Type CS90 - Adaptalok ATS™

90° Elbow Fitting - Swivel External Male Thread / For insertion into threaded entries & knockouts. Order locknuts separately

Materials: Polyamide (Nylon) 66, Nickel Plated Brass Thread/TPE

Colour: Black (BL), Grey (GR) / Yellow (Y), Blue (B) Elastomer

Part No.	Nominal Conduit Size	Metric Thread	Part No.	Nominal Conduit Size	NPT Thread
AT13/M16/CS90	13mm	M16	AT13/038/CS90	13mm	3/8"
AT16/M16/CS90	16mm	M16	AT16/038/CS90	16mm	3/8"
AT21/M20/CS90	21mm	M20	AT21/050/CS90	21mm	1/2"
AT28/M25/CS90	28mm	M25	AT28/075/CS90	28mm	3/4"
AT34/M32/CS90	34mm	M32	AT34/100/CS90	34mm	1"
AT42/M40/CS90	42mm	M40	AT42/125/CS90	42mm	1 1/4"
AT48/M50/CS90	48mm	M50	AT48/150/CS90	48mm	1 1/2"
AT54/M50/CS90	54mm	M50	AT54/150/CS90	54mm	1 1/2"
AT54/M63/CS90	54mm	M63	AT54/200/CS90	54mm	2"

To order quote part number, body colour & Elastomer colour, e.g. AT16/M16/CS90/BLB

Approvals

Blue Elastomer
Version Only



IP Rating

Appropriate Conduit

For use with: Type PA / PI / PR / PADL / PF

IP40	Yes
IP65	Yes
IP68	Yes (4 bar 30mins)
IP69K	Yes

Temperature Range

Static Applications: -50°C to +120°C

Moving Applications: -45°C to +120°C

Fitting Characteristics



Non-metallic conduit systems

Type S45 & SFA - Adaptalok ATS™



Type S45
45° Elbow Body

Type S45 - Adaptalok ATS™

45° Elbow Body - Swivel External Male Thread / For insertion into threaded entries & knockouts. Order locknuts separately

Materials: Polyamide (Nylon) 66, Nickel Plated Brass Thread/TPE

Colour: Black (BL), Grey (GR) / Yellow (Y), Blue (B) Elastomer

Part No.	Nominal Conduit Size	Metric Thread	Part No.	Nominal Conduit Size	NPT Thread
AT13/M16/S45	13mm	M16	AT13/038/S45	13mm	3/8"
AT16/M16/S45	16mm	M16	AT16/038/S45	16mm	3/8"
AT21/M20/S45	21mm	M20	AT21/050/S45	21mm	1/2"
AT28/M25/S45	28mm	M25	AT28/075/S45	28mm	3/4"
AT34/M32/S45	34mm	M32	AT34/100/S45	34mm	1"
AT42/M40/S45	42mm	M40	AT42/125/S45	42mm	1 1/4"
AT48/M50/S45	48mm	M50	AT48/150/S45	48mm	1 1/2"
AT54/M50/S45	54mm	M50	AT54/150/S45	54mm	1 1/2"
AT54/M63/S45	54mm	M63	AT54/200/S45	54mm	2"

To order quote part number, body colour & Elastomer colour, e.g. AT54/M63/S45/BLB

Approvals

Blue Elastomer
Version Only



IP Rating

Appropriate Conduit

For use with: Type PA / PI / PR / PADL / PF

IP40	Yes
IP65	Yes
IP68	Yes (4 bar 30mins)
IP69K	Yes

Temperature Range

Static Applications: -50°C to +120°C

Moving Applications: -45°C to +120°C

Fitting Characteristics



Type SFA
Straight Fitting

Type SFA - Adaptalok ATS™

Straight Fitting - Swivel Internal Female Thread / For attachments to external threads & other fittings

Materials: Polyamide (Nylon) 66, Nickel Plated Brass Thread/TPE

Colour: Black (BL), Grey (GR) / Yellow (Y), Blue (B) Elastomer

Part No.	Nominal Conduit Size	Metric Thread	Part No.	Nominal Conduit Size	NPT Thread
AT13/M16/SFA	13mm	M16	AT13/038/SFA	13mm	3/8"
AT16/M16/SFA	16mm	M16	AT16/038/SFA	16mm	3/8"
AT21/M20/SFA	21mm	M20	AT21/050/SFA	21mm	1/2"
AT28/M25/SFA	28mm	M25	AT28/075/SFA	28mm	3/4"
AT34/M32/SFA	34mm	M32	AT34/100/SFA	34mm	1"
AT42/M40/SFA	42mm	M40	AT42/125/SFA	42mm	1 1/4"
AT48/M50/SFA	48mm	M50	AT48/150/SFA	48mm	1 1/2"
AT54/M50/SFA	54mm	M50			
AT54/M63/SFA	54mm	M63	AT54/200/SFA	54mm	2"

To order quote part number, body colour & Elastomer colour, e.g. AT54/M63/SFA/BLB

Approvals

Blue Elastomer
Version Only



IP Rating

Appropriate Conduit

For use with: Type PA / PI / PR / PADL / PF

IP40	Yes
IP65	Yes
IP68	Yes (4 bar 30mins)
IP69K	Yes

Temperature Range

Static Applications: -50°C to +120°C

Moving Applications: -45°C to +120°C

Fitting Characteristics



Non-metallic conduit systems

Type CSF90 & SF45 - Adaptalok ATS™

2



Type CSF90
90° Elbow Body

Type CSF90 - Adaptalok ATS™

90° Elbow Body - Swivel Internal Female Thread / For attaching to external threads & other fittings

Materials: Polyamide (Nylon) 66, Nickel Plated Brass Thread/TPE

Colour: Black (BL), Grey (GR) / Yellow (Y), Blue (B) Elastomer

Part No.	Nominal Conduit Size	Metric Thread	Part No.	Nominal Conduit Size	NPT Thread
AT13/M16/CSF90	13mm	M16	AT13/038/CSF90	13mm	3/8"
AT16/M16/CSF90	16mm	M16	AT16/038/CSF90	16mm	3/8"
AT21/M20/CSF90	21mm	M20	AT21/050/CSF90	21mm	1/2"
AT28/M25/CSF90	28mm	M25	AT28/075/CSF90	28mm	3/4"
AT34/M32/CSF90	34mm	M32	AT34/100/CSF90	34mm	1"
AT42/M40/CSF90	42mm	M40	AT42/125/CSF90	42mm	1 1/4"
AT48/M50/CSF90	48mm	M50	AT48/150/CSF90	48mm	1 1/2"
AT54/M50/CSF90	54mm	M50			
AT54/M63/CSF90	54mm	M63	AT54/200/CSF90	54mm	2"

To order quote part number, body colour & Elastomer colour, e.g. AT16/M16/CSF90/BLB

Approvals

Blue Elastomer
Version Only



IP Rating

Appropriate Conduit

For use with: Type PA / PI / PR / PADL / PF

IP40	Yes
IP65	Yes
IP68	Yes (4 bar 30mins)
IP69K	Yes

Temperature Range

Static Applications: -50°C to +120°C

Moving Applications: -45°C to +120°C

Fitting Characteristics



Type SF45
45° Elbow Body

Type SF45 - Adaptalok ATS™

45° Elbow Body - Swivel Internal Female Thread / For attaching to external threads & other fittings

Materials: Polyamide (Nylon) 66, Nickel Plated Brass Thread/TPE

Colour: Black (BL), Grey (GR) / Yellow (Y), Blue (B) Elastomer

Part No.	Nominal Conduit Size	Metric Thread	Part No.	Nominal Conduit Size	NPT Thread
AT13/M16/SF45	13mm	M16	AT13/038/SF45	13mm	3/8"
AT16/M16/SF45	16mm	M16	AT16/038/SF45	16mm	3/8"
AT21/M20/SF45	21mm	M20	AT21/050/SF45	21mm	1/2"
AT28/M25/SF45	28mm	M25	AT28/075/SF45	28mm	3/4"
AT34/M32/SF45	34mm	M32	AT34/100/SF45	34mm	1"
AT42/M40/SF45	42mm	M40	AT42/125/SF45	42mm	1 1/4"
AT48/M50/SF45	48mm	M50	AT48/150/SF45	48mm	1 1/2"
AT54/M50/SF45	54mm	M50			
AT54/M63/SF45	54mm	M63	AT54/200/SF45	54mm	2"

To order quote part number, body colour & Elastomer colour, e.g. AT16/M16/SF45/BLB

Approvals

Blue Elastomer
Version Only



IP Rating

Appropriate Conduit

For use with: Type PA / PI / PR / PADL / PF

IP40	Yes
IP65	Yes
IP68	Yes (4 bar 30mins)
IP69K	Yes

Temperature Range

Static Applications: -50°C to +120°C

Moving Applications: -45°C to +120°C

Fitting Characteristics



Non-metallic conduit systems

UNEF Type SFA - Adaptalok ATS™



UNEF Type SFA
Straight Body

UNEF Type SFA - Adaptalok ATS™

Straight Body - Swivel Internal Female Thread / For coupling to UNEF circular connectors

Materials: Polyamide (Nylon) 66, Aluminium/TPE / **Colour:** Black (BL) Only / Yellow (Y), Blue (B) Elastomer

Part No.	Nominal Conduit Size	Connector UNEF Thread	Part No.	Nominal Conduit Size	Connector UNEF Thread
AT13/U063/SFA	13mm	5/8" - 24	AT21/U144/SFA	21mm	1 7/16" - 18
AT13/U075/SFA	13mm	3/4" - 20	AT21/U175/SFA	21mm	1 3/4" - 18
AT13/U088/SFA	13mm	7/8" - 20	AT28/U088/SFA	28mm	7/8" - 20
AT16/U063/SFA	16mm	5/8" - 24	AT28/U094/SFA	28mm	15/16" - 20
AT16/U075/SFA	16mm	3/4" - 20	AT28/U100/SFA	28mm	1" - 20
AT16/U081/SFA	16mm	13/16" - 20	AT28/U119/SFA	28mm	1 3/16" - 18
AT16/U088/SFA	16mm	7/8" - 20	AT28/U138/SFA	28mm	1 3/8" - 18
AT16/U094/SFA	16mm	15/16" - 20	AT28/U144/SFA	28mm	1 7/16" - 18
AT16/U100/SFA	16mm	1" - 20	AT28/U175/SFA	28mm	1 3/4" - 18
AT16/U119/SFA	16mm	1 3/16" - 18	AT28/U200/SFA	28mm	2" - 16
AT16/U131/SFA	16mm	1 5/16" - 18	AT28/U225/SFA	28mm	2 1/4" - 16
AT21/U075/SFA	21mm	3/4" - 20	AT34/U100/SFA	34mm	1" - 20
AT21/U088/SFA	21mm	7/8" - 20	AT34/U119/SFA	34mm	1 3/16" - 18
AT21/U094/SFA	21mm	15/16" - 20	AT34/U144/SFA	34mm	1 7/16" - 18
AT21/U100/SFA	21mm	1" - 20	AT34/U175/SFA	34mm	1 3/4" - 18
AT21/U113/SFA	21mm	1 1/8" - 18	AT34/U200/SFA	34mm	2" - 16
AT21/U119/SFA	21mm	1 3/16" - 18	AT42/U175/SFA	42mm	1 3/4" - 18
AT21/U131/SFA	21mm	1 5/16" - 18	AT42/U200/SFA	42mm	2" - 16
AT21/U138/SFA	21mm	1 3/8" - 18			

To order quote part number, body colour & Elastomer colour, e.g. AT16/U063/SFA/BLB

Approvals



Blue Elastomer Version Only



IP Rating

For use with: Type PA / PI / PR / PADL / PF

IP Rating	Appropriate Conduit
IP40	Yes
IP65	Yes
IP68	Yes (4 bar 30mins)
IP69K	Yes

Temperature Range

Static Applications: -50°C to +120°C

Moving Applications: -45°C to +120°C

Fitting Characteristics



Non-metallic conduit systems

UNEF Type CSF90 - Adaptalok ATS™

2



UNEF Type CSF90
90° Elbow Body

UNEF Type CSF90 - Adaptalok ATS™

90° Elbow Body - Swivel Internal Female Thread / For coupling to UNEF circular connectors

Materials: Polyamide (Nylon) 66, Aluminium/TPE / **Colour:** Black (BL) Only / Yellow (Y), Blue (B) Elastomer

Part No.	Nominal Conduit Size	Connector UNEF Thread	Part No.	Nominal Conduit Size	Connector UNEF Thread
AT13/U063/CSF90	13mm	5/8" - 24	AT21/U144/CSF90	21mm	1 7/16" - 18
AT13/U075/CSF90	13mm	3/4" - 20	AT21/U175/CSF90	21mm	1 3/4" - 18
AT13/U088/CSF90	13mm	7/8" - 20	AT28/U088/CSF90	28mm	7/8" - 20
AT16/U063/CSF90	16mm	5/8" - 24	AT28/U094/CSF90	28mm	15/16" - 20
AT16/U075/CSF90	16mm	3/4" - 20	AT28/U100/CSF90	28mm	1" - 20
AT16/U081/CSF90	16mm	13/16" - 20	AT28/U119/CSF90	28mm	1 3/16" - 18
AT16/U088/CSF90	16mm	7/8" - 20	AT28/U138/CSF90	28mm	1 3/8" - 18
AT16/U094/CSF90	16mm	15/16" - 20	AT28/U144/CSF90	28mm	1 7/16" - 18
AT16/U100/CSF90	16mm	1" - 20	AT28/U175/CSF90	28mm	1 3/4" - 18
AT16/U119/CSF90	16mm	1 3/16" - 18	AT28/U200/CSF90	28mm	2" - 16
AT16/U131/CSF90	16mm	1 5/16" - 18	AT28/U225/CSF90	28mm	2 1/4" - 16
AT21/U075/CSF90	21mm	3/4" - 20	AT34/U100/CSF90	34mm	1" - 20
AT21/U088/CSF90	21mm	7/8" - 20	AT34/U119/CSF90	34mm	1 3/16" - 18
AT21/U094/CSF90	21mm	15/16" - 20	AT34/U144/CSF90	34mm	1 7/16" - 18
AT21/U100/CSF90	21mm	1" - 20	AT34/U175/CSF90	34mm	1 3/4" - 18
AT21/U113/CSF90	21mm	1 1/8" - 18	AT34/U200/CSF90	34mm	2" - 16
AT21/U119/CSF90	21mm	1 3/16" - 18	AT42/U175/CSF90	42mm	1 3/4" - 18
AT21/U131/CSF90	21mm	1 5/16" - 18	AT42/U200/CSF90	42mm	2" - 16
AT21/U138/CSF90	21mm	1 3/8" - 18			

To order quote part number, body colour & Elastomer colour, e.g. AT16/U063/CSF90/BLB

Approvals



Blue Elastomer Version Only



IP Rating

For use with: Type PA / PI / PR / PADL / PF

IP Rating	Appropriate Conduit
IP40	Yes
IP65	Yes
IP68	Yes (4 bar 30mins)
IP69K	Yes

Temperature Range

Static Applications: -50°C to +120°C

Moving Applications: -45°C to +120°C

Fitting Characteristics



Non-metallic conduit systems

UNEF Type SF45 - Adaptalok ATS™



UNEF Type SF45
45° Elbow Body

UNEF Type SF45 - Adaptalok ATS™

45° Elbow Body - Swivel Internal Female Thread / For coupling to UNEF circular connectors

Materials: Polyamide (Nylon) 66, Aluminium/TPE / **Colour:** Black (BL) Only / Yellow (Y), Blue (B) Elastomer

Part No.	Nominal Conduit Size	Connector UNEF Thread	Part No.	Nominal Conduit Size	Connector UNEF Thread
AT13/U063/SF45	13mm	5/8" - 24	AT21/U144/SF45	21mm	1 7/16" - 18
AT13/U075/SF45	13mm	3/4" - 20	AT21/U175/SF45	21mm	1 3/4" - 18
AT13/U088/SF45	13mm	7/8" - 20	AT28/U088/SF45	28mm	7/8" - 20
AT16/U063/SF45	16mm	5/8" - 24	AT28/U094/SF45	28mm	15/16" - 20
AT16/U075/SF45	16mm	3/4" - 20	AT28/U100/SF45	28mm	1" - 20
AT16/U081/SF45	16mm	13/16" - 20	AT28/U119/SF45	28mm	1 3/16" - 18
AT16/U088/SF45	16mm	7/8" - 20	AT28/U138/SF45	28mm	1 3/8" - 18
AT16/U094/SF45	16mm	15/16" - 20	AT28/U144/SF45	28mm	1 7/16" - 18
AT16/U100/SF45	16mm	1" - 20	AT28/U175/SF45	28mm	1 3/4" - 18
AT16/U119/SF45	16mm	1 3/16" - 18	AT28/U200/SF45	28mm	2" - 16
AT16/U131/SF45	16mm	1 5/16" - 18	AT28/U225/SF45	28mm	2 1/4" - 16
AT21/U075/SF45	21mm	3/4" - 20	AT34/U100/SF45	34mm	1" - 20
AT21/U088/SF45	21mm	7/8" - 20	AT34/U119/SF45	34mm	1 3/16" - 18
AT21/U094/SF45	21mm	15/16" - 20	AT34/U144/SF45	34mm	1 7/16" - 18
AT21/U100/SF45	21mm	1" - 20	AT34/U175/SF45	34mm	1 3/4" - 18
AT21/U113/SF45	21mm	1 1/8" - 18	AT34/U200/SF45	34mm	2" - 16
AT21/U119/SF45	21mm	1 3/16" - 18	AT42/U175/SF45	42mm	1 3/4" - 18
AT21/U131/SF45	21mm	1 5/16" - 18	AT42/U200/SF45	42mm	2" - 16
AT21/U138/SF45	21mm	1 3/8" - 18			

To order quote part number, body colour & Elastomer colour, e.g. AT16/U063/SF45/BLB

Approvals



NF Uⁱ

Blue Elastomer
Version Only



ETL US
Intertek
C^{UL} US

IP Rating

For use with: Type PA / PI / PR / PADL / PF

IP Rating	Appropriate Conduit
IP40	Yes
IP65	Yes
IP68	Yes (4 bar 30mins)
IP69K	Yes

Temperature Range

Static Applications: -50°C to +120°C

Moving Applications: -45°C to +120°C

Fitting Characteristics



Non-metallic conduit systems

Swivel Coupler & Panel Mounting Type FL/A - Adaptalok ATS™

2



Swivel Coupler
Straight PA66 Body

Swivel Coupler - Adaptalok ATS™

Straight PA66 Body - Swivel Coupler / For coupling to corrugated flexible conduit

Materials: Polyamide (Nylon) 66/TPE / **Colour:** Black (BL) Only / Yellow (Y), Blue (B) Elastomer

Part No.	Nominal Conduit Size
AT13/A/U	13mm
AT16/A/U	16mm
AT21/A/U	21mm
AT28/A/U	28mm
AT34/A/U	34mm
AT42/A/U	42mm
AT48/A/U	48mm
AT54/A/U	54mm

To order quote part number, body colour & Elastomer colour, e.g. AT21/A/U/BLB

Approvals

Blue Elastomer
Version Only



IP Rating

Appropriate Conduit

For use with: Type PA / PI / PR / PADL / PF

IP40	Yes
IP65	Yes
IP68	Yes (4 bar 30mins)
IP69K	Yes

Temperature Range

Static Applications: -50°C to +120°C

Moving Applications: -45°C to +120°C

Fitting Characteristics



Panel Mounting Type FL/A
Straight Panel Mounting
Swivel Flange

Panel Mounting Type FL/A - Adaptalok ATS™

Straight Panel Mounting-Swivel Flange / With integral face seal

Materials: Polyamide (Nylon) 66/TPE / **Colour:** Black (BL), Grey (GR) / Yellow (Y), Blue (B) Elastomer

Part No.	Nominal Conduit Size
AT21/FL/A	21mm
AT28/FL/A	28mm

To order quote part number, body colour & Elastomer colour, e.g. AT21/FL/A/BLB

Approvals

Blue Elastomer
Version Only



IP Rating

Appropriate Conduit

For use with: Type PA / PI / PR / PADL / PF

IP40	Yes
IP65	Yes
IP68	Yes (4 bar 30mins)
IP69K	Yes

Temperature Range

Static Applications: -50°C to +120°C

Moving Applications: -45°C to +120°C

Fitting Characteristics



Non-metallic conduit systems

Panel Mounting Type FL/C90 & FL45 - Adaptalok ATS™



Panel Mounting Type FL/C90
90° Elbow Body

Panel Mounting Type FL/C90 - Adaptalok ATS™

90° Elbow Body - Panel Mounting Swivel Flange / For panel mounting via 2 hole fixing & integral face seal

Materials: Polyamide (Nylon) 66/TPE / **Colour:** Black (BL), Grey (GR) / Yellow (Y), Blue (B) Elastomer

Part No.	Nominal Conduit Size
AT13/FL/C90	13mm
AT16/FL/C90	16mm
AT21/FL/C90	21mm
AT28/FL/C90	28mm

To order quote part number, body colour & Elastomer colour, e.g. AT21/FL/C90/BLB

Approvals

Blue Elastomer Version Only



IP Rating

Appropriate Conduit

Temperature Range

For use with: Type PA / PI / PR / PADL / PF

Static Applications: -50°C to +120°C

IP40	Yes
IP65	Yes
IP68	Yes (4 bar 30mins)
IP69K	Yes

Moving Applications: -45°C to +120°C

Fitting Characteristics



Panel Mounting Type FL45
45° Elbow Body

Panel Mounting Type FL45 - Adaptalok ATS™

45° Elbow Body - Panel Mounting Swivel Flange / With integral face seal

Materials: Polyamide (Nylon) 66/TPE / **Colour:** Black (BL), Grey (GR) / Yellow (W), Blue (B) Elastomer

Part No.	Nominal Conduit Size
AT16/FL/45	16mm
AT21/FL/45	21mm
AT28/FL/45	28mm
AT54/FL/45	54mm

To order quote part number, body colour & Elastomer colour, e.g. AT21/FL/45/BLB

Approvals

Blue Elastomer Version Only



IP Rating

Appropriate Conduit

Temperature Range

For use with: Type PA / PI / PR / PADL / PF

Static Applications: -50°C to +120°C

IP40	Yes
IP65	Yes
IP68	Yes (4 bar 30mins)
IP69K	Yes

Moving Applications: -45°C to +120°C

Fitting Characteristics



Non-metallic conduit systems

Type T - Adaptalok ATS™

2



Type T
3 Way 'T' Piece

Type T - Adaptalok ATS™

3 Way 'T' Piece / **Materials:** Polyamide (Nylon) 66 / **Colour:** Black (BL), Grey (GR) / Yellow (Y), Blue (B) Elastomer

	Part No.	Nominal Dimensions / Conduit Size				
		A	B	C	D	E
21T	AT211316/T	82mm	129mm	21mm	16mm	13mm
	AT211321/T	82mm	122mm	21mm	21mm	13mm
	AT211613/T	83mm	129mm	21mm	13mm	16mm
	AT211616/T	83mm	129mm	21mm	16mm	16mm
	AT211621/T	83mm	122mm	21mm	21mm	16mm
	AT212113/T	75mm	129mm	21mm	21mm	13mm
	AT211616/T	83mm	129mm	21mm	16mm	16mm
	AT212121/T	77mm	122mm	21mm	21mm	21mm
28T	AT212821/T	82mm	152mm	21mm	21mm	28mm
	AT281321/T	88mm	141mm	28mm	21mm	13mm
	AT281328/T	88mm	129mm	28mm	28mm	13mm
	AT281621/T	90mm	141mm	28mm	21mm	16mm
	AT281628/T	90mm	129mm	28mm	28mm	16mm
	AT282121/T	93mm	141mm	28mm	21mm	21mm
	AT282128/T	93mm	129mm	28mm	28mm	21mm
	AT282828/T	82mm	129mm	28mm	28mm	28mm
34T	AT341634/T	98mm	139mm	34mm	34mm	16mm
	AT342128/T	104mm	150mm	34mm	28mm	21mm
	AT342134/T	104mm	139mm	34mm	34mm	21mm
	AT343434/T	91mm	139mm	34mm	34mm	34mm

To order quote part number, body colour & Elastomer colour, e.g. AT211316/T/BLY

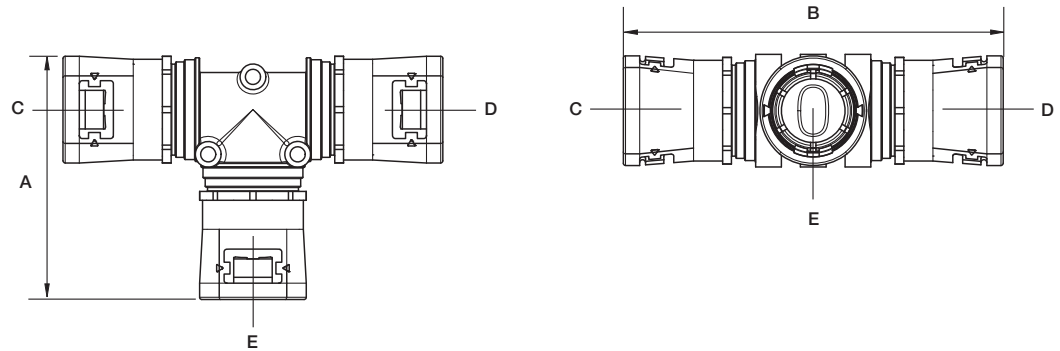

Approvals



IP Rating Appropriate Conduit

For use with: Type PA / PI / PR / PADL / PF

IP66	Yes
IP67	Yes
IP68	Yes (4 bar 30mins)
IP69K	Yes

Temperature Range

Static Applications: -50°C to +120°C

Moving Applications: -45°C to +120°C

Fitting Characteristics



Non-metallic conduit systems

Type Y - Adaptalok ATS™



Type Y
3 way 'Y' Piece

Type Y - Adaptalok ATS™

3 Way 'Y' Piece / **Materials:** Polyamide (Nylon) 66 / **Colour:** Black (BL), Grey (GR) / Yellow (Y), Blue (B) Elastomer

28Y	Part No.	Nominal Dimensions / Conduit Size				
		A	B	C	D	E
	AT282113/Y	107.1mm	117.8mm	28mm	21mm	13mm
	AT282116/Y	110.6mm	117.8mm	28mm	21mm	16mm
	AT282121/Y	116.4mm	129.9mm	28mm	21mm	21mm
	AT282813/Y	108.7mm	124.6mm	28mm	28mm	13mm
	AT282816/Y	112.2mm	124.6mm	28mm	28mm	16mm
	AT282821/Y	116.6mm	124.6mm	28mm	28mm	21mm
	AT282828/Y	165.0mm	119.0mm	28mm	28mm	28mm

To order quote part number, body colour & Elastomer colour, e.g. AT282113/Y/BLY

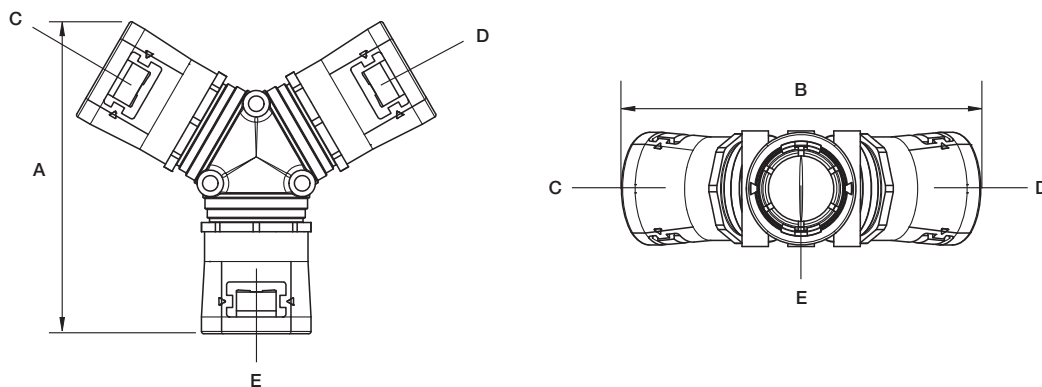

Approvals



IP Rating

Appropriate Conduit

For use with: Type PA / PI / PR / PADL / PF

IP40	Yes
IP65	Yes
IP68	Yes (4 bar 30mins)
IP69K	Yes

Temperature Range

Static Applications: -50°C to +120°C

Moving Applications: -45°C to +120°C

Fitting Characteristics



Non-metallic conduit systems

Type A & C90 - Adaptaseal

2



Type A
Straight Fitting

Type A - Adaptaseal

Straight Fitting - Fixed External Male Thread / For insertion into knockouts using a locknut. Locknut supplied with METRIC THREAD ONLY

Materials: Polyamide (Nylon) 66 / **Colour:** Black (BL), Grey (GR)

Part No.	Nominal Conduit Size	Metric Thread	Part No.	Nominal Conduit Size	PG Thread
ASF10/M16/A	10mm	M16	ASF10/PG9/A	10mm	PG9
ASF13/M16/A	13mm	M16	ASF13/PG9/A	13mm	PG9
ASF16/M16/A	16mm	M16	ASF16/PG11/A	16mm	PG11
ASF16/M20/A	16mm	M20	ASF16/PG13/A	16mm	PG13,5
ASF21/M20/A	21mm	M20	ASF21/PG16/A	21mm	PG16
ASC21/M20/A	21mm	M20	ASC21/PG16/A	21mm	PG16
ASF28/M25/A	28mm	M25	ASF28/PG21/A	28mm	PG21
ASC28/M25/A	28mm	M25	ASC28/PG21/A	28mm	PG21
ASF34/M32/A	34mm	M32	ASF34/PG29/A	34mm	PG29
ASC34/M32/A	34mm	M32	ASC34/PG29/A	34mm	PG29
ASC42/M40/A	42mm	M40	ASC42/PG36/A	42mm	PG36
ASC54/M50/A	54mm	M50	ASC54/PG48/A	54mm	PG48

To order quote part number & body colour, e.g. ASF10/M16/A/BL

PF & NPT thread sizes available

Approvals



IP Rating	Appropriate Conduit	Temperature Range
For use with: Type PA / PI / CP / PR / PF		
IP66	Yes	Static Applications: -40°C to +120°C
IP67	Yes	Moving Applications: -5°C to +120°C
IP68	Yes (2 bar 30mins)	
IP69K	Yes	



Type C90
90° Elbow Fitting

Type C90 - Adaptaseal

90° Elbow Fitting - Fixed External Male Thread / For insertion into knockouts using a locknut. Locknut supplied with METRIC THREAD ONLY

Materials: Polyamide (Nylon) 66 / **Colour:** Black (BL), Grey (GR)

Part No.	Nominal Conduit Size	Metric Thread	Part No.	Nominal Conduit Size	PG Thread
ASF10/M16/C90	10mm	M16	ASF10/PG9/C90	10mm	PG9
ASF13/M16/C90	13mm	M16	ASF13/PG9/C90	13mm	PG9
ASF16/M16/C90	16mm	M16	ASF16/PG11/C90	16mm	PG11
ASF16/M20/C90	16mm	M20	ASF16/PG13/C90	16mm	PG13,5
ASF21/M20/C90	21mm	M20	ASF21/PG16/C90	21mm	PG16
ASC21/M20/C90	21mm	M20	ASC21/PG16/C90	21mm	PG16
ASF28/M25/C90	28mm	M25	ASF28/PG21/C90	28mm	PG21
ASC28/M25/C90	28mm	M25	ASC28/PG21/C90	28mm	PG21
ASF34/M32/C90	34mm	M32	ASF34/PG29/C90	34mm	PG29
ASC34/M32/C90	34mm	M32	ASC34/PG29/C90	34mm	PG29
ASC42/M40/C90	42mm	M40	ASC42/PG36/C90	42mm	PG36
ASC54/M50/C90	54mm	M50	ASC54/PG48/C90	54mm	PG48

To order quote part number & body colour, e.g. ASF10/M16/C90/BL

PF & NPT thread sizes available

Approvals



IP Rating	Appropriate Conduit	Temperature Range
For use with: Type PA / PI / CP / PR / PF		
IP66	Yes	Static Applications: -40°C to +120°C
IP67	Yes	Moving Applications: -5°C to +120°C
IP68	Yes (2 bar 30mins)	
IP69K	Yes	

Non-metallic conduit systems

Type FLC90/FL90 & T - Adaptaseal



Type FLC90/FL90
90° Elbow Fitting



Type FLC90/FL90 - Adaptaseal

90° Elbow Body - Panel Mount Swivel Flange / For panel mounting via 2/4 hole fixing & integral face seal

Materials: Polyamide (Nylon) 66 / **Colour:** Black (BL) Only

Part No.	Nominal Conduit Size
ASF13/FL/C90	13mm
ASF16/FL/C90	16mm
ASF21/FL/C90	21mm
ASC21/FL/C90	21mm
ASF28/FL/C90	28mm
ASC28/FL/C90	28mm
ASF34/FL/90*	34mm
ASC34/FL/90*	34mm
ASC42/FL/90*	42mm
ASC54/FL/90*	54mm

To order quote part number & body colour, e.g. ASF13/FL/C90/BL

*These sizes are fixed panel mounting - non swivel

Approvals



IP Rating	Appropriate Conduit	Temperature Range
For use with: Type PA / PI / CP / PR / PF		
IP66	Yes	Static Applications: -40°C to +120°C Moving Applications: -5°C to +120°C
IP67	Yes	
IP68	Yes (2 bar 30mins)	
IP69K	Yes	



Type T
Inspection T-Piece

Type T - Adaptaseal

Inspection T-Piece / For connection to corrugated flexible conduit

Materials: Polyamide (Nylon) 66 / **Colour:** Black (BL) Only

Part No.	Nominal Conduit Size
ASF10X3/T	10mm
ASF13X3/T	13mm
ASF16X3/T	16mm
ASF21X3/T	21mm
ASC21X3/T	21mm
ASF28X3/T	28mm
ASC28X3/T	28mm
ASF34X3/T	34mm
ASC34X3/T	34mm

To order quote part number & body colour, e.g. ASF10X3/T/BL

Approvals



IP Rating	Appropriate Conduit	Temperature Range
For use with: Type PA / PI / CP / PR / PF		
IP66	Yes	Static Applications: -40°C to +120°C Moving Applications: -5°C to +120°C
IP67	Yes	
IP68	N/A	
IP69K	N/A	

Non-metallic conduit systems

Type RK & AWB - Adaptaseal

2

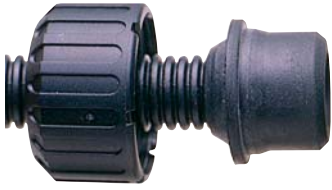

Type RK
Reducing Kit

Type RK - Adaptaseal

Reducing Kit / For connection to a reduced conduit size

Materials: Polyamide (Nylon) 66 & Neoprene Rubber / **Colour:** Black (BL) Only

Nominal Conduit Size	Conduit Pitch	Part No.				
		Reducing to Conduit Size 10	Reducing to Conduit Size 13	Reducing to Conduit Size 16	Reducing to Conduit Size 21	Reducing to Conduit Size 28
10mm	Fine					
13mm	Fine	RK13-10				
16mm	Fine	RK16-10	RK16-13			
21mm	Fine	RK21-10	RK21-13	RK21-16		
21mm	Coarse	RK21-10	RK21-13	RK21-16		
28mm	Fine		RK28-13	RK28-16	RK28-21	
28mm	Coarse		RK28-13	RK28-16	RK28-21	
34mm	Fine				RK34-21	RK34-28
34mm	Coarse				RK34-21	RK34-28

To order quote part number, e.g. RK13-10/BL

Approvals



IP Rating

Appropriate Conduit

For use with: Type PA / PI / CP / PR / PF

IP66	Yes
IP67	Yes
IP68	N/A
IP69K	N/A

Temperature Range

Static Applications: -40°C to +120°C

Moving Applications: -5°C to +120°C



Type AWB
Anti-Vibration Washer

Type AWB - Adaptaseal

Anti-Vibration Washer / Prevents fitting loosening under vibration

Materials: Acetal (POM) / **Colour:** Black (BL) Only

Part No.	Nominal Conduit Size
AWB13	13mm
AWB16	16mm
AWB21	21mm
AWB28	28mm
AWB34	34mm

Non-metallic conduit systems

Type A & C90 - Adapting



Type A
Straight Fitting

Type A - Adapting

Straight Fitting - Fixed External Male Thread / For insertion into threaded entries & knockouts. Locknut supplied with METRIC THREAD ONLY

Materials: Polyamide (Nylon) 66 & Acetal (POM) / **Colour:** Black (BL) Only

Part No.	Nominal Conduit Size	Metric Thread	Part No.	Nominal Conduit Size	PG Thread
AR13/M16/A	13mm	M16	AR13/PG9/A	13mm	PG9
AR16/M16/A	16mm	M16	AR16/PG11/A	16mm	PG11
AR16/M20/A	16mm	M20	AR16/PG13/A	16mm	PG13,5
AR21/M20/A	21mm	M20	AR21/PG16/A	21mm	PG16
AR28/M25/A	28mm	M25	AR28/PG21/A	28mm	PG21
AR34/M32/A	34mm	M32	AR34/PG29/A	34mm	PG29
AR42/M40/A	42mm	M40	AR42/PG36/A	42mm	PG36
AR54/M50/A	54mm	M50	AR54/PG48/A	54mm	PG48

To order quote part number, e.g. AR21/M20/A/BL
PF & NPT thread sizes available

Approvals



IP Rating

Appropriate Conduit

For use with: Type PA / PI / CP / PR / PF

IP40	Yes
IP65	N/A
IP66	N/A
IP67	N/A
IP68	N/A
IP69K	N/A

Temperature Range

Static Applications: -40°C to +120°C
Moving Applications: -5°C to +120°C

Fitting Characteristics



Type C90
90° Elbow Fitting

Type C90 - Adapting

90° Elbow Fitting - Fixed External Male Thread / For insertion into knockouts. Locknut supplied with METRIC THREAD ONLY

Materials: Polyamide (Nylon) 66 & Acetal (POM) / **Colour:** Black (BL) Only

Part No.	Nominal Conduit Size	Metric Thread
AR13/M16/C90	13mm	M16
AR16/M16/C90	16mm	M16
AR16/M20/C90	16mm	M20
AR21/M20/C90	21mm	M20
AR28/M25/C90	28mm	M25
AR34/M32/C90	34mm	M32
AR42/M40/C90	42mm	M40
AR54/M50/C90	54mm	M50

To order quote part number & body colour, e.g. AR21/M20/C90/BL
PF & NPT thread sizes available

Approvals



IP Rating

Appropriate Conduit

For use with: Type PA / PI / CP / PR / PF

IP40	Yes
IP65	N/A
IP66	N/A
IP67	N/A
IP68	N/A
IP69K	N/A

Temperature Range

Static Applications: -40°C to +120°C
Moving Applications: -5°C to +120°C

Fitting Characteristics



Non-metallic conduit systems

Type T & AWB - Adapting

2



Type T
Rotational Inspection T-Piece

Type T - Adapting

Rotational Inspection T-Piece / For connection to corrugated flexible conduit

Materials: Polyamide (Nylon) 66 & Acetal (POM) / **Colour:** Black (BL) Only

Part No.	Nominal Conduit Size
AR13X3/T	13mm
AR16X3/T	16mm
AR21X3/T	21mm
AR28X3/T	28mm
AR34X3/T	34mm

To order quote part number, e.g. AR13X3/T/BL

Approvals



IP Rating	Appropriate Conduit	Temperature Range
For use with: Type PA / PI / CP / PR / PF		Static Applications: -40°C to +120°C
IP40	Yes	Moving Applications: -5°C to +120°C
IP65	N/A	
IP66	N/A	
IP67	N/A	
IP68	N/A	
IP69K	N/A	

Fitting Characteristics



Type AWB
Anti-Vibration Washer

Type AWB - Adapting

Anti-Vibration Washer / Prevents fitting loosening under vibration

Materials: Acetal (POM) / **Colour:** Black (BL) Only

Part No.	Nominal Conduit Size
AWB13	13mm
AWB16	16mm
AWB21	21mm
AWB28	28mm
AWB34	34mm

Non-metallic conduit systems

Type KF - Korifit



Type KF
Lightweight Conduit

Type KF - Korifit

Lightweight Conduit / **Materials:** PVCu / **Colour:** Grey (GR) Only

Part No.	Nominal Conduit Size	NW Conduit Size	Conduit Pitch	Outside Diameter	Inside Diameter	Min. Bend Radius	Reel Length
KFL16	16mm	13	Fine	15.8mm	12.1mm	25mm	50m
KFL20	20mm	17	Fine	19.8mm	14.5mm	30mm	50m
KFL25	25mm	22	Fine	24.8mm	19.9mm	40mm	50m

To order quote part number, colour & reel length, e.g. KFL16/GR/50M



Type KF
Standard Weight Conduit

Type KF - Korifit

Standard Weight Conduit / **Materials:** PVCu / **Colour:** White (W) Only

Part No.	Nominal Conduit Size	NW Conduit Size	Conduit Pitch	Outside Diameter	Inside Diameter	Min. Bend Radius	Reel Length
KFS16	16mm	13	Fine	15.8mm	11.9mm	25mm	50m
KFS20	20mm	17	Fine	19.8mm	14.3mm	30mm	50m
KFS25	25mm	22	Fine	24.8mm	19.7mm	40mm	50m

To order quote part number, colour & reel length, e.g. KFS16/W/50M



Type KF
Medium Weight Conduit

Type KF - Korifit

Medium Weight Conduit / **Materials:** PVCu / **Colour:** Black (BL) Only

Part No.	Nominal Conduit Size	NW Conduit Size	Conduit Pitch	Outside Diameter	Inside Diameter	Min. Bend Radius	Reel Length
KFM16	16mm	13	Fine	15.8mm	11.9mm	25mm	50m
KFM20	20mm	17	Fine	19.8mm	14.3mm	30mm	50m
KFM25	25mm	22	Fine	24.8mm	19.7mm	40mm	50m

To order quote part number, colour & reel length, e.g. KFM16/BL/50M

Approvals



IP Rating	Appropriate Fitting	Temperature Range	UV Resistance
For use with: Korifit KC & KF		Static Applications: -5°C to +60°C	High
IP40	Korifit KC	Moving Applications: -5°C to +60°C	
IP65	Korifit KF	Flexibility & Fatigue Life	
IP66	N/A	Pliable - Low Fatigue Life	
IP67	N/A	Fire Performance & EMI Screen	
IP68	N/A	Self Extinguishing	
IP69K	N/A		

Non-metallic conduit systems

Type KC/A & KC/C90 - Korifit

2



Type KC/A
Straight Fitting

Type KC/A - Korifit

Straight Fitting - Fixed External Male Thread / For insertion into threaded entries & knockouts. Locknut supplied

Materials: Polyamide (Nylon) 66 / **Colour:** Black (BL), Grey (GR), White (W)

Part No.	Nominal Conduit Size	Metric Thread
KC16/M16/A	16mm	M16
KC16/M20/A	16mm	M20
KC20/M20/A	20mm	M20
KC25/M25/A	20mm	M25

To order quote part number & body colour, e.g. KC16/M16/A/BL

Approvals



IP Rating	Appropriate Conduit	Temperature Range
For use with: Korifit Type KF		
IP40	Yes	Static Applications: -5°C to +60°C
IP65	N/A	Moving Applications: -5°C to +60°C
IP66	N/A	
IP67	N/A	
IP68	N/A	
IP69K	N/A	

Fitting Characteristics



Type KC/C90
90° Elbow Fitting

Type KC/C90 - Korifit

90° Elbow Fitting - Fixed External Male Thread / For insertion into knockouts. Locknut supplied

Materials: Polyamide (Nylon) 66 / **Colour:** Black (BL) Only

Part No.	Nominal Conduit Size	Metric Thread
KC16/M16/C90	16mm	M16
KC20/M20/C90	20mm	M20
KC25/M25/C90	25mm	M25

To order quote part number & body colour, e.g. KC16/M16/C90/BL

Approvals



IP Rating	Appropriate Conduit	Temperature Range
For use with: Korifit Type KF		
IP40	Yes	Static Applications: -5°C to +60°C
IP65	N/A	Moving Applications: -5°C to +60°C
IP66	N/A	
IP67	N/A	
IP68	N/A	
IP69K	N/A	

Non-metallic conduit systems

Type KF/A & Coupler - Korifit



Type KF/A
Straight Fitting

Type KF/A - Korifit

Straight Fitting - Fixed External Male Thread / For insertion into threaded entries & knockouts. Locknut supplied

Materials: Polyamide (Nylon) 66 / **Colour:** Black (BL), Grey (GR), White (W)

Part No.	Nominal Conduit Size	Metric Thread
KF16/M16/A	16mm	M16
KF16/M20/A	16mm	M20
KF20/M20/A	20mm	M20
KF25/M25/A	25mm	M25

To order quote part number & body colour, e.g. KF16/M16/A/BL

Approvals



IP Rating	Appropriate Conduit	Temperature Range
For use with: Korifit Type KF		
IP40	N/A	Static Applications: -5°C to +60°C
IP65	Yes	Moving Applications: -5°C to +60°C
IP66	N/A	
IP67	N/A	
IP68	N/A	
IP69K	N/A	

Fitting Characteristics



Coupler
Straight One Piece Coupler

Coupler - Korifit

Straight One Piece Coupler / For coupling two corrugated flexible conduits

Materials: Polyamide (Nylon) 66 / **Colour:** Colour White (W) Only

Part No.	Nominal Conduit Size	NW Conduit Size
KF2020	20mm	17

To order quote part number & body colour, e.g. KF2020/W

Approvals



IP Rating	Appropriate Conduit	Temperature Range
For use with: Korifit Type KF		
IP40	N/A	Static Applications: -5°C to +60°C
IP65	Yes	Moving Applications: -5°C to +60°C
IP66	N/A	
IP67	N/A	
IP68	N/A	
IP69K	N/A	

Non-metallic conduit systems

Polypropylene Type PP & PPA - Adaptalok

2



Type PP
Medium Weight Conduit

Polypropylene Type PP - Adaptalok

Medium Weight Conduit / Materials: Polypropylene / Colour: Black (BL) Only

Part No.	Nominal Conduit Size	NW Conduit Size	Outside Diameter	Inside Diameter	Min. Bend Radius	Reel Length
PPFM13	13mm	10	13.0mm	9.8mm	5mm	50m
PPFM16	16mm	13	15.8mm	12.1mm	35mm	50m
PPFM21	21mm	17	21.2mm	16.8mm	40mm	50m
PPFM28	28mm	23	28.5mm	23.1mm	60mm	50m
PPFM34	34mm	29	34.5mm	29.1mm	50mm	50m

To order quote part number, colour & reel length, e.g. PPFM16/BL/50M

Approvals



IP Rating	Appropriate Fitting	Temperature Range	UV Resistance
For use with: Polypropylene Type PPA		Static Applications: -20°C to +90°C Moving Applications: -5°C to +105°C	Medium
IP40	N/A	Flexibility & Fatigue Life High Flexibility - Medium Fatigue Life	
IP65	N/A		
IP66	Polypropylene Type PPA		
IP67	N/A		
IP68	N/A		
IP69K	N/A		



Type PPA
Straight Fitting

Polypropylene Type PPA - Adaptalok

Straight Fitting - Fixed External Male Thread / For insertion into knockouts using locknuts. Locknuts supplied

Materials: Polypropylene / Colour: Black (BL) Only

Part No.	Nominal Conduit Size	Metric Thread
AL13/M16/PPA	13mm	M16
AL16/M16/PPA	16mm	M16
AL21/M20/PPA	21mm	M20
AL28/M25/PPA	28mm	M25
AL34/M32/PPA	34mm	M32

To order quote part number & body colour, e.g. AL21/M20/PPA/BL

Approvals



IP Rating	Appropriate Conduit	Temperature Range	Fitting Characteristics
For use with: Polypropylene Type PP		Static Applications: -20°C to +90°C Moving Applications: -5°C to +105°C	
IP40	N/A		
IP65	N/A		
IP66	Yes		
IP67	N/A		
IP68	N/A		
IP69K	N/A		

Non-metallic conduit systems

PVC Type XF & RF - Xtraflex / RF



Type XF
Standard Weight Conduit

PVC Type XF - Xtraflex

Standard Weight Conduit / **Materials:** PVCu Spiral with Plasticised PVC Covering / **Colour:** Black (BL) Only

Part No.	Nominal Conduit Size	Outside Diameter	Inside Diameter	Min. Bend Radius	Reel Length
XF12	12mm	14.5mm	10mm	25mm	30m
XF16	16mm	16.5mm	12mm	30mm	30m
XF20	20mm	20.5mm	16mm	35mm	30m
XF25	25mm	27.5mm	22mm	50mm	30m
XF32	32mm	33.5mm	28mm	60mm	30m
XF40	40mm	44.0mm	38mm	80mm	30m
XF50	50mm	57.5mm	50mm	105mm	30m

To order quote part number & reel length, e.g. XF16/30M

Approvals

IP Rating	Appropriate Fitting	Temperature Range	UV Resistance
For use with: Type XF		Static Applications: -5°C to +60°C	High
IP40	N/A	Moving Applications: -5°C to +60°C	
IP65	Type XF	Flexibility & Fatigue Life	
IP66	N/A	Very High Flexibility - Medium Fatigue Life	
IP67	N/A	Fire Performance & EMI Screen	
IP68	N/A	Self Extinguishing	
IP69K	N/A		



Type RF
Heavyweight Conduit
Smooth Bore

PVC Type RF - RF

Heavyweight Conduit - Smooth Bore

Materials: PVCu Spiral with Plasticised PVC Covering / **Colour:** Black (BL), Grey (GR)

Part No.	Nominal Conduit Size	Outside Diameter	Inside Diameter	Min. Bend Radius	Reel Length
RF12	12mm	14.5mm	10mm	25mm	30m
RF16	16mm	16.5mm	12mm	30mm	30m
RF20	20mm	20.5mm	16mm	35mm	30m
RF25	25mm	27.5mm	22mm	50mm	30m
RF32	32mm	33.5mm	28mm	60mm	30m

To order quote part number, colour & reel length, e.g. RF16/BL/30M

Approvals

IP Rating	Appropriate Fitting	Temperature Range	UV Resistance
For use with: Type RF		Static Applications: -20°C to +60°C	High
IP40	N/A	Moving Applications: -5°C to +60°C	
IP65	N/A	Flexibility & Fatigue Life	
IP66	N/A	Medium Flexibility - Medium Fatigue Life	
IP67	Type RF	Fire Performance & EMI Screen	
IP68	N/A	Self Extinguishing	
IP69K	N/A		

Non-metallic conduit systems

PVC Type A & C90 - XF

2



Type A
Straight Fitting

Type A - XF

Straight Fitting - Fixed External Male Thread / For insertion into threaded entries & knockouts. Locknuts supplied with METRIC THREAD ONLY

Materials: Polyamide (Nylon) 66 / **Colour:** Black (BL) Only

Part No.	Nominal Conduit Size	Metric Thread
XF12/M16/D	12mm	M16
XF16/M16/D	16mm	M16
XF16/M20/D	16mm	M20
XF20/M20/D	20mm	M20
XF25/M25/D	25mm	M25
XF32/M32/D	32mm	M32
XF40/M40/D	40mm	M40
XF50/M50/D	50mm	M50

To order quote part number, e.g. XF16/M16/D

Approvals



IP Rating	Appropriate Conduit	Temperature Range
For use with: Xtraflex Type XF		
IP40	N/A	Static Applications: -5°C to +60°C
IP65	Yes	Moving Applications: -5°C to +60°C
IP66	N/A	Fitting Characteristics 
IP67	N/A	
IP68	N/A	
IP69K	N/A	



Type C90
90° Elbow Fitting

Type C90 - XF

90° Elbow Fitting - Fixed External Male Thread / For insertion into knockouts. Locknuts supplied with METRIC THREAD ONLY

Materials: Polyamide (Nylon) 66 / **Colour:** Black (BL) Only

Part No.	Nominal Conduit Size	Metric Thread
XF16/M16/C90	16mm	M16
XF20/M20/C90	20mm	M20
XF25/M25/C90	25mm	M25
XF32/M32/C90	32mm	M32

To order quote part number, e.g. XF16/M16/C90

Approvals



IP Rating	Appropriate Conduit	Temperature Range
For use with: Xtraflex Type XF		
IP40	N/A	Static Applications: -5°C to +60°C
IP65	Yes	Moving Applications: -5°C to +60°C
IP66	N/A	
IP67	N/A	
IP68	N/A	
IP69K	N/A	

Non-metallic conduit systems

PVC Type A & C90 - RF



Type A
Straight Fitting

Type A - RF

Straight Fitting - Fixed External Male Thread / For insertion into threaded entries & knockouts. Locknuts supplied with METRIC THREAD ONLY

Materials: Polyamide (Nylon) 66 / **Colour:** Black (BL) Only

Part No.	Nominal Conduit Size	Metric Thread
RF12/M16/A	12mm	M16
RF16/M16/A	16mm	M16
RF16/M20/A	16mm	M20
RF20/M20/A	20mm	M20
RF25/M25/A	25mm	M25
RF32/M32/A	32mm	M32

To order quote part number, e.g. XF16/M16/A

Approvals



IP Rating	Appropriate Conduit	Temperature Range
For use with: Xtraflex Type RF		Static Applications: -5°C to +60°C
IP40	N/A	Moving Applications: -5°C to +60°C
IP65	N/A	Fitting Characteristics 
IP66	N/A	
IP67	Yes	
IP68	N/A	
IP69K	N/A	



Type C90
90° Elbow Fitting

Type C90 - RF

90° Elbow Fitting - Fixed External Male Thread / For insertion into knockouts. Locknuts supplied with METRIC THREAD ONLY

Materials: Polyamide (Nylon) 66 / **Colour:** Black (BL) Only

Part No.	Nominal Conduit Size	Metric Thread
RF16/M16/C90	16mm	M16
RF20/M20/C90	20mm	M20
RF25/M25/C90	25mm	M25
RF32/M32/C90	32mm	M32

To order quote part number, e.g. XF16/M16/C90

Approvals



IP Rating	Appropriate Conduit	Temperature Range
For use with: Xtraflex Type RF		Static Applications: -5°C to +60°C
IP40	N/A	Moving Applications: -5°C to +60°C
IP65	N/A	
IP66	N/A	
IP67	Yes	
IP68	N/A	
IP69K	N/A	

Non-metallic conduit systems

Accessories - Type LNP, SW & AC

2



Type LNP
Nylon Locknuts

Type LNP

Nylon Locknuts / **Materials:** Polyamide (Nylon) 6 / **Colour:** Black (BL), Grey (GR)

Part No.			Metric Thread		Part No.		PG Thread
Black	Grey				Black	Grey	
LNPB/M12	-		M12		LNPB/PG7	LNPG/PG7	PG7
LNPB/M16	LNPG/M16		M16		LNPB/PG9	LNPG/PG9	PG9
LNPB/M20	LNPG/M20		M20		LNPB/PG11	LNPG/PG11	PG11
LNPB/M25	LNPG/M25		M20		LNPB/PG13	LNPG/PG13	PG13
LNPB/M32	LNPG/M32		M20		LNPB/PG16	LNPG/PG16	PG16
LNPB/M40	LNPG/M40		M20		LNPB/PG21	LNPG/PG21	PG21
LNPB/M50	LNPG/M50		M32		LNPB/PG29	LNPG/PG29	PG29
LNPB/M63	LNPG/M63		M20		LNPB/PG36	LNPG/PG36	PG36
					LNPB/PG42	LNPG/PG42	PG42
					LNPB/PG48	LNPG/PG48	PG48



Type SW
Thread Sealing Washer

Type SW

Thread Sealing Washer - Captive / Rubber - For use with Nylon threaded fittings. Nylon - For use with swivel metal threaded fittings

Materials: Rubber or Nylon / **Colour:** Black (BL), Yellow (Y), Blue (B)

Part No.	Metric Thread	Part No.	NPT & PF Thread (Black Only)
SWM12	M12	SW038	3/8"
SWM16	M16	SW050	1/2"
SWM20	M20	SW075	3/4"
SWM25	M25	SW100	1"
SWM32	M32	SW125	1 1/4"
SWM40	M40	SW150	1 1/2"
SWM50	M50	SW200	2"
SWM63	M63		

To order quote part number & body colour, e.g. Rubber / Yellow - SWM12/Y, Nylon / Blue - SWM20/NB



Type AC
Conduit Clips

Type AC

Conduit Clips / With integral lid

Materials: Polyamide (Nylon) 66, Impact Modified Nylon - ST Version Only / **Colour:** Black (BL), Grey (GR)

Part No.			Nominal Conduit Size
Black	Grey	Impact Modified (Black Only)	
ACB10	ACG10		10mm
ACB13	ACG13	ACB13/ST	13mm
ACB16	ACG16	ACB16/ST	16mm
ACB21	ACG21	ACB21/ST	21mm
ACB28	ACG28	ACB28/ST	28mm
ACB34	ACG34	ACB34/ST	34mm
ACB42	ACG42	ACB42/ST	42mm
ACB48	ACG48	ACB48/ST	48mm
ACB54	ACG54	ACB54/ST	54mm

Non-metallic conduit systems

Accessories - Type GZ, EC & RT



Type GZ
End Sleeves

Type GZ

End Sleeves / For sealing cables to non-metallic conduit

Materials: Rubber / **Colour:** Black (BL) Only

Part No.	Nominal Conduit Size
GZ9	13mm
GZ11	16mm
GZ13	21mm
GZ21	28mm
GZ29	34mm
GZ36	42mm



Type EC
End Caps

Type EC

End Caps / Provides a smooth finish to conduit preventing any damage to cables when not terminated with a fitting

Materials: Acetal (POM) / **Colour:** Black (BL) Only

Part No.	Nominal Conduit Size
ECB13	13mm
ECB16	16mm
ECB21	21mm
ECB28	28mm
ECB34	34mm
ECB42	42mm
ECB54	54mm



Type RT
Adaptalok Removal Tool

Type RT

Adaptalok Removal Tool / To provide easy removal of Adaptalok & ATS Fittings

Materials: Polyamide (Nylon) 6 / **Colour:** Black (BL) Only

Part No.	Adaptalok Fitting Size
AL13RT	13mm
AL16RT	16mm
AL21RT	21mm
AL28RT	28mm
AL34RT	34mm
AL42RT	42mm
AL54RT	54mm

NOTE: For a 13-34mm set use part number ALRTSET

Non-metallic conduit systems

Accessories - Type MB

2



Type MB
Manifold Box

Type MB

Manifold Box - Multiway Adapters / Non metallic enclosure which can be machined to take upto eight Adaptalok ATS™ fittings

Materials: Polyamide (Nylon) 66/TPE / **Colour:** Black (BL) Only / Yellow (Y) Elastomer

Part No.	External Dimensions Lid (mm) Dia X Height	External Dimensions Fixing Lugs (mm)	Max Threaded Entry Per Face
MB21	100 x 40	120	M20
MB34	136 x 55	155	M32

To order quote part number, body colour & Elastomer colour, e.g. MB21/BLY

Non metallic enclosure which can be machined to take upto eight Adaptalok ATS™ fittings (or other devices) in a variety of configurations and sizes, e.g. 'Y', 'T', 'X', 'V' etc. Each box has a removable cover for ease of access. The box seal is moulded, so remains captive. Each manifold is provided with eight blank sides which require drilling/machining to suit the application. Manifolds can be supplied ready drilled to order, subject to minimum order quantities. Threaded fittings with locknuts can be used in each entry.

Approvals



IP Rating	Appropriate Fitting	Temperature Range	UV Resistance
For use with: All threaded fittings in this catalogue		Static Applications: -50°C to +120°C	Very High
IP66	Yes	Moving Applications: -45°C to +120°C	
IP67	Yes		
IP68	Yes (2 bar 30mins)		
IP69K	Yes		

Non-metallic conduit systems

Accessories - Type T, Hinged 'T' Piece



Type PA
Hinged 'T' Piece

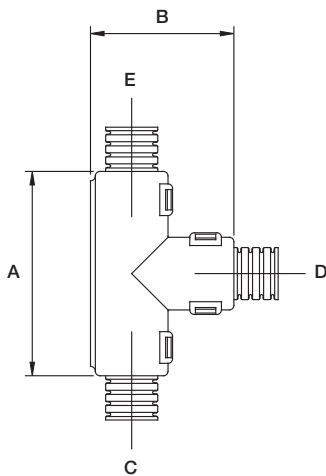

Type T

Hinged 'T' Piece / **Materials:** Polyamide (Nylon) 66 / **Colour:** Black (BL), Grey (GR)

	Part No.	Nominal Dimensions / Conduit Size					
		A	B	C	D	E	
10T	T101010/BL	45.2mm	31.1mm	10mm	10mm	10mm	
	T101310/BL	45.2mm	31.1mm	10mm	13mm	10mm	
	T101613/BL	45.2mm	31.1mm	10mm	16mm	13mm	
13T	T131010/BL	45.2mm	31.1mm	13mm	10mm	10mm	
	T131013/BL	45.2mm	31.1mm	13mm	10mm	13mm	
	T131310/BL	45.2mm	31.1mm	13mm	13mm	10mm	
	T131313/BL	45.2mm	31.1mm	13mm	13mm	13mm	
	T131613/BL	45.2mm	31.1mm	13mm	16mm	13mm	
16T	T161013/BL	49.1mm	34.8mm	16mm	10mm	13mm	
	T161313/BL	49.1mm	34.8mm	16mm	13mm	13mm	
	T161316/BL	49.1mm	34.8mm	16mm	13mm	16mm	
	T161613/BL	49.1mm	34.8mm	16mm	16mm	13mm	
	T161616/BL	49.1mm	34.8mm	16mm	16mm	16mm	
	T162113/BL	49.1mm	34.8mm	16mm	21mm	13mm	
	T162116/BL	49.1mm	34.8mm	16mm	21mm	16mm	
21T	T211016/BL	56.5mm	41.0mm	21mm	10mm	16mm	
	T211021/BL	56.5mm	41.0mm	21mm	10mm	21mm	
	T211316/BL	56.5mm	41.0mm	21mm	13mm	16mm	
	T211321/BL	56.5mm	41.0mm	21mm	13mm	21mm	
	T211613/BL	56.5mm	41.0mm	21mm	16mm	13mm	
	T211616/BL	56.5mm	41.0mm	21mm	16mm	16mm	
	T211621/BL	56.5mm	41.0mm	21mm	16mm	21mm	
	T212113/BL	56.5mm	41.0mm	21mm	21mm	13mm	
	T212116/BL	56.5mm	41.0mm	21mm	21mm	16mm	
	T212121/BL	56.5mm	41.0mm	21mm	21mm	21mm	
	28T	T281021/BL	64.5mm	48.5mm	28mm	10mm	21mm
		T281028/BL	64.5mm	48.6mm	28mm	10mm	28mm
T281321/BL		64.5mm	48.6mm	28mm	13mm	21mm	
T281328/BL		64.5mm	48.6mm	28mm	13mm	28mm	
T281621/BL		64.5mm	48.6mm	28mm	16mm	21mm	
T281628/BL		64.5mm	48.6mm	28mm	16mm	28mm	
T282121/BL		64.5mm	48.6mm	28mm	21mm	21mm	
T282128/BL		64.5mm	48.6mm	28mm	21mm	28mm	
T282828/BL		64.5mm	48.6mm	28mm	28mm	28mm	
34T		T341634/BL	72.0mm	55.3mm	34mm	16mm	34mm
	T342128/BL	72.0mm	55.3mm	34mm	21mm	28mm	
	T342134/BL	72.0mm	55.3mm	34mm	21mm	34mm	
	T343434/BL	72.0mm	55.3mm	34mm	34mm	34mm	

Approvals



IP Rating

For use with: Type PA / PI / PR / PF

IP40	Yes
IP65	N/A
IP66	N/A
IP67	N/A
IP68	N/A
IP69K	N/A

Temperature Range

Static Applications: -40°C to +120°C

Moving Applications: -5°C to +120°C

Fitting Characteristics

Snap Fit

Non-metallic conduit systems

Accessories - Type Y, Hinged 'Y' Piece

2



Type Y
Hinged 'Y' Piece

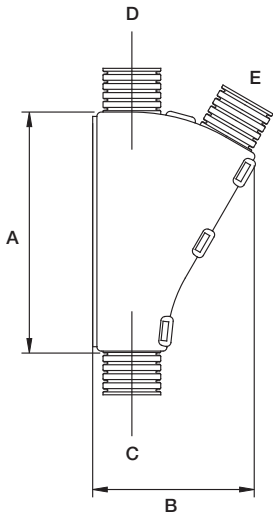

Type Y

Hinged 'Y' Piece / **Materials:** Polyamide (Nylon) 66 / **Colour:** Black (BL) Only

	Part No.	Nominal Dimensions / Conduit Size				
		A	B	C	D	E
10Y	Y101010/BL	54.6mm	37.1mm	10mm	10mm	10mm
	Y101013/BL	54.6mm	37.1mm	10mm	10mm	13mm
	Y101210/BL	54.6mm	37.1mm	10mm	12mm	10mm
13Y	Y131010/BL	54.6mm	37.1mm	13mm	10mm	10mm
	Y131011/BL	54.6mm	37.1mm	13mm	10mm	11mm
	Y131310/BL	54.6mm	37.1mm	13mm	13mm	10mm
	Y131313/BL	54.6mm	37.1mm	13mm	13mm	13mm
16Y	Y161013/BL	54.9mm	39.8mm	16mm	10mm	13mm
	Y161310/BL	54.9mm	39.8mm	16mm	13mm	10mm
	Y161313/BL	54.9mm	39.8mm	16mm	13mm	13mm
	Y161610/BL	54.9mm	39.8mm	16mm	16mm	10mm
	Y161613/BL	54.9mm	39.8mm	16mm	16mm	13mm
21Y	Y211010/BL	42.8mm	41.0mm	21mm	10mm	10mm
	Y211310/BL	42.8mm	41.0mm	21mm	13mm	10mm
	Y211313/BL	42.8mm	41.0mm	21mm	13mm	13mm
	Y211610/BL	48.2mm	39.8mm	21mm	16mm	10mm
	Y211613/BL	48.2mm	39.6mm	21mm	16mm	13mm
	Y211616/BL	63.6mm	47.5mm	21mm	16mm	16mm
	Y212110/BL	57.9mm	44.9mm	21mm	21mm	10mm
	Y212113/BL	57.9mm	44.9mm	21mm	21mm	13mm
	Y212116/BL	63.6mm	47.5mm	21mm	21mm	16mm
28Y	Y282113/BL	54.0mm	48.8mm	28mm	21mm	13mm
	Y282116/BL	54.0mm	48.8mm	28mm	21mm	16mm
	Y282121/BL	76.5mm	60.0mm	28mm	21mm	21mm
	Y282810/BL	67.3mm	55.9mm	28mm	28mm	10mm
	Y282813/BL	67.3mm	55.9mm	28mm	28mm	13mm
	Y282816/BL	67.3mm	55.9mm	28mm	28mm	16mm
	Y282821/BL	76.5mm	60.0mm	28mm	28mm	21mm
	Y282828/BL	90.7mm	67.0mm	28mm	28mm	28mm
34Y	Y343416/BL	100.6mm	75.0mm	34mm	34mm	16mm
	Y343421/BL	100.6mm	76.0mm	34mm	34mm	21mm
	Y343434/BL	100.6mm	82.1mm	34mm	34mm	34mm

Approvals



IP Rating

For use with: Type PA / PI / PR / PF

IP Rating	Appropriate Conduit
IP40	Yes
IP65	N/A
IP66	N/A
IP67	N/A
IP68	N/A
IP69K	N/A

Temperature Range

Static Applications: -40°C to +120°C

Moving Applications: -5°C to +120°C

Fitting Characteristics

Snap Fit

Non-metallic conduit systems

Type PK & A - Peek



Type PK
High Specification Conduit

Polyetherketone Type PK - Peek

High Specification Conduit / **Materials:** Polyetherketone / **Colour:** Black (BL) Only

Part No.	Nominal Conduit Size	NW Conduit Size	Conduit Pitch	Outside Diameter	Inside Diameter	Min. Bend Radius	Reel Length
PKFS13	13mm	10	Fine	13.2mm	10.0mm	35mm	25, 50m
PKFS16	16mm	13	Fine	16.3mm	11.7mm	45mm	25, 50m
PKFS21	21mm	17	Fine	21.2mm	16.6mm	60mm	25, 50m
PKCS28	28mm	23	Coarse	28.4mm	21.7mm	65mm	25, 50m
PKCS34	34mm	29	Coarse	34.3mm	27.7mm	80mm	25, 50m

To order quote part number, colour & reel length, e.g. PKFS16/BL/50M

Approvals



IP Rating	Appropriate Fitting	Temperature Range	UV Resistance
For use with: Peek Type A		Static Applications: -60°C to +260°C	Very High
IP40	N/A	Moving Applications: -45°C to +260°C	Flexibility & Fatigue Life High Flexibility - High Fatigue Life
IP65	N/A		
IP66	Peek Type A		Fire Performance & EMI Screen Self Extinguishing Halogen Free
IP67	Peek Type A		
IP68	N/A		
IP69K	N/A		



Type A
Straight Fitting

Type A - Peek

Straight Fitting - Fixed External Male Thread / For insertion into knockouts using a locknut

Materials: Nickel Plated Brass & Silicone

Part No.	Nominal Conduit Size	Metric Thread
PK13/M16/A	13mm	M16
PK16/M16/A	16mm	M16
PK21/M20/A	21mm	M20
PK28/M25/A	28mm	M25
PK34/M32/A	34mm	M32

Approvals



IP Rating	Appropriate Conduit	Temperature Range	Fire Performance & EMI Screen
For use with: Peek Type PK		Static Applications: -60°C to +260°C	
IP40	N/A	Moving Applications: -45°C to +260°C	
IP65	N/A		Fire Performance & EMI Screen
IP66	Yes		
IP67	Yes		
IP68	N/A		
IP69K	N/A		

Non-metallic conduit systems

Type PKTC & PKSS - Hi-Spec

2



Type PKTC
High Specification,
High EMI Screening Conduit

Type PKTC - Hi-Spec

High Specification, High EMI Screening Conduit

Materials: Polyetherketone Conduit, Tinned Copper Overbraid

Part No.	Nominal Conduit Size	NW Conduit Size	Conduit Pitch	Outside Diameter	Inside Diameter	Min. Bend Radius	Reel Length
PKFSTC13	13mm	10	Fine	14.1mm	10.0mm	35mm	25, 50m
PKFSTC16	16mm	13	Fine	17.2mm	11.7mm	45mm	25, 50m
PKFSTC21	21mm	17	Fine	23.6mm	16.6mm	60mm	25, 50m
PKCSTC28	28mm	23	Coarse	30.0mm	21.7mm	65mm	25, 50m
PKCSTC34	34mm	29	Coarse	36.0mm	27.7mm	80mm	25, 50m

To order quote part number & reel length, e.g. PKFSTC13/50M

Approvals



IP Rating	Appropriate Fitting	Temperature Range	UV Resistance
For use with: Hi-Spec Type A & B		Static Applications: -60°C to +260°C Moving Applications: -45°C to +260°C	Very High
IP40	N/A	Flexibility & Fatigue Life High Flexibility - High Fatigue Life	Fire Performance & EMI Screen Self Extinguishing Halogen Free
IP65	N/A		
IP66	Hi-Spec Type A & B		
IP67	Hi-Spec Type A & B		
IP68	N/A		
IP69K	N/A		

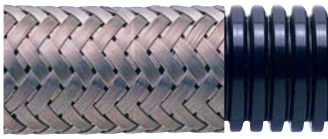

Type PKSS
High Specification,
Standard EMI Screening Conduit

Type PKSS - Hi-Spec

High Specification, Standard EMI Screening Conduit

Materials: Polyetherketone Conduit, Stainless Steel Overbraid

Part No.	Nominal Conduit Size	NW Conduit Size	Conduit Pitch	Outside Diameter	Inside Diameter	Min. Bend Radius	Reel Length
PKFSSS13	13mm	10	Fine	14.1mm	10.0mm	35mm	25, 50m
PKFSSS16	16mm	13	Fine	17.2mm	11.7mm	45mm	25, 50m
PKFSSS21	21mm	17	Fine	23.6mm	16.6mm	60mm	25, 50m
PKFSSS28	28mm	23	Coarse	30.0mm	21.7mm	65mm	25, 50m
PKFSSS34	34mm	29	Coarse	36.0mm	27.7mm	80mm	25, 50m

To order quote part number & reel length, e.g. PKFSSS13/50M

Approvals



IP Rating	Appropriate Fitting	Temperature Range	UV Resistance
For use with: Hi-Spec Type A & B		Static Applications: -60°C to +260°C Moving Applications: -45°C to +260°C	Very High
IP40	N/A	Flexibility & Fatigue Life High Flexibility - High Fatigue Life	Fire Performance & EMI Screen Self Extinguishing Halogen Free
IP65	N/A		
IP66	Hi-Spec Type A & B		
IP67	Hi-Spec Type A & B		
IP68	N/A		
IP69K	N/A		



Non-metallic conduit systems

Type PRTC & PRSS - Hi-Spec

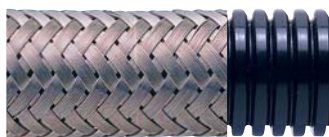

Type PRTC
High Specification,
High EMI Screening Conduit

Type PRTC - Hi-Spec

High Specification, High EMI Screening Conduit



Materials: PA (Nylon) 6 Conduit, Tinned Copper overbraid

Part No.	Nominal Conduit Size	NW Conduit Size	Conduit Pitch	Outside Diameter	Inside Diameter	Min. Bend Radius	Reel Length
PRFSTC16	16mm	13	Fine	17.2mm	11.7mm	35mm	50m
PRFSTC21	21mm	17	Fine	23.6mm	16.6mm	45mm	50m
PRCSTC28	28mm	23	Coarse	30.0mm	21.7mm	50mm	50m
PRCSTC34	34mm	29	Coarse	36.0mm	27.7mm	60mm	50m
PRCSTC42	42mm	36	Coarse	43.5mm	35.1mm	65mm	25m
PRCSTC54	54mm	48	Coarse	56.5mm	46.6mm	75mm	25m

To order quote part number, colour & reel length, e.g. PAFL13/BL/50M

Approvals



IP Rating	Appropriate Fitting	Temperature Range	UV Resistance
For use with: Hi-Spec Type A & B		Static Applications: -40°C to +120°C Moving Applications: -5°C to +120°C	Very High
IP40	N/A	Flexibility & Fatigue Life High Flexibility - Medium Fatigue Life	 
IP65	N/A		
IP66	Hi-Spec A & B	Fire Performance & EMI Screen Self Extinguishing	
IP67	Hi-Spec A & B		
IP68	N/A		
IP69K	N/A		

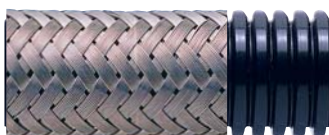

Type PRSS
High Specification,
Standard EMI Screening Conduit

Type PRSS - Hi-Spec

High Specification, Standard EMI Screening Conduit



Materials: PA (Nylon) 6 Conduit, Stainless Steel Overbraid

Part No.	Nominal Conduit Size	NW Conduit Size	Conduit Pitch	Outside Diameter	Inside Diameter	Min. Bend Radius	Reel Length
PRFSSS16	16mm	13	Fine	17.2mm	11.7mm	35mm	50m
PRFSSS21	21mm	17	Fine	23.6mm	16.6mm	45mm	50m
PRCSSS28	28mm	23	Coarse	30.0mm	21.7mm	50mm	50m
PRCSSS34	34mm	29	Coarse	36.0mm	27.7mm	60mm	50m
PRCSSS42	42mm	36	Coarse	43.5mm	35.1mm	65mm	25m
PRCSSS54	54mm	48	Coarse	56.5mm	46.6mm	75mm	25m

To order quote part number, colour & reel length, e.g. PRFSTC21/50M

Approvals



IP Rating	Appropriate Fitting	Temperature Range	UV Resistance
For use with: Hi-Spec Type A & B		Static Applications: -40°C to +120°C Moving Applications: -5°C to +120°C	Very High
IP40	N/A	Flexibility & Fatigue Life High Flexibility - Medium Fatigue Life	 
IP65	N/A		
IP66	Hi-Spec A & B	Fire Performance & EMI Screen Self Extinguishing	
IP67	Hi-Spec A & B		
IP68	N/A		
IP69K	N/A		

Non-metallic conduit systems

Type A & B - Hi-Spec

2



Type A
Straight Fitting

Type A - Hi-Spec

Straight Fitting - Fixed External Male Thread / For insertion into knockouts using a locknut

Materials: Nickel Plated Brass

Part No.	Nominal Conduit Size	Metric Thread
PBF13/M16/A	13mm	M16
PBF16/M16/A	16mm	M16
PBF21/M20/A	21mm	M20
PBC28/M25/A	28mm	M25
PBC34/M32/A	34mm	M32
PBC42/M40/A	42mm	M40

Approvals



IP Rating	Appropriate Conduit	Temperature Range
For use with: Hi-Spec Type PKTC / PKSS / PRTC / PRSS		
IP40	N/A	Static Applications: -60°C to +260°C Moving Applications: -45°C to +260°C
IP65	N/A	
IP66	Yes	
IP67	Yes	
IP68	N/A	
IP69K	N/A	
		Fire Performance & EMI Screen



Type B
Straight Fitting

Type B - Hi-Spec

Straight Fitting - Swivel External Male Thread / For insertion into threaded entries & knockouts

Materials: Nickel Plated Brass

Part No.	Nominal Conduit Size	Metric Thread
PBF13/M16/B	13mm	M16
PBF16/M16/B	16mm	M16
PBF21/M20/B	21mm	M20
PBC28/M25/B	28mm	M25
PBC34/M32/B	34mm	M32
PBC42/M40/B	42mm	M40
PBC54/M50/B	54mm	M50

Approvals



IP Rating	Appropriate Conduit	Temperature Range
For use with: Hi-Spec Type PKTC / PKSS / PRTC / PRSS		
IP40	N/A	Static Applications: -60°C to +260°C Moving Applications: -45°C to +260°C
IP65	N/A	
IP66	Yes	
IP67	Yes	
IP68	N/A	
IP69K	N/A	
		Fire Performance & EMI Screen

Metallic conduit systems

Conduit, fittings & accessories

Metallic Conduit Systems

Quick selection guide	3/2
Introduction	3/5

Adaptasteel Steel Conduit & Fittings

Type S - Galvanised Steel Conduit	3/6
Type SS - Stainless Steel Conduit	3/6
Type A - Nickel Plated Brass Fitting	3/7
Type B - Nickel Plated Brass Fitting	3/7
Type F - Nickel Plated Brass Fitting	3/8
Type C - Nickel Plated Brass Fitting	3/8

Adaptasteel Liquid Resistant Conduit & Fittings

Type SP - L/R General Purpose Conduit	3/9
Type SN - L/R Abrasion & Solvent Resistant Conduit	3/9
Type LFH-SP - L/R Enhanced Low Fire Hazard Conduit	3/10
Type A - Nickel Plated Brass Fitting	3/10
Type B - Nickel Plated Brass Fitting	3/11
Type C90 - Nickel Plated Steel Fitting	3/11
Type M - Nickel Plated Brass Fitting	3/12
Type F - Nickel Plated Brass Fitting	3/12
Type C - Nickel Plated Brass Fitting	3/13
Type E - Nickel Plated Brass Fitting	3/13

Adaptasteel Liquid Tight Conduit & Fittings

Type SPL - L/T Oil Resistant	3/14
Type LFH-SPL - L/T Low Fire Hazard	3/14
Type SPL-EF Enhanced Fire Performance NEW	3/15
Type SPLHC - L/T Extreme Temperature	3/16
Type SPUL - L/T UL Listed & CSA Approved	3/17
Type A - Nickel Plated Brass Fitting	3/17
Type B - Nickel Plated Brass Fitting	3/18
Type E - Nickel Plated Brass Fitting	3/18
Type M - Nickel Plated Brass Fitting	3/19
Type C90 - Nickel Plated Steel Fitting	3/20
Type 45 - Nickel Plated Brass Fitting	3/20

Adaptasteel Specialist EMI Screen Conduit & Fittings

Type SB - Specialist EMI Screen Conduit	3/21
Type STC - Specialist EMI Screen Conduit	3/21
Type SSB - Specialist EMI Screen Conduit	3/22
Type SSBGS - Specialist EMI Screen Conduit	3/22
Type A - Nickel Plated Brass Fitting	3/23
Type B - Nickel Plated Brass Fitting	3/23

Adaptasteel Specialist Liquid Resistant Conduit & Fittings

Type SPB - Specialist Liquid Resistant Conduit	3/24
Type SPTC - Specialist Liquid Resistant Conduit	3/24
Type A - Nickel Plated Brass Fitting	3/25
Type B - Nickel Plated Brass Fitting	3/25

Adaptasteel Specialist Liquid Tight Conduit & Fittings

Type SPLHCB - Specialist Liquid Tight Conduit	3/26
Type A - Nickel Plated Brass Fitting	3/26
Type B - Nickel Plated Brass Fitting	3/27

Metallic Accessories

Type LNB/LNS - Metallic Locknut	3/28
Type P - P-Clip Conduit Support	3/28
Type PSA - Proximity Switch Connectors	3/28
Type 90/45 - Brass Elbows	3/29
Type TC - UNEF Thread Converters	3/29
Female Coupler	3/29
Type E, R & TC - Enlargers, Reducers & Converters	3/30

Metallic conduit systems

Quick selection guide



3

Conduit Type	Type S	Type SS	Type SP	Type SN	Type LFH-SP	Type SPL	Type LFH-SPL	Type SPL-EF	Type SPLHC	Type SPUL
Part number	S	SS	SP	SN	LFH-SP	SPL	LFH-SPL	SPL-EF NEW	SPLHC	SPUL
Conduit material	Galvanised steel	Stainless steel	Galvanised steel	Galvanised steel	Galvanised steel	Galvanised steel	Galvanised steel	Galvanised steel	Galvanised steel	Galvanised steel
Covering/overbraid	-	-	PVC	PA (Nylon)	Polyolefin	PVC	Low fire hazard jacket	Thermoplastic jacket	Thermoplastic rubber	PVC

Conduit colour

Black (BL)	-	-	•	•	•	•	•	•	•	-
Grey (GR)	-	-	•	-	-	•	-	-	-	•

IP Rating (with appropriate fitting)

IP40	•	•	-	-	-	-	-	-	-	-
IP54	-	-	•	•	•	-	-	-	-	-
IP65	-	-	•	•	•	-	-	-	-	-
IP66	-	-	-	-	-	•	•	•	•	•
IP67	-	-	-	-	-	•	•	•	•	•
IP68	-	-	-	-	-	•	•	•	•	•
IP69k	-	-	-	-	-	•	•	•	•	•

Characteristics

Temperature Range

Static applications (°C)	-50 to +300	-50 to +350	-25 to +70	-25 to +90	-25 to +90	-20 to +105	-20 to +90	-40 to +105	-65 to +135	-20 to +75
Moving applications (°C)	-45 to +250	-45 to +250	-5 to +90	-5 to +105	-5 to +105	-5 to +105	-5 to +105	-30 to +105	-45 to +150	-5 to +105
UV resistance	Very high	Very high	Very high	High	High	Very high	High	Very high	Very high	High
Flexibility	High	High	High	Medium	High	Medium	Medium	Very high	Very high	Medium
Fatigue life	High	High	Medium	Medium	Medium	Medium	Medium	High	High	Medium
Low fire hazard	Inherent	Inherent	-	-	Enhanced	-	Enhanced	Enhanced	-	-
Halogen free	•	•	-	•	•	-	•	•	•	-
Self extinguishing	-	-	•	•	•	•	•	•	•	•
EMI screen	-	-	-	-	-	-	-	-	-	-
High mechanical strength	•	•	•	•	•	•	•	•	•	•
High abrasion resistance	-	•	-	-	-	-	-	-	-	-

Approvals

BSI Kitemark	•	•	•	•	•	•	•	•	•	•
CE	•	•	•	•	•	•	•	•	•	•
UL / CSA	-	-	-	-	-	-	-	-	-	•
UR	-	-	-	-	-	•	-	-	-	-
DB	-	-	-	-	-	-	-	-	-	-
NF F	-	-	-	-	•	-	•	-	-	-
Lloyds Register	-	-	-	-	•	•	-	-	-	-
LUL 1-085	-	-	-	-	•	-	•	-	-	-
UNI CEI 11170	-	-	-	-	-	-	-	-	-	-
EN45545-2 to HL3	-	-	-	-	-	-	•	•	-	-

Section 3 / Page No.	3/6	3/6	3/9	3/9	3/10	3/14	3/14	3/15	3/16	3/17
----------------------	-----	-----	-----	-----	------	------	------	------	------	------



Type SB	Type STC	Type SSB	Type SSBGS	Type SPB	Type SPTC	Type SPLHCB
SB	STC	SSB	SSBGS	SPB	SPTC	SPLHCB
Galvanised steel	Galvanised steel	Stainless steel	Galvanised steel	Galvanised steel	Galvanised steel	Galvanised steel
Galvanised steel	Tinned copper	Stainless steel	Stainless steel	PVC & Galvanised steel	PVC & tinned copper	Thermoplastic rubber & stainless steel
-	-	-	-	-	-	-
-	-	-	-	-	-	-
•	•	•	•	-	-	-
-	-	-	-	•	•	-
-	-	-	-	-	-	-
-	-	-	-	-	-	•
-	-	-	-	-	-	•
-	-	-	-	-	-	•
-	-	-	-	-	-	-
-50 to +300	-50 to +300	-50 to +300	-50 to +300	-15 to +70	-15 to +70	-65 to +135
-45 to +250	-45 to +250	-45 to +250	-45 to +250	-5 to +90	-5 to +90	-45 to +150
Very high	Very high	Very high	Very high	Very high	Very high	Very high
High	High	High	High	High	High	High
High	High	High	High	Medium	Medium	Medium
Inherent	Inherent	Inherent	Inherent	-	-	-
•	•	•	•	-	-	•
-	-	-	-	•	•	•
Enhanced	High	Standard	Standard	Enhanced	High	Standard
•	•	•	•	•	•	•
•	•	•	•	•	•	•
•	•	•	•	•	•	-
•	•	•	•	•	•	•
-	-	-	-	-	-	-
-	-	-	-	-	-	-
-	-	-	-	-	-	-
-	-	-	-	-	-	-
-	-	-	-	-	-	-
-	-	-	-	-	-	-
-	-	-	-	-	-	-
-	-	-	-	-	-	-
-	-	-	-	-	-	-
3/21	3/21	3/22	3/22	3/24	3/24	3/26



Metallic conduit systems

Introduction

Range overview

Adaptaflex have a wide selection of metallic conduits and metallic conduit systems manufactured either in galvanized steel or stainless steel.

A wide range of different conduit types provide a solution for liquid resistant specifications, with further conduit options in liquid tight covered steel conduit for especially demanding environments. Conduit ranges are offered in nominal conduit size from 3mm for CCTV/roller shutter doors and for protecting fibre optics cables right up to 75mm for larger cable carrying capacity.

Overbraided conduits are particularly suitable for installation in abrasive environments. Where applications call for enhanced low fire hazard properties or EMI screening then there is the option of high specification tinned copper overbraided for greater EMI protection levels.

In addition a range of fittings are specifically designed to maintain system integrity including fixed and swivel fittings, straights, 90°, 45°, and a host of accessories including locknuts, enlargers, reducers and converters.



Many of our conduit systems have industry recognised approvals including British Kitemark, CE Approval, UL 1696, NF, LUL, DB, Lloyd's Register amongst others.

Advantages:

- High compression/crush strength
- Tensile strength - pull off load under tension
- Impact resistance
- Inherent fire protection on uncoated versions
- Corrosion resistant - stainless steel options
- Braided - High level EMI screening with tinned copper overbraided



Metallic conduit systems

Type S & SS - Adaptasteel



Type S
Inherent Low Fire Hazard
Steel Conduit

3

Type S - Adaptasteel

Inherent Low Fire Hazard Steel Conduit / **Materials:** Galvanised Steel - General Purpose

Part No.	Nominal Conduit Size	Outside Diameter	Inside Diameter	Min. Bend Radius	Reel Length
S10	10mm	9.1mm	7.0mm	25mm	25, 50m
S12	12mm	13.0mm	10.3mm	30mm	10, 25, 50m
S16	16mm	16.0mm	13.0mm	35mm	10, 25, 50m
S20	20mm	20.5mm	16.9mm	45mm	10, 25, 50m
S25	25mm	25.0mm	21.4mm	55mm	10, 25, 50m
S32	32mm	32.0mm	28.1mm	60mm	10, 25m
S40	40mm	42.5mm	37.7mm	80mm	10, 25m
S50	50mm	53.0mm	48.4mm	90mm	10, 25m
S63	63mm	62.5mm	57.5mm	115mm	10m
S75	75mm	77.0mm	70.0mm	150mm	10m

To order quote part no, & reel length, e.g. S12/25M

Approvals



IP Rating	Appropriate Fitting	Temperature Range	UV Resistance
For use with: Type S		Static Applications: -50°C to +300°C	Very High
IP40	Type S - Type A, B, F & C	Moving Applications: -45°C to +250°C	
IP65	N/A	Flexibility & Fatigue Life	
IP66	N/A	High Flexibility - High Fatigue Life	
IP67	N/A	Fire Performance & EMI Screen	
IP68	N/A		
IP69K	N/A		



Type SS
Inherent Low Fire Hazard
Stainless Steel Conduit

Type SS - Adaptasteel

Inherent Low Fire Hazard Steel Conduit / **Materials:** Stainless Steel 316 - Corrosion Resistant

Part No.	Nominal Conduit Size	Outside Diameter	Inside Diameter	Min. Bend Radius	Reel Length
SS10	10mm	9.0mm	6.8mm	25mm	25, 50m
SS12	12mm	13.0mm	10.3mm	30mm	25, 50m
SS16	16mm	16.0mm	13mm	35mm	10, 25, 50m
SS20	20mm	20.5mm	16.9mm	45mm	10, 25, 50m
SS25	25mm	25.0mm	21.4mm	55mm	10, 25, 50m
SS32	32mm	32.0mm	28.1mm	60mm	10, 25m

To order quote part no, & reel length, e.g. SS12/25M

Approvals



IP Rating	Appropriate Fitting	Temperature Range	UV Resistance
For use with: Type S		Static Applications: -50°C to +350°C	Very High
IP40	Type S - Type A, B, F & C	Moving Applications: -45°C to +250°C	
IP65	N/A	Flexibility & Fatigue Life	
IP66	N/A	High Flexibility - High Fatigue Life	
IP67	N/A	Fire Performance & EMI Screen	
IP68	N/A		
IP69K	N/A		

Metallic conduit systems

Type A & B - Adaptasteel

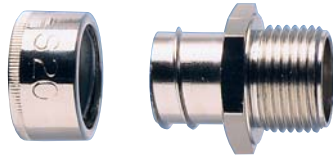

Type A
Straight Fitting

Type A - Adaptasteel

Straight Fitting - Fixed External Male Thread / For insertion into knockouts using a locknut (order locknut separately)

Materials: Nickel plated brass

Part No.	Nominal Conduit Size	Metric Thread	Part No.	Nominal Conduit Size	PG Thread
S10/M12/A	10mm	M12	S10/PG7/A	10mm	PG7
S12/M16/A	12mm	M16	S12/PG9/A	12mm	PG9
S16/M16/A	16mm	M16	S16/PG11/A	16mm	PG11
S16/M20/A	16mm	M20			
S20/M20/A	20mm	M20	S20/PG16/A	20mm	PG16
S25/M25/A	25mm	M25	S25/PG21/A	25mm	PG21
S32/M32/A	32mm	M32	S32/PG29/A	32mm	PG29
S40/M40/A	40mm	M40	S40/PG36/A	40mm	PG36
S50/M50/A	50mm	M50	S50/PG42/A	50mm	PG42
S63/M63/A	63mm	M63	S63/PG48/A	63mm	PG48
S75/M75/A	75mm	M75			

Approvals



IP Rating

Appropriate Conduit

For use with: Type S / SS

IP40	Yes
IP65	N/A
IP66	N/A
IP67	N/A
IP68	N/A
IP69K	N/A

Temperature Range

Static Applications: -50°C to +300°C

Moving Applications: -45°C to +250°C



Type B
Straight Fitting

Type B - Adaptasteel

Straight Fitting - Swivel External Male Thread / For insertion into threaded entries & knockouts using a locknut (order locknut separately)

Materials: Nickel plated brass

Part No.	Nominal Conduit Size	Metric Thread	Part No.	Nominal Conduit Size	PG Thread
S10/M12/B	10mm	M12	S10/PG7/B	10mm	PG7
S12/M16/B	12mm	M16	S12/PG9/B	12mm	PG9
S16/M16/B	16mm	M16	S16/PG11/B	16mm	PG11
S16/M20/B	16mm	M20			
S20/M20/B	20mm	M20	S20/PG16/B	20mm	PG16
S25/M25/B	25mm	M25	S25/PG21/B	25mm	PG21
S32/M32/B	32mm	M32	S32/PG29/B	32mm	PG29
S40/M40/B	40mm	M40	S40/PG36/B	40mm	PG36
S50/M50/B	50mm	M50	S50/PG42/B	50mm	PG42

Approvals



IP Rating

Appropriate Conduit

For use with: Type S / SS

IP40	Yes
IP65	N/A
IP66	N/A
IP67	N/A
IP68	N/A
IP69K	N/A

Temperature Range

Static Applications: -50°C to +300°C

Moving Applications: -45°C to +250°C

Fitting Characteristics



Metallic conduit systems

Type F & C - Adaptasteel



Type F
Straight Fitting

Type F - Adaptasteel

Straight Fitting - Fixed Internal Female Thread / For attaching to external threads & other fittings

Materials: Nickel plated brass

Part No.	Nominal Conduit Size	Metric Thread
S20/M20/F	20mm	M20
S25/M25/F	25mm	M25
S32/M32/F	32mm	M32

Approvals



IP Rating	Appropriate Conduit	Temperature Range
For use with: Type S / SS		Static Applications: -50°C to +300°C
IP40	Yes	Moving Applications: -45°C to +250°C
IP65	N/A	
IP66	N/A	
IP67	N/A	
IP68	N/A	
IP69K	N/A	



Type C
Smooth Entry Bush

Type C - Adaptasteel

Smooth Entry Bush / For locking conduit into plain holes in enclosures

Materials: Nickel plated brass

Part No.	Nominal Conduit Size	Hole Size
S10/9/C	10mm	9mm
S12/12/C	12mm	12mm
S16/16/C	16mm	16mm
S20/20/C	20mm	20mm
S25/25/C	25mm	25mm
S32/32/C	32mm	32mm
S40/40/C	40mm	40mm
S50/51/C	50mm	51mm
S63/61/C	63mm	61mm
S75/75/C	75mm	75mm

Approvals



IP Rating	Appropriate Conduit	Temperature Range
For use with: Type S / SS		Static Applications: -50°C to +300°C
IP40	Yes	Moving Applications: -45°C to +250°C
IP65	N/A	
IP66	N/A	
IP67	N/A	
IP68	N/A	
IP69K	N/A	

Metallic conduit systems

Type SP & SN - Adaptasteel



Type SP
Liquid Resistant General Purpose
Covered Steel Flexible Conduit

Type SP - Adaptasteel

Liquid Resistant General Purpose Covered Steel Flexible Conduit

Materials: PVC Covered Galvanised Steel / **Colour:** Black (BL), Grey (GR), Orange (OR)

Part No.	Nominal Conduit Size	Outside Diameter	Inside Diameter	Min. Bend Radius	Reel Length
SP10	10mm	10.0mm	6.8mm	25mm	25, 50m
SP12	12mm	14.0mm	10.3mm	30mm	25, 50m
SP16	16mm	17.0mm	13.0mm	35mm	10, 25, 50m
SP20	20mm	21.5mm	16.9mm	45mm	10, 25, 50m
SP25	25mm	26.0mm	21.4mm	55mm	10, 25, 50m
SP32	32mm	34.0mm	28.1mm	60mm	10, 25m
SP40	40mm	44.5mm	37.7mm	80mm	10, 25m
SP50	50mm	55.0mm	48.4mm	90mm	10, 25m
SP63	63mm	64.5mm	57.5mm	115mm	10m
SP75	75mm	79.0mm	70.0mm	150mm	10m

To order quote part no, colour & reel length, e.g. SP12/BL/25M

Approvals



IP Rating	Appropriate Fitting	Temperature Range	UV Resistance
For use with: Type SP		Static Applications: -25°C to +70°C	Very High
IP40	Type SP - Type A, B, C, E & F	Moving Applications: -5°C to +90°C	
IP65	Type SP - Type M & C90	Flexibility & Fatigue Life	
IP66	N/A	High Flexibility - Medium Fatigue Life	
IP67	N/A	Fire Performance & EMI Screen	
IP68	N/A	Self Extinguishing	
IP69K	N/A		



Type SN
Liquid Resistant Abrasion
& Solvent Resistant Covered
Steel Flexible Conduit

Type SN - Adaptasteel

Liquid Resistant Abrasion & Solvent Resistant Covered Steel Flexible Conduit

Materials: PA (Nylon) Covered Galvanised Steel / **Colour:** Black (BL) Only

Part No.	Nominal Conduit Size	Outside Diameter	Inside Diameter	Min. Bend Radius	Reel Length
SN12	12mm	14.0mm	10.3mm	30mm	25, 50m
SN16	16mm	17.0mm	13.0mm	35mm	25, 50m
SN20	20mm	21.5mm	16.9mm	45mm	25, 50m
SN25	25mm	26.0mm	21.4mm	55mm	25, 50m
SN32	32mm	34.0mm	28.1mm	60mm	25m

To order quote part no, colour & reel length, e.g. SN12/BL/25M

Approvals



IP Rating	Appropriate Fitting	Temperature Range	UV Resistance
For use with: Type SP		Static Applications: -40°C to +120°C	High
IP40	Type SP - Type A, B, C, E & F	Moving Applications: -25°C to +150°C	
IP65	Type SP - Type M & C90	Flexibility & Fatigue Life	
IP66	N/A	Medium Flexibility - Medium Fatigue Life	
IP67	N/A	Fire Performance & EMI Screen	
IP68	N/A	Self Extinguishing	
IP69K	N/A	Halogen Free	

Metallic conduit systems

Type LFH-SP & A - Adaptasteel



Type LFH-SP
Liquid Resistant Enhanced
Low Fire Hazard Covered
Steel Flexible Conduit

3

Type LFH-SP - Adaptasteel

Liquid Resistant Enhanced Low Fire Hazard Covered Steel Flexible Conduit

Materials: Polyolefin Covered Galvanised Steel / Colour: Black (BL) Only

Part No.	Nominal Conduit Size	Outside Diameter	Inside Diameter	Min. Bend Radius	Reel Length
LFH-SP12	12mm	14.0mm	10.3mm	30mm	25, 50m
LFH-SP16	16mm	17.0mm	13.0mm	35mm	10, 25, 50m
LFH-SP20	20mm	21.5mm	16.9mm	45mm	10, 25, 50m
LFH-SP25	25mm	26.0mm	21.4mm	55mm	10, 25, 50m
LFH-SP32	32mm	34.0mm	28.1mm	60mm	10, 25m
LFH-SP40	40mm	44.5mm	37.7mm	80mm	10, 25m
LFH-SP50	50mm	55.0mm	48.4mm	90mm	10, 25m
LFH-SP63	63mm	64.5mm	57.5mm	115mm	10m
LFH-SP75	75mm	79.0mm	70.0mm	150mm	10m

To order quote part number, colour & reel length, e.g. LFH-SP16/BL/50M

Approvals



EN45545-2 HL3 - R22 & R23

IP Rating	Appropriate Fitting	Temperature Range	UV Resistance
For use with: Type SP		Static Applications: -25°C to +90°C	High
IP54	Type SP - Type A, B, C, E & F	Moving Applications: -5°C to +105°C	
IP65	Type SP - Type M & C90	Flexibility & Fatigue Life	
IP66	N/A	Medium Flexibility - Medium Fatigue Life	
IP67	N/A	Fire Performance & EMI Screen	
IP68	N/A	Self Extinguishing	
IP69K	N/A	Halogen Free	

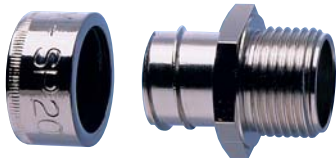

Type A
Straight Fitting

Type A - Adaptasteel

Straight Fitting - Fixed External Male Thread / For insertion into knockouts using a locknut (order locknut separately)

Materials: Nickel plated brass

Part No.	Nominal Conduit Size	Metric Thread	Part No.	Nominal Conduit Size	PG Thread
SP10/M12/A	10mm	M12	SP10/PG7/A	10mm	PG7
SP12/M16/A	12mm	M16	SP12/PG9/A	12mm	PG9
SP16/M16/A	16mm	M16			
SP16/M20/A	16mm	M20	SP16/PG11/A	16mm	PG11
SP20/M20/A	20mm	M20	SP20/PG16/A	20mm	PG16
SP25/M25/A	25mm	M25	SP25/PG21/A	25mm	PG21
SP32/M32/A	32mm	M32	SP32/PG29/A	32mm	PG29
SP40/M40/A	40mm	M40	SP40/PG36/A	40mm	PG36
SP50/M50/A	50mm	M50	SP50/PG42/A	50mm	PG42
SP63/M63/A	63mm	M63	SP63/PG48/A	63mm	PG48
SP75/M75/A	75mm	M75			

Approvals



IP Rating	Appropriate Conduit	Temperature Range
For use with: Type SP / SN / LFH-SP		Static Applications: -50°C to +300°C
IP54	Yes	Moving Applications: -45°C to +250°C
IP65	N/A	
IP66	N/A	
IP67	N/A	
IP68	N/A	
IP69K	N/A	

Metallic conduit systems

Type B & C90 - Adaptasteel

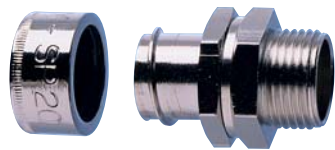

Type B
Straight Fitting

Type B - Adaptasteel

Straight Fitting - Swivel External Thread / For insertion into threaded entries & knockouts using a locknut (order locknut separately)

Materials: Nickel plated brass

Part No.	Nominal Conduit Size	Metric Thread	Part No.	Nominal Conduit Size	PG Thread
SP10/M12/B	10mm	M12	SP10/PG7/B	10mm	PG7
SP12/M16/B	12mm	M16	SP12/PG9/B	12mm	PG9
SP16/M16/B	16mm	M16	SP16/PG11/B	16mm	PG11
SP16/M20/B	16mm	M20			
SP20/M20/B	20mm	M20	SP20/PG16/B	20mm	PG16
SP25/M25/B	25mm	M25	SP25/PG21/B	25mm	PG21
SP32/M32/B	32mm	M32	SP32/PG29/B	32mm	PG29
SP40/M40/B	40mm	M40	SP40/PG36/B	40mm	PG36
SP50/M50/B	50mm	M50	SP50/PG42/B	50mm	PG42

Approvals



IP Rating

Appropriate Conduit

For use with: Type SP / SN / LFH-SP

IP54	Yes
IP65	N/A
IP66	N/A
IP67	N/A
IP68	N/A
IP69K	N/A

Temperature Range

Static Applications: -50°C to +300°C

Moving Applications: -45°C to +250°C

Fitting Characteristics



Type C90
90° Combined Fitting & Elbow

Type C90 - Adaptasteel

90° Combined Fitting & Elbow / For insertion into threaded entries & knockouts using a locknut (order locknut separately)

Materials: Nickel plated brass

Part No.	Nominal Conduit Size	Metric Thread
SP16/M16/C90	16mm	M16
SP16/M20/C90	16mm	M20
SP20/M20/C90	20mm	M20
SP25/M25/C90	25mm	M25
SP32/M32/C90	32mm	M32

Approvals



IP Rating

Appropriate Conduit

For use with: Type SP / SN / LFH-SP

IP54	N/A
IP65	Yes
IP66	N/A
IP67	N/A
IP68	N/A
IP69K	N/A

Temperature Range

Static Applications: -50°C to +300°C

Moving Applications: -45°C to +250°C

Fitting Characteristics



Metallic conduit systems

Type M & F - Adaptasteel

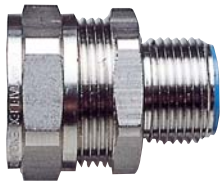

3

Type M
Straight Swivel Fitting

Type M - Adaptasteel

Straight Swivel Fitting - External Male Thread / For insertion into threaded entries & knockouts using a locknut (order locknut separately)

Materials: Nickel plated brass

Part No.	Nominal Conduit Size	Metric Thread	Part No.	Nominal Conduit Size	PG Thread
SP12/M16/M	12mm	M16	SP12/PG9/M	12mm	PG9
SP16/M16/M	16mm	M16	SP16/PG11/M	16mm	PG11
SP16/M20/M	16mm	M20	SP16/PG13/M	16mm	PG13,5
SP20/M20/M	20mm	M20	SP20/PG16/M	20mm	PG16
SP25/M25/M	25mm	M25	SP25/PG21/M	25mm	PG21
SP32/M32/M	32mm	M32	SP32/PG29/M	32mm	PG29
SP40/M40/M	40mm	M40			
SP50/M50/M	50mm	M50			

Part No.	Nominal Conduit Size	NPT Thread
SP16/038/M	16mm	3/8"
SP20/050/M	20mm	1/2"
SP25/075/M	25mm	3/4"
SP32/100/M	32mm	1"

Approvals



IP Rating	Appropriate Conduit	Temperature Range
For use with: Type SP / SN / LFH-SP		Static Applications: -50°C to +150°C Moving Applications: -45°C to +150°C
IP54	N/A	Fitting Characteristics 
IP65	Yes	
IP66	N/A	
IP67	N/A	
IP68	N/A	
IP69K	N/A	



Type F
Straight Fitting

Type F - Adaptasteel

Straight Fitting - Fixed Internal Female Thread / For external threads and other fittings

Materials: Nickel plated brass

Part No.	Nominal Conduit Size	Metric Thread
SP20/M20/F	20mm	M20
SP25/M25/F	25mm	M25
SP32/M32/F	32mm	M32

Approvals



IP Rating	Appropriate Conduit	Temperature Range
For use with: Type SP / SN / LFH-SP		Static Applications: -50°C to +300°C Moving Applications: -45°C to +250°C
IP54	Yes	Fitting Characteristics 
IP65	N/A	
IP66	N/A	
IP67	N/A	
IP68	N/A	
IP69K	N/A	

Metallic conduit systems

Type C & E - Adaptasteel



Type C
Smooth Entry Bush

Type C - Adaptasteel

Smooth Entry Bush / For locking conduit into plain holes in enclosures

Materials: Nickel plated brass

Part No.	Nominal Conduit Size	Hole Size
SP10/9/C	10mm	9mm
SP12/12/C	12mm	12mm
SP16/16/C	16mm	16mm
SP20/20/C	20mm	20mm
SP25/25/C	25mm	25mm
SP32/32/C	32mm	32mm
SP40/40/C	40mm	40mm
SP50/51/C	50mm	51mm
SP63/61/C	63mm	61mm
SP75/75/C	75mm	75mm

Approvals



IP Rating	Appropriate Conduit	Temperature Range
For use with: Type SP / SN / LFH-SP		
IP54	Yes	Static Applications: -50°C to +300°C Moving Applications: -45°C to +250°C
IP65	N/A	
IP66	N/A	
IP67	N/A	
IP68	N/A	
IP69K	N/A	



Type E
Conduit Terminator

Type E - Adaptasteel

Conduit Terminator / Cable Protection at exit point

Materials: Nickel plated brass

Part No.	Nominal Conduit Size
SP12/E	12mm
SP16/E	16mm
SP20/E	20mm
SP25/E	25mm
SP32/E	32mm
SP40/E	40mm
SP50/E	50mm

Approvals



IP Rating	Appropriate Conduit	Temperature Range
For use with: Type SP / SN / LFH-SP		
IP54	Yes	Static Applications: -50°C to +300°C Moving Applications: -45°C to +250°C
IP65	N/A	
IP66	N/A	
IP67	N/A	
IP68	N/A	
IP69K	N/A	

Metallic conduit systems

Type SPL & LFH-SPL - Adaptasteel

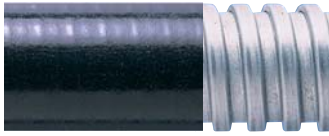

Type SPL
Liquid Tight Oil Resistant
Covered Steel Flexible Conduit

Type SPL - Adaptasteel

Liquid Tight Oil Resistant Covered Steel Flexible Conduit

Materials: PVC Covered Galvanised Steel / **Colour:** Black (BL), Grey (GR), Orange (OR)

Part No.	Nominal Conduit Size	Outside Diameter	US Conduit Size	Inside Diameter	Min. Bend Radius	Reel Length
SPL10	10mm	11.8mm	1/4"	7.0mm	40mm	10, 25, 50m
SPL12	12mm	14.2mm	5/16"	10.0mm	45mm	10, 25, 50m
SPL16	16mm	17.8mm	3/8"	12.5mm	50mm	10, 25, 50m
SPL20	20mm	21.1mm	1/2"	15.9mm	80mm	10, 25, 50m
SPL25	25mm	26.4mm	3/4"	21.0mm	110mm	10, 25, 50m
SPL32	32mm	33.1mm	1"	26.7mm	145mm	10, 25m
SPL40	40mm	41.8mm	1 1/4"	35.4mm	180mm	10, 25m
SPL50	50mm	47.9mm	1 1/2"	40.4mm	240mm	10, 25m
SPL63	63mm	59.7mm	2"	51.6mm	345mm	10, 25m

To order quote part number, colour & reel length, e.g. SPL12/BL/50M

Approvals



IP Rating	Appropriate Fitting	Temperature Range	UV Resistance
For use with: Type SPL		Static Applications: -20°C to +105°C	Very High
IP40	N/A	Moving Applications: -5°C to +105°C	
IP65	N/A	Flexibility & Fatigue Life	
IP66	Type SPL - Type M, C45 & C90	Medium Flexibility - Medium Fatigue Life	
IP67	Type SPL - Type A, B, M, C45 & C90	Fire Performance & EMI Screen	
IP68	Type SPL - Type M, C45 & C90 (10 bar 30 mins)	Self Extinguishing	
IP69K	Type SPL - Type M, C45 & C90		

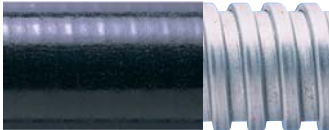

Type LFH-SPL
Low Fire Hazard Performance
Covered Steel Flexible Conduit

Type LFH-SPL - Adaptasteel

Low Fire Hazard Performance Covered Steel Flexible Conduit

Materials: Low Fire Hazard Jacket Covered Galvanised Steel / **Colour:** Black (BL) Only

Part No.	Nominal Conduit Size	Outside Diameter	US Conduit Size	Inside Diameter	Min. Bend Radius	Reel Length
LFH-SPL16	16mm	17.0mm	3/8"	13.0mm	50mm	10, 25m
LFH-SPL20	20mm	21.5mm	1/2"	16.9mm	80mm	10, 25m
LFH-SPL25	25mm	26.0mm	3/4"	21.4mm	110mm	10, 25m
LFH-SPL32	32mm	34.0mm	1"	28.1mm	145mm	10, 25m
LFH-SPL40	40mm	44.5mm	1 1/4"	37.7mm	180mm	10m
LFH-SPL50	50mm	55.0mm	1 1/2"	48.4mm	240mm	10m
LFH-SPL63	63mm	64.5mm	2"	57.5mm	345mm	10m

To order quote part number, colour & reel length, e.g. LFH-SPL16/BL/25M

Approvals



EN45545-2 HL3 - R22 & R23

IP Rating	Appropriate Fitting	Temperature Range	UV Resistance
For use with: Type SPL		Static Applications: -20°C to +90°C	High
IP40	N/A	Moving Applications: -5°C to +105°C	
IP65	N/A	Flexibility & Fatigue Life	
IP66	Type SPL - Type M, C45 & C90	Medium Flexibility - Medium Fatigue Life	
IP67	Type SPL - Type A, B, M, C45 & C90	Fire Performance & EMI Screen	
IP68	Type SPL - Type M, C45 & C90 (10 bar 30 mins)	Self Extinguishing	
IP69K	Type SPL - Type M, C45 & C90	Halogen Free	



Metallic conduit systems

Type SPL-EF - Adaptasteel

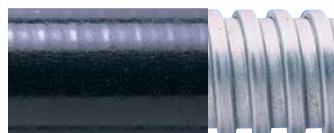

Type SPL-EF
Enhanced Fire Performance
Covered Steel Flexible Conduit

The **NEW SPL-EF** conduit systems are **Enhanced Fire Performance** rated, highly flexible, liquid tight with a wide temperature operating range.

Designed to meet the demand for 'interoperability' and compliance with stringent local and European fire safety requirements in the rail infrastructure market, the SPL-EF system, is accredited with the EN45545-2 standard achieving the highest HL3 fire performance rating for both interior and exterior locations.

The system provides higher performance levels of flexibility, impact and abrasion resistance, combined with enhanced chemical resistances especially to oils and greases, with a much higher and lower temperature rating (-40°C to +105°C), than any other metallic conduit system with a EN45545-2 HL3 rating.

Advantages include:

- EN45545-2 and BS EN 61386-1 & 23 accreditation
- HL3 - R22 & R23 rating
- Up to IP69K rating
- High flexibility
- Oil and hydrocarbons resistant
- Suitable for wide use underground and in any part of train vehicles and infrastructure

Type SPL-EF - Adaptasteel **NEW**

Enhanced Fire Performance Covered Steel Flexible Conduit

Materials: Thermoplastic Jacket Covered Galvanised Steel / **Colour:** Black (BL) Only

Part No.	Nominal Conduit Size	Outside Diameter	US Conduit Size	Inside Diameter	Min. Bend Radius	Reel Length
SPL-EF12	12mm	14.2mm	5/16"	12.0mm	45mm	10, 25, 50m
SPL-EF16	16mm	17.8mm	3/8"	12.5mm	50mm	10, 25, 50m
SPL-EF20	20mm	21.1mm	1/2"	15.9mm	80mm	10, 25, 50m
SPL-EF25	25mm	26.4mm	3/4"	21.0mm	110mm	10, 25, 50m
SPL-EF32	32mm	33.1mm	1"	26.7mm	145mm	10, 25, 50m
SPL-EF40	40mm	41.8mm	1 1/4"	35.4mm	180mm	10, 25m
SPL-EF50	50mm	47.9mm	1 1/2"	40.4mm	240mm	10, 25m

To order quote part number, colour & reel length, e.g. SPL-EF12/BL/50M

Approvals



EN45545-2 HL3 - R22 & R23

IP Rating	Appropriate Fitting	Temperature Range	UV Resistance
For use with: Type SPL		Static Applications: -40°C to +105°C	Very High
IP40	N/A	Moving Applications: -30°C to +105°C	
IP65	N/A	Flexibility & Fatigue Life	
IP66	Type SPL - Type M, C45 & C90	Very High Flexibility - High Fatigue Life	
IP67	Type SPL - Type A, B, M, C45 & C90	Fire Performance & EMI Screen	
IP68	Type SPL - Type M, C45 & C90 (10 bar 30 mins)	Self Extinguishing	
IP69K	Type SPL - Type M, C45 & C90	Halogen Free	



Metallic conduit systems

Type SPLHC - Adaptasteel

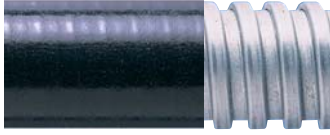

Type SPLHC
Liquid Tight Extreme Temperature
Covered Steel Flexible Conduit

3

Type SPLHC - Adaptasteel

Liquid Tight Extreme Temperature Covered Steel Flexible Conduit

Materials: Thermoplastic Rubber Covered Galvanised Steel / **Colour:** Black (BL) Only

Part No.	Nominal Conduit Size	Outside Diameter	US Conduit Size	Inside Diameter	Min. Bend Radius	Reel Length
SPLHC10	10mm	11.8mm	1/4"	7.0mm	40mm	25, 50m
SPLHC12	12mm	14.2mm	5/16"	10.0mm	40mm	25, 50m
SPLHC16	16mm	17.8mm	3/8"	12.5mm	50mm	25m
SPLHC20	20mm	21.1mm	1/2"	15.9mm	80mm	25m
SPLHC25	25mm	26.4mm	3/4"	21.0mm	110mm	25m
SPLHC32	32mm	33.1mm	1"	26.7mm	145mm	25m
SPLHC40	40mm	41.8mm	1 1/4"	35.4mm	180mm	25m
SPLHC50	50mm	47.9mm	1 1/2"	40.4mm	240mm	25m
SPLHC63	63mm	59.7mm	2"	51.6mm	345mm	25m

To order quote part number, colour & reel length, e.g. SPLHC12/BL/50M

Approvals



IP Rating	Appropriate Fitting	Temperature Range	UV Resistance
For use with: Type SPL		Static Applications: -65°C to +135°C	Very High
IP40	N/A	Moving Applications: -45°C to +150°C	
IP65	N/A	Flexibility & Fatigue Life	
IP66	Type SPL - Type M, C45 & C90	Very High Flexibility - High Fatigue Life	
IP67	Type SPL - Type A, B, M, C45 & C90	Fire Performance & EMI Screen	
IP68	Type SPL - Type M, C45 & C90 (10 bar 30 mins)	Self Extinguishing	
IP69K	Type SPL - Type M, C45 & C90	Halogen Free	

Metallic conduit systems

Type SPUL & A - Adaptasteel



Type SPUL
Covered Steel Flexible Conduit

Type SPUL - Adaptasteel

Liquid Tight UL Listed & CSA Approved Covered Steel Flexible Conduit

Materials: PVC Covered Galvanised Steel with Copper Packing / **Colour:** Black (BL), Grey (GR)

Part No.	Nominal Conduit Size	Outside Diameter	US Conduit Size	Inside Diameter	Min. Bend Radius	Reel Length
SPUL16	16mm	17.8mm	3/8"	12.5mm	50mm	25, 50m
SPUL20	20mm	21.1mm	1/2"	15.9mm	80mm	50m
SPUL25	25mm	26.4mm	3/4"	21.0mm	110mm	25, 50m
SPUL32	32mm	33.1mm	1"	26.7mm	145mm	25m
SPUL40	40mm	41.8mm	1 1/4"	35.4mm	180mm	25m
SPUL50	50mm	47.9mm	1 1/2"	40.4mm	240mm	25m
SPUL63	63mm	59.7mm	2"	51.6mm	345mm	10, 25m

To order quote part number, colour & reel length, e.g. SPUL16/BL/25M

Approvals

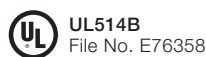

IP Rating	Appropriate Fitting	Temperature Range	UV Resistance
For use with: Type SPL		Static Applications: -20°C to +75°C	High
IP40	N/A	Moving Applications: -5°C to +105°C	
IP65	N/A	Flexibility & Fatigue Life	
IP66	Type SPL - Type M, C45 & C90	Medium Flexibility - Medium Fatigue Life	
IP67	Type SPL - Type A, B, M, C45 & C90	Fire Performance & EMI Screen	
IP68	Type SPL - Type M, C45 & C90 (10 bar 30 mins)	Self Extinguishing	
IP69K	Type SPL - Type M, C45 & C90		



Type A
Straight Fitting

Type A - Adaptasteel

Straight Fitting - Fixed External Male Thread / For insertion into threaded entries & knockouts using a locknut (order locknut separately)

Materials: Nickel plated brass

Part No.	Nominal Conduit Size	US Conduit Size	Metric Thread
SPL16/M16/A	16mm	3/8"	M16
SPL16/M20/A	16mm	3/8"	M20
SPL20/M20/A	20mm	1/2"	M20
SPL25/M25/A	25mm	3/4"	M25
SPL32/M32/A	32mm	1"	M32

Approvals



IP Rating	Appropriate Conduit	Temperature Range
For use with: Type SPL / SPLHC / SPUL / SPL-EF / LFH-SPL		Static Applications: -65°C to +150°C
IP40	N/A	Moving Applications: -45°C to +150°C
IP65	N/A	
IP66	N/A	
IP67	Yes	
IP68	N/A	
IP69K	N/A	

Metallic conduit systems

Type B & E - Adaptasteel

3



Type B
Straight Fitting

Type B - Adaptasteel

Straight Fitting - Swivel External Male Thread / For insertion into threaded entries & knockouts using a locknut (order locknut separately)

Materials: Nickel plated brass

Part No.	Nominal Conduit Size	US Conduit Size	Metric Thread
SPL16/M16/B	16mm	3/8"	M16
SPL16/M20/B	16mm	3/8"	M20
SPL20/M20/B	20mm	1/2"	M20
SPL25/M25/B	25mm	3/4"	M25
SPL32/M32/B	32mm	1"	M32

Approvals



IP Rating

Appropriate Conduit

Temperature Range

For use with: Type SPL / SPLHC / SPUL / SPL-EF / LFH-SPL

Static Applications: -65°C to +150°C

IP54	N/A
IP65	N/A
IP66	N/A
IP67	Yes
IP68	N/A
IP69K	N/A

Moving Applications: -45°C to +150°C

Fitting Characteristics



Type E
Conduit Terminator

Type E - Adaptasteel

Conduit Terminator / Cable protection at exit point

Materials: Nickel plated brass

Part No.	Nominal Conduit Size	US Conduit Size
SPL10/E	10mm	1/4"
SPL12/E	12mm	5/16"
SPL16/E	16mm	3/8"
SPL20/E	20mm	1/2"
SPL25/E	25mm	3/4"
SPL32/E	32mm	1"
SPL40/E	40mm	1 1/4"
SPL50/E	50mm	1 1/2"
SPL63/E	63mm	2"

Approvals



IP Rating

Appropriate Conduit

Temperature Range

For use with: Type SPL / SPLHC / SPUL / SPL-EF / LFH-SPL

Static Applications: -65°C to +300°C

IP54	Yes
IP65	N/A
IP66	N/A
IP67	N/A
IP68	N/A
IP69K	N/A

Moving Applications: -45°C to +250°C

Metallic conduit systems

Type M - Adaptasteel

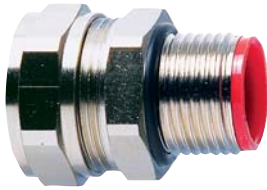

Type M
Straight Swivel Fitting

Type M - Adaptasteel

Straight Swivel Fitting - External Male Thread / For insertion into threaded entries & knockouts using a locknut (order locknut separately)

Materials: Nickel plated brass

Part No.	Nominal Conduit Size	US Conduit Size	Metric Thread
SPL10/M12/M	10mm	1/4"	M12
SPL12/M16/M	12mm	5/16"	M16
SPL16/M16/M	16mm	3/8"	M16
SPL16/M20/M	16mm	3/8"	M20
SPL20/M20/M	20mm	1/2"	M20
SPL25/M25/M	25mm	3/4"	M25
SPL32/M32/M	32mm	1"	M32
SPL40/M40/M	40mm	1 1/4"	M40
SPL50/M50/M	50mm	1 1/2"	M50
SPL63/M63/M	63mm	2"	M63

Part No.	Nominal Conduit Size	US Conduit Size	PG Thread
SPL10/PG7/M	10mm	1/4"	PG7
SPL12/PG9/M	12mm	5/16"	PG9
SPL16/PG11/M	16mm	3/8"	PG11
SPL16/PG13/M	16mm	3/8"	PG13,5
SPL20/PG16/M	20mm	1/2"	PG16
SPL25/PG21/M	25mm	3/4"	PG21
SPL32/PG29/M	32mm	1"	PG29
SPL40/PG36/M	40mm	1 1/4"	PG36
SPL50/PG42/M	50mm	1 1/2"	PG42
SPL63/PG48/M	63mm	2"	PG48

Part No.	Nominal Conduit Size	US Conduit Size	NPT Thread
SPL16/038/M	16mm	3/8"	3/8"
SPL20/050/M	20mm	1/2"	1/2"
SPL25/075/M	25mm	3/4"	3/4"
SPL32/100/M	32mm	1"	1"
SPL40/125/M	40mm	1 1/4"	1 1/4"
SPL50/150/M	50mm	1 1/2"	1 1/2"

Approvals



UL514B
File No. E60625

IP Rating

Appropriate Conduit

For use with: Type SPL / SPLHC / SPUL / SPL-EF / LFH-SPL

IP54	N/A
IP65	N/A
IP66	Yes
IP67	Yes
IP68	Yes (10 bar 30mins)
IP69K	Yes

Temperature Range

Static Applications: -65°C to +150°C

Moving Applications: -45°C to +150°C

Fitting Characteristics



Metallic conduit systems

Type C90 & 45 - Adaptasteel

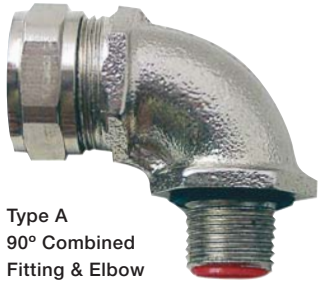

3 Type A
90° Combined
Fitting & Elbow

Type C90 - Adaptasteel

90° Combined Fitting & Elbow - Swivel External Male Thread / For insertion into threaded entries & knockouts using a locknut

(order locknut separately)

Materials: Nickel plated brass

Part No.	Nominal Conduit Size	US Conduit Size	Metric Thread	Part No.	Nominal Conduit Size	US Conduit Size	NPT Thread
SPL16/M16/C90	16mm	3/8"	M16	SPL16/038/C90	16mm	3/8"	3/8"
SPL16/M20/C90	16mm	3/8"	M20	SPL16/050/C90	16mm	3/8"	3/8"
SPL20/M20/C90	20mm	1/2"	M20	SPL20/050/C90	20mm	1/2"	1/2"
SPL25/M25/C90	25mm	3/4"	M25	SPL25/075/C90	25mm	3/4"	3/4"
SPL32/M32/C90	32mm	1"	M32	SPL32/100/C90	32mm	1"	1"
SPL40/M40/C90	40mm	1 1/4"	M40	SPL40/125/C90	40mm	1 1/4"	1 1/4"
SPL50/M50/C90	50mm	1 1/2"	M50	SPL50/150/C90	50mm	1 1/2"	1 1/2"
SPL63/M63/C90	63mm	2"	M63	SPL63/200/C90	63mm	2"	2"

Approvals



UL UL514B
File No. E60625

IP Rating

For use with: Type SPL / SPLHC / SPUL / SPL-EF / LFH-SPL

IP Rating	Appropriate Conduit
IP54	N/A
IP65	N/A
IP66	Yes
IP67	Yes
IP68	Yes (10 bar 30 mins)
IP69K	Yes

Temperature Range

Static Applications: -65°C to +150°C

Moving Applications: -45°C to +150°C



Type 45
45° Elbow

Type 45 - Adaptasteel

45° Elbow - Fixed External Male Thread / For insertion into threaded entries & knockouts using a locknut (order locknut separately)

Materials: Nickel plated brass

Part No.	Nominal Conduit Size	US Conduit Size	Metric Thread	Part No.	Nominal Conduit Size	US Conduit Size	NPT Thread
SPL16/M16/C45	16mm	3/8"	M16	SPL16/038/C45	16mm	3/8"	3/8"
SPL16/M20/C45	16mm	3/8"	M20	SPL16/050/C45	16mm	3/8"	3/8"
SPL20/M20/C45	20mm	1/2"	M20	SPL20/050/C45	20mm	1/2"	1/2"
SPL25/M25/C45	25mm	3/4"	M25	SPL25/075/C45	25mm	3/4"	3/4"
SPL32/M32/C45	32mm	1"	M32	SPL32/100/C45	32mm	1"	1"
SPL40/M40/C45	40mm	1 1/4"	M40	SPL40/125/C45	40mm	1 1/4"	1 1/4"
SPL50/M50/C45	50mm	1 1/2"	M50	SPL50/150/C45	50mm	1 1/2"	1 1/2"
SPL63/M63/C45	63mm	2"	M63	SPL63/200/C45	63mm	2"	2"

Approvals



UL UL514B
File No. E60625

IP Rating

For use with: Type SPL / SPLHC / SPUL / SPL-EF / LFH-SPL

IP Rating	Appropriate Conduit
IP54	N/A
IP65	N/A
IP66	Yes
IP67	Yes
IP68	Yes (10 bar 30 mins)
IP69K	Yes

Temperature Range

Static Applications: -65°C to +150°C

Moving Applications: -45°C to +150°C

Metallic conduit systems

EMI screen Type SB & STC - Adaptasteel

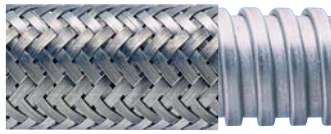

Type SB
Galvanised Steel,
Overbraided Steel,
Enhanced EMI Screening,
Flexible Conduit

Type SB - Adaptasteel

Galvanised Steel, Overbraided Steel, Enhanced EMI Screening, Flexible Conduit

Materials: Galvanised Steel Conduit, Galvanised Steel Overbraid

Part No.	Nominal Conduit Size	Outside Diameter	Inside Diameter	Min. Bend Radius	Reel Length
SB10	10mm	10.0mm	6.8mm	25mm	25m
SB12	12mm	14.0mm	10.3mm	30mm	25m
SB16	16mm	17.5mm	13.0mm	35mm	25m
SB20	20mm	21.5mm	16.9mm	45mm	25m
SB25	25mm	26.0mm	21.4mm	55mm	25m
SB32	32mm	34.0mm	28.1mm	60mm	10m
SB40	40mm	43.6mm	37.7mm	80mm	10m
SB50	50mm	56.0mm	48.4mm	90mm	10m
SB63	63mm	65.0mm	57.5mm	115mm	10m
SB75	75mm	80.0mm	70.0mm	150mm	10m

To order quote part number & reel length, e.g. SB12/25M

Approvals



IP Rating	Appropriate Fitting	Temperature Range	UV Resistance
For use with: Type SB		Static Applications: -50°C to +300°C	Very High
IP40	Type SB - Type A & B	Moving Applications: -45°C to +250°C	
IP65	N/A	Flexibility & Fatigue Life	
IP66	N/A	High Flexibility - High Fatigue Life	
IP67	N/A	Fire Performance & EMI Screen	
IP68	N/A		
IP69K	N/A		



Type STC
Galvanised Steel,
Overbraided Tinned Copper,
High EMI Screening,
Flexible Conduit

Type STC - Adaptasteel

Galvanised Steel, Overbraided Tinned Copper, High EMI Screening, Flexible Conduit

Materials: Galvanised Steel Conduit, Tinned Copper Overbraid

Part No.	Nominal Conduit Size	Outside Diameter	Inside Diameter	Min. Bend Radius	Reel Length
STC10	10mm	10.0mm	6.8mm	25mm	25m
STC12	12mm	14.0mm	10.3mm	30mm	25m
STC16	16mm	17.5mm	13.0mm	35mm	25m
STC20	20mm	21.5mm	16.9mm	45mm	25m
STC25	25mm	26.0mm	21.4mm	55mm	25m
STC32	32mm	34.0mm	28.1mm	60mm	10m
STC40	40mm	43.6mm	37.7mm	80mm	10m
STC50	50mm	56.0mm	48.4mm	90mm	10m

To order quote part number & reel length, e.g. STC12/25M

Approvals



IP Rating	Appropriate Fitting	Temperature Range	UV Resistance
For use with: Type SB		Static Applications: -50°C to +300°C	Very High
IP40	Type SB - Type A & B	Moving Applications: -45°C to +250°C	
IP65	N/A	Flexibility & Fatigue Life	
IP66	N/A	High Flexibility - High Fatigue Life	
IP67	N/A	Fire Performance & EMI Screen	
IP68	N/A		
IP69K	N/A		



Metallic conduit systems

EMI screen Type SSB & SSBGS - Adaptasteel

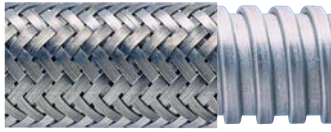

Type SSB
Overbraided,
Standard EMI Screening,
Flexible Conduit

3

Type SSB - Adaptasteel

Overbraided, Standard EMI Screening, Flexible Conduit

Materials: Stainless Steel Conduit, Stainless Steel Overbraid

Part No.	Nominal Conduit Size	Outside Diameter	Inside Diameter	Min. Bend Radius	Reel Length
SSB12	12mm	14.0mm	10.3mm	30mm	25m
SSB16	16mm	17.5mm	13.0mm	35mm	25m
SSB20	20mm	21.5mm	16.9mm	45mm	25m
SSB25	25mm	26.0mm	21.4mm	55mm	25m
SSB32	32mm	34.0mm	28.1mm	60mm	10m

To order quote part number & reel length, e.g. SSB12/25M

Approvals



IP Rating	Appropriate Fitting	Temperature Range	UV Resistance
For use with: Type SB		Static Applications: -50°C to +300°C	Very High
IP40	Type SB - Type A & B	Moving Applications: -45°C to +250°C	
IP65	N/A	Flexibility & Fatigue Life	
IP66	N/A	High Flexibility - High Fatigue Life	
IP67	N/A	Fire Performance & EMI Screen	
IP68	N/A		
IP69K	N/A		

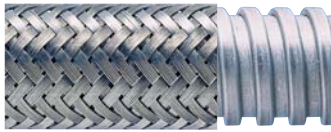

Type SSBGS
Overbraided,
Standard EMI Screening,
Flexible Conduit

Type SSBGS - Adaptasteel

Overbraided, Standard EMI Screening, Flexible Conduit

Materials: Galvanised Steel Conduit, Stainless Steel Overbraid

Part No.	Nominal Conduit Size	Outside Diameter	Inside Diameter	Min. Bend Radius	Reel Length
SSBGS12	12mm	14.0mm	10.3mm	30mm	25m
SSBGS16	16mm	17.5mm	13.0mm	35mm	25m
SSBGS20	20mm	21.5mm	16.9mm	45mm	25m
SSBGS25	25mm	26.0mm	21.4mm	55mm	25m
SSBGS32	32mm	34.0mm	28.1mm	60mm	10m

To order quote part number & reel length, e.g. SSBGS12/25M

Approvals



IP Rating	Appropriate Fitting	Temperature Range	UV Resistance
For use with: Type SB		Static Applications: -50°C to +300°C	Very High
IP40	Type SB - Type A & B	Moving Applications: -45°C to +250°C	
IP65	N/A	Flexibility & Fatigue Life	
IP66	N/A	High Flexibility - High Fatigue Life	
IP67	N/A	Fire Performance & EMI Screen	
IP68	N/A		
IP69K	N/A		



Metallic conduit systems

EMI screen Type A & B - Adaptasteel



Type A
Straight Fitting

Type A - Adaptasteel

Straight Fitting - Fixed External Male Thread / For insertion into knockouts using a locknut (order locknuts separately)

Materials: Nickel plated brass

Part No.	Nominal Conduit Size	Metric Thread
SB10/M12/A	10mm	M12
SB12/M16/A	12mm	M16
SB16/M16/A	16mm	M16
SB20/M20/A	20mm	M20
SB25/M25/A	25mm	M25
SB32/M32/A	32mm	M32
SB40/M40/A	40mm	M40
SB50/M50/A	50mm	M50
SB63/M63/A	63mm	M63
SB75/M75/A	75mm	M75

Approvals



IP Rating	Appropriate Conduit	Temperature Range
For use with: Type SB / STC / SSB / SSBGS		
IP40	Yes	Static Applications: -50°C to +300°C Moving Applications: -45°C to +250°C
IP65	N/A	
IP66	N/A	
IP67	N/A	
IP68	N/A	
IP69K	N/A	



Type B
Straight Fitting

Type B - Adaptasteel

Straight Fitting - Swivel External Male Thread / For insertion into threaded entries & knockouts using a locknut (order locknut separately)

Materials: Nickel plated brass

Part No.	Nominal Conduit Size	Metric Thread
SB10/M12/B	10mm	M12
SB12/M16/B	12mm	M16
SB16/M16/B	16mm	M16
SB20/M20/B	20mm	M20
SB25/M25/B	25mm	M25
SB32/M32/B	32mm	M32
SB40/M40/B	40mm	M40
SB50/M50/B	50mm	M50

Approvals



IP Rating	Appropriate Conduit	Temperature Range
For use with: Type SB / STC / SSB / SSBGS		
IP40	Yes	Static Applications: -50°C to +300°C Moving Applications: -45°C to +250°C
IP65	N/A	
IP66	N/A	
IP67	N/A	
IP68	N/A	
IP69K	N/A	

Fitting Characteristics



Metallic conduit systems

EMI screen, liquid resistant Type SPB & SPTC - Adaptasteel



Type SPB
Overbraided,
Enhanced EMI Screening,
Flexible Conduit

3

Type SPB - Adaptasteel

Overbraided, Enhanced EMI Screening, Flexible Conduit

Materials: Galvanised Steel Conduit with PVC Covering, Galvanised Steel Overbraid

Part No.	Nominal Conduit Size	Outside Diameter	Inside Diameter	Min. Bend Radius	Reel Length
SPB10	10mm	11.5mm	6.8mm	25mm	25m
SPB12	12mm	15.5mm	10.3mm	25mm	25m
SPB16	16mm	18.5mm	13.0mm	30mm	25m
SPB20	20mm	23.0mm	16.9mm	35mm	25m
SPB25	25mm	27.5mm	21.4mm	55mm	25m
SPB32	32mm	35.5mm	28.1mm	60mm	10m
SPB40	40mm	45.1mm	37.7mm	80mm	10m
SPB50	50mm	57.5mm	48.4mm	90mm	10m

To order quote part number & reel length, e.g. SPB12/25M

Approvals



IP Rating	Appropriate Fitting	Temperature Range	UV Resistance
For use with: Type SPB		Static Applications: -15°C to +70°C	Very High
IP54	Type SB - Type A & B	Moving Applications: -5°C to +90°C	
IP65	N/A	Flexibility & Fatigue Life	
IP66	N/A	High Flexibility - Medium Fatigue Life	
IP67	N/A	Fire Performance & EMI Screen	
IP68	N/A	Self Extinguishing	
IP69K	N/A		



Type SPTC
Overbraided Tinned Copper,
High EMI Screening,
Flexible Conduit

Type SPTC - Adaptasteel

Overbraided Tinned Copper, High EMI Screening, Flexible Conduit

Materials: Galvanised Steel Conduit with PVC Covering, Tinned Copper Overbraid

Part No.	Nominal Conduit Size	Outside Diameter	Inside Diameter	Min. Bend Radius	Reel Length
SPTC10	10mm	11.5mm	6.8mm	25mm	25m
SPTC12	12mm	15.5mm	10.3mm	25mm	25m
SPTC16	16mm	18.5mm	13.0mm	30mm	25m
SPTC20	20mm	23.0mm	16.9mm	35mm	25m
SPTC25	25mm	27.5mm	21.4mm	55mm	25m
SPTC32	32mm	35.5mm	28.1mm	60mm	10m
SPTC40	40mm	45.1mm	37.7mm	80mm	10m
SPTC50	50mm	57.5mm	48.4mm	90mm	10m

To order quote part number & reel length, e.g. SPTC12/25M

Approvals



IP Rating	Appropriate Fitting	Temperature Range	UV Resistance
For use with: Type SB		Static Applications: -15°C to +70°C	Very High
IP54	Type SB - Type A & B	Moving Applications: -5°C to +90°C	
IP65	N/A	Flexibility & Fatigue Life	
IP66	N/A	High Flexibility - Medium Fatigue Life	
IP67	N/A	Fire Performance & EMI Screen	
IP68	N/A	Self Extinguishing	
IP69K	N/A		

Metallic conduit systems

EMI screen, liquid resistant Type A & B - Adaptasteel



Type A
Straight Fitting

Type A - Adaptasteel

Straight Fitting - Fixed External Male Thread / For insertion into knockouts using a locknut (order locknut separately)

Materials: Nickel plated brass

Part No.	Nominal Conduit Size	Metric Thread
SPB10/M12/A	10mm	M12
SPB12/M16/A	12mm	M16
SPB16/M16/A	16mm	M16
SPB20/M20/A	20mm	M20
SPB25/M25/A	25mm	M25
SPB32/M32/A	32mm	M32
SPB40/M40/A	40mm	M40
SPB50/M50/A	50mm	M50

Approvals



IP Rating

Appropriate Conduit

Temperature Range

For use with: Type SPB / SPTC

Static Applications: -50°C to +300°C

Moving Applications: -45°C to +250°C

IP54	Yes
IP65	N/A
IP66	N/A
IP67	N/A
IP68	N/A
IP69K	N/A



Type B
Straight Fitting

Type B - Adaptasteel

Straight Fitting - Swivel External Male Thread / For insertion into threaded entries & knockouts using a locknut (order locknut separately)

Materials: Nickel plated brass

Part No.	Nominal Conduit Size	Metric Thread
SPB10/M12/B	10mm	M12
SPB12/M16/B	12mm	M16
SPB16/M16/B	16mm	M16
SPB20/M20/B	20mm	M20
SPB25/M25/B	25mm	M25
SPB32/M32/B	32mm	M32
SPB40/M40/B	40mm	M40
SPB50/M50/B	50mm	M50

Approvals



IP Rating

Appropriate Conduit

Temperature Range

For use with: Type SPB / SPTC

Static Applications: -50°C to +300°C

Moving Applications: -45°C to +250°C

IP54	Yes
IP65	N/A
IP66	N/A
IP67	N/A
IP68	N/A
IP69K	N/A

Fitting Characteristics



Metallic conduit systems

Liquid resistant, high strength Type SPLHCB & A - Adaptasteel



Type SPLHCB
Extreme Temperature,
Abuse Resistant, Overbraided,
Standard EMI Screening,
Flexible Conduit

3

Type SPLHCB - Adaptasteel

Extreme Temperature, Abuse Resistant, Overbraided, Standard EMI Screening, Flexible Conduit

Materials: Galvanised Steel Conduit, Smooth Thermoplastic Rubber Covering, Stainless Steel 316 Overbraid

Part No.	Nominal Conduit Size	Outside Diameter	Inside Diameter	Min. Bend Radius	Reel Length
SPLHCB16	16mm	19.8mm	12.5mm	80mm	25m
SPLHCB20	20mm	23.1mm	15.9mm	95mm	25m
SPLHCB25	25mm	28.4mm	21.0mm	115mm	25m
SPLHCB32	32mm	35.1mm	26.7mm	145mm	10m
SPLHCB40	40mm	44.0mm	35.4mm	180mm	10m
SPLHCB50	50mm	56.0mm	40.4mm	240mm	10m

To order quote part number & reel length, e.g. SPLHCB16/25M

Approvals



IP Rating	Appropriate Fitting	Temperature Range	UV Resistance
For use with: Type SPLB		Static Applications: -65°C to +135°C	Very High
IP40	N/A	Moving Applications: -45°C to +150°C	
IP65	N/A	Flexibility & Fatigue Life	
IP66	Type SPLB - Type A & B	Very High Flexibility - High Fatigue Life	
IP67	Type SPLB - Type A & B	Fire Performance & EMI Screen	
IP68	Type SPLB - Type A & B	Self Extinguishing	
IP69K	N/A	Halogen Free	



Type A
Straight Fitting

Type A - Adaptasteel

Straight Fitting - Fixed External Male Thread / For insertion into knockouts using a locknut (order locknut separately)

Materials: Nickel plated brass

Part No.	Nominal Conduit Size	Metric Thread
SPLB16/M16/A	16mm	M16
SPLB16/M20/A	16mm	M20
SPLB20/M20/A	20mm	M20
SPLB25/M25/A	25mm	M25
SPLB32/M32/A	32mm	M32
SPLB40/M40/A	40mm	M40
SPLB50/M50/A	50mm	M50

Approvals



IP Rating	Appropriate Conduit	Temperature Range
For use with: Type SPLHCB		Static Applications: -65°C to +135°C
IP40	N/A	Moving Applications: -45°C to +150°C
IP65	N/A	
IP66	Yes	
IP67	Yes	
IP68	Yes (10 bar 30mins)	
IP69K	N/A	

Metallic conduit systems

Liquid resistant, high strength Type B - Adaptasteel



Type B
Straight Fitting

Type B - Adaptasteel

Straight Fitting - Swivel External Male Thread / For insertion into threaded entries & knockouts using a locknut (order locknut separately)

Materials: Nickel plated brass

Part No.	Nominal Conduit Size	Metric Thread
SPLB16/M16/B	16mm	M16
SPLB16/M20/B	16mm	M20
SPLB20/M20/B	20mm	M20
SPLB25/M25/B	25mm	M25
SPLB32/M32/B	32mm	M32

Approvals



IP Rating	Appropriate Conduit	Temperature Range
For use with: Type SPLHCB		Static Applications: -65°C to +135°C
IP40	N/A	Moving Applications: -45°C to +150°C
IP65	N/A	
IP66	Yes	
IP67	Yes	
IP68	Yes (10 bar 30mins)	
IP69K	N/A	

Fitting Characteristics



Metallic conduit systems

Accessories - Type LNB/LNS, P & PSA

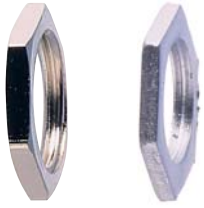

3 Type LNB Metallic Locknuts



LNS Locknut

Type LNB/LNS

Metallic Locknuts / Materials: Nickel Plated Brass, Galvanised Steel

Metric Thread	Part No.		PG Thread	Part No.		NPT Thread	Part No.
	Nickel Plated Brass	Galvanised Steel		Nickel Plated Brass	Steel		
M12 x 1.0	LNB/M12X1		PG7	LNB/PG7		3/8"	LNS/038
M12 x 1.5	LNB/M12		PG9	LNB/PG9		1/2"	LNS/050
M16	LNB/M16	LNS/M16	PG11	LNB/PG11		3/4"	LNS/075
M20	LNB/M20	LNS/M20	PG13,5	LNB/PG13		1"	LNS/100
M25	LNB/M25	LNS/M25	PG16	LNB/PG16		1 1/4"	LNS/125
M32	LNB/M32	LNS/M32	PG21	LNB/PG21		1 1/2"	LNS/150
M40	LNB/M40		PG29	LNB/PG29		2"	LNS/200
M50	LNB/M50		PG36	LNB/PG36			
M63	LNB/M63		PG42	LNB/PG42			
M75	LNB/M75		PG48	LNB/PG48			



Type P
P-Clip Conduit Support

Type P

P-Clip Conduit Support / Materials: Plated Steel or Stainless Steel Construction with PVC Insert

Plated Steel Part No.	Stainless Steel Part No.	Nominal Conduit Size	Plated Steel Part No.	Stainless Steel Part No.	Nominal Conduit Size
PCLIP/10		10	PCLIP/32	PCLIP/32SS	32
PCLIP/12		12	PCLIP/40		40
PCLIP/16	PCLIP/16SS	16	PCLIP/50		50
PCLIP/20	PCLIP/20SS	20	PCLIP/63		63
PCLIP/25	PCLIP/25SS	25	PCLIP/75		75



Type PSA
Proximity Switch Connectors

Type PSA

Proximity Switch Connectors / Materials: Nickel Plated Brass

Internal Thread	Part No.	
	To M16 Internal Thread	To PG9 Internal Thread
M12 x 1.0	PSA16/M12	PSA9/M12
M18 x 1.0	PSA16/M18	PSA9/M18
M30	PSA16/M30	PSA9/M30

Metallic conduit systems

Accessories - Type 90/45, TC & Female couplers



Type 90 Brass Elbow



Type 45 Brass Elbow

Type 90/45

Brass Elbows / Materials: Nickel Plated Brass

Metric External Male Thread	Internal Female Metric Thread	Part No.		NPT External Male Thread	Internal Female Metric Thread	Part No.		PG External Male Thread	Internal Female Metric Thread	Part No.	
		Type 90°	Type 45°			Type 90°	Type 45°			Type 90°	Type 45°
M16	M16	B/M16/90		1/2"	M20	B/050/90	B/050/45	PG9	M16	B/PG9/90	
M16	M20		B/M16/45	3/4"	M25	B/075/90	B/075/45	PG11	M16	B/PG11/90	B/PG11/45
M20	M20	B/M20/90	B/M20/45	1"	M32	B/100/90	B/100/45	PG13,5	M20	B/PG13/90	B/PG13/45
M25	M25	B/M25/90	B/M25/45					PG16	M20	B/PG16/90	B/PG16/45
M32	M32	B/M32/90	B/M32/45					PG21	M25	B/PG21/90	B/PG21/45



Type TC
Unef Converter

Type TC

Unef Thread Converter with Two Internal Female Threads / Materials: Nickel Plated Brass

Internal Thread	To M16 Internal Thread	To M20 Internal Thread	To M25 Internal Thread	To M32 Internal Thread
5/8" UNEF	B/063U-M16/TC			
3/4" UNEF	B/075U-M16/TC	B/075U-M20/TC		
7/8" UNEF		B/088U-M20/TC		
1" UNEF		B/100U-M20/TC	B/100U-M25/TC	
1 3/16" UNEF		B/119U-M20/TC	B/119U-M25/TC	
1 5/16" UNEF		B/131U-M20/TC		
1 7/16" UNEF			B/144U-M25/TC	B/144U-M32/TC



Female Coupler
Brass Female Coupler

Female Coupler

Brass Internal Female Coupler / Materials: Nickel Plated Brass

Part No.	Metric Thread	Part No.	Metric Thread
B/M16/C	M16	B/M40/C	M40
B/M20/C	M20	B/M50/C	M50
B/M25/C	M25	B/M63/C	M63
B/M32/C	M32	B/M75/C	M75

Metallic conduit systems

Accessories - Type E, R & TC

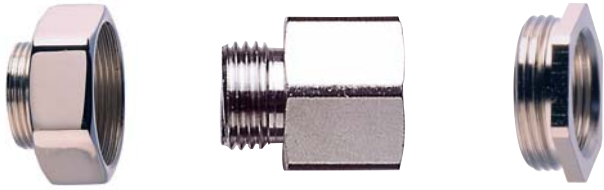

Type E, R & C
Enlargers, Reducers & Converters

3

Type E / Type R / Type C

Enlargers, Reducers & Converters / **Materials:** Nickel Plated Brass

External Thread	To PG7 Internal Thread	To PG9 Internal Thread	To PG11 Internal Thread	To PG13,5 Internal Thread	To PG16 Internal Thread	To PG21 Internal Thread	To PG29 Internal Thread
M16	B/M16-PG7/TC	B/M16-PG9/TC	B/M16-PG11/TC				
M20	B/M20-PG7/TC	B/M20-PG9/TC	B/M20-PG11/TC	B/M20-PG13/TC	B/M20-PG16/TC	B/M20-PG21/TC	
M25						B/M25-PG21/TC	
M32							B/M32-PG29/TC
M40							
M50							
PG7		B/PG7-PG9/E					
PG9	B/PG9-PG7/R		B/PG9-PG11/E	B/PG9-PG13/E			
PG11	B/PG11-PG7/R	B/PG11-PG9/R		B/PG11-PG13/E	B/PG11-PG16/E		
PG13,5	B/PG13-PG7/R	B/PG13-PG9/R	B/PG13-PG11/R		B/PG13-PG16/E	B/PG13-PG21/E	
PG16	B/PG16-PG7/R	B/PG16-PG9/R	B/PG16-PG11/R	B/PG16-PG13/R		B/PG16-PG21/E	
PG21			B/PG21-PG11/R	B/PG21-PG13/R	B/PG21-PG16/R		B/PG21-PG29/E
PG29					B/PG29-PG16/R	B/PG29-PG21/R	
PG36						B/PG36-PG21/R	B/PG36-PG29/R
PG42							B/PG42-PG29/R
PG48							

External Thread	To M10 Internal Thread	To M12 Internal Thread	To M16 Internal Thread	To M20 Internal Thread	To M25 Internal Thread	To M32 Internal Thread	To M40 Internal Thread
M16		B/M16-M12/R		B/M16-M20/E			
M20	B/M20-M10/R	B/M20-M12/R	B/M20-M16/R		B/M20-M25/E		
M25				B/M25-M20/R		B/M25-M32/E	
M32					B/M32-M25/R		
M40						B/M40-M32/R	
M50							B/M50-M40/R
PG7			B/PG7-M16/TC	B/PG7-M20/TC			
PG9			B/PG9-M16/TC	B/PG9-M20/TC			
PG11			B/PG11-M16/TC	B/PG11-M20/TC			
PG13,5			B/PG13-M16/TC	B/PG13-M20/TC			
PG16			B/PG16-M16/TC	B/PG16-M20/TC	B/PG16-M25/TC		
PG21			B/PG21-M16/TC	B/PG21-M20/TC	B/PG21-M25/TC	B/PG21-M32/TC	
PG29				B/PG29-M20/TC	B/PG29-M25/TC	B/PG29-M32/TC	B/PG29-M40/TC
PG36						B/PG36-M32/TC	B/PG36-M40/TC
PG42							
PG48							
1/2" NPT			B/050-M16/TC	B/050-M20/TC			

To PG36 Internal Thread	To PG42 Internal Thread	To PG48 Internal Thread
B/PG29-PG36/E		
	B/PG36-PG42/E	B/PG36-PG48/E
B/PG42-PG36/R		B/PG42-PG48/E
B/PG48-PG36/R	B/PG48-PG42/R	

To 1/2" NPT Internal Thread
B/M20-050/TC
B/PG11-050/TC
B/PG16-050/TC

Convenience packs

Professional installer conduit systems

Convenience Packs

LFH Convenience	4/2
Budget Convenience	4/2
Retail / Office Convenience	4/2
Liquid Resistant Convenience	4/2

Convenience packs

Professional installer conduit systems

LFH Convenience

Convenience Pack / Nylon Conduit with Adaptalok One-Piece, Fast Fit, Push & Twist Fittings

Materials: Polyamide Nylon 6 / **Colour:** Black (BL)



Part No.	Type	Conduit / Fitting Diameter	One-Piece Conduit Fittings	Locknuts
CP-AF20A	10m Black Type PA LFH Nylon 6, 20mm diameter	20mm	10	10
CP-AF25A	10m Black Type PA LFH Nylon 6, 25mm diameter	25mm	10	10
AL21/M20/A/BL	Pack of 10 Black Fittings (Straight), 20mm diameter	20mm	10	10
AL28/M25/A/BL	Pack of 10 Black Fittings (Straight), 28mm diameter	28mm	10	10

4

Budget Convenience

Convenience Pack / Type PP Polypropylene Conduit with One-Piece, Fast Fit, Push & Twist Fittings

Materials: PP Polypropylene / **Colour:** Grey (GR)



Part No.	Type	Conduit / Fitting Diameter	One-Piece Conduit Fittings	Locknuts
CP-AF20BS-PP	10m Grey Type PP Polypropylene, 20mm diameter	20mm	10	10
CP-AF25BS-PP	10m Grey Type PP Polypropylene, 25mm diameter	25mm	10	10
CP-AF20A-APP	Pack of 10 Grey Fittings (Straight), 20mm diameter	20mm	10	
CP-AF25A-APP	Pack of 10 Grey Fittings (Straight), 25mm diameter	25mm	10	

Retail / Office Convenience

Convenience Pack / Self-Extinguishing PVC Conduit & One-Piece Fittings & Locknuts

Materials: PVC Pliable / **Colour:** White (W), Grey (GR)



Part No.	Type	Conduit / Fitting Diameter	One-Piece Conduit Fittings	Locknuts
CP-AF20BS	10m White Type KF PVCu, 20mm diameter	20mm	10	10
CP-AF25BS	10m White Type KF PVCu, 20mm diameter	25mm	10	10
CP-KF20BS	10m Grey Type KF PVCu, 25mm diameter	20mm	10	10
CP-KF25BS	10m Grey Type KF PVCu, 25mm diameter	25mm	10	10

Liquid Resistant Convenience

Convenience Pack / Type SP Adaptasteel PVC Covered Steel Conduit

with Fixed and Swivel Fittings

Materials: PVC Covered Galvanised Steel / **Colour:** Black (BL)



Part No.	Conduit Type	Conduit Diameter	Adaptasteel Fittings	Locknuts
CP-AF20SP-BS	10m Black Type SP PVC Covered Steel	20mm	N/A	10



IP Rating
IP66
IP66
IP66
IP66



IP Rating
IP54
IP54
IP54
IP54

IP Rating
IP66
IP66
IP66
IP66



Fixed Male Fitting	Swivel Male Fitting	IP Rating
5	5	IP54

Cutting Tools

Cutting tools for flexible conduit systems

Cutting Tools

Kwikcut	5/2
Swingcut	5/2
Cut-Vice	5/3
Rotocut	5/3

Cutting Tools

Kwikcut & Swingcut

5



Kwikcut cutting tool

Kwikcut

Part No.

KWIKCUT

Kwikcut

Kwikcut is the ideal cutting tool for non-metallic conduits (PA, PF, PI, PR, PADL, CP, KFL, KFS, KFM, PP, XF & PK) up to 32mm.

Instructions

Place the conduit between the cutting blade and lower support, squeeze the handles and rotate the conduit for a clean, easy cut. Spare blades are available.



Swingcut cutting tool

Swingcut

Part No.

SWINGCUT

Swingcut

Swingcut is a versatile vice and saw combination tool which facilitates a neat, square cut for liquid tight and pliable conduits between 10mm and 32mm. Six to one leverage advantage provides a strong cutting action.

Instructions

Place the conduit in the vice and secure. Move the operating handle backwards and forwards whilst applying increasing pressure to the supporting handle.

Hardened captive spring loaded retaining pins make blade replacement easy. Spare blades are available.

Cutting Tools

Cut-Vice & Rotocut

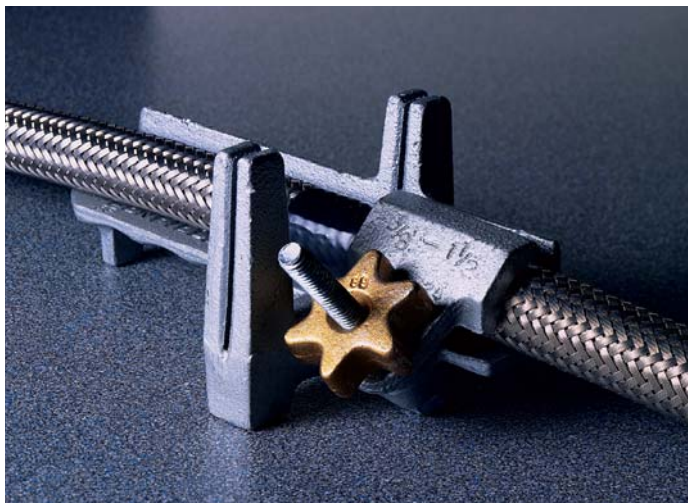

Cut-Vice cutting tool

Cut-Vice

Part No.

CUT-VICE

Cut-Vice

Cut-vice offers the ability to produce a clean cut for conduit sizes 16mm to 40mm.

Instructions

Place the conduit along the vice body and tighten the clamp. Holding the conduit and integral handle together, insert a hacksaw blade into the guide and cut. For braided conduit, wrap adhesive tape around the cutting point to secure braid. Remove tape after cutting.



Rotocut cutting tool

Rotocut

Part No.

ROTOCUT

Rotocut

Rotocut offers a simple but effective method for cutting 20mm and 25mm S, SS, SP, LFH-SP and SN steel conduit types.

Instructions

Adjust the clamping pin so that the conduit is just held in the recess. Squeeze the lever and body whilst rotating the cutting blade. When the blade appears on the inside of the conduit, release the pressure and remove the conduit. A simple twist will then separate the two parts. Where the conduit is covered, the covering can be cut prior to separation. Spare blades are available.

Cable glands & terminal blocks

Accessories

Cable Glands & Terminal Blocks

Introduction	6/3
--------------	-----

Cable Glands

Standard - Cable gland	6/4
Index A2P - Cable gland	6/5
Euro Index - Cable gland	6/5
Index Claw - Cable gland	6/6
Index EMC - Cable gland	6/7
Miniature - Cable gland	6/8
Cord Grip Bush	6/8
Clamping Bush	6/9
Stopping Plugs	6/9

Terminal Blocks

Type 1512 - Terminal block	6/10
Type 4012 - Terminal block	6/10
Type 6012 - Terminal block	6/11
Type 10012 - Terminal block	6/11
Type 16012 - Terminal block	6/12



Cable glands & terminal blocks

Introduction

Range overview

Incorporating high quality design and manufacture, products include cable glands and terminal blocks.

Cable Glands

Cable Glands provide sealing and retention for a wide range of cables for general indoor and outdoor applications.

The Standard Range of “Hex” cable glands has been widely recognised as the UK “Industry Standard” for plastic cable glands for over 30 years offering excellent all-round performance. Euro Index is the next generation of Cable Glands with enhanced IP and load functionality. Also available is the Index Cable Gland range providing high strength and performance for a variety of applications. A range of accessories are available including seals, grommets, metric adaptors and reducers, locknuts and sealing washers.

Terminal Blocks

The general purpose 12 pole products are competitively priced, polyethylene terminal blocks that offer flexibility, versatility, are neutrally coloured and come with CE Approval. Available in 3, 5, 15 and 30 Amp loads they are easily cut into the required number of poles and can be mounted on a surface within an enclosure.



The range of terminal blocks is now available in standard 12-pole options. The terminal blocks are moulded from a specially developed Polyamide 6/66 Copolymer, which meets the arduous glow wire tests as specified in International Standard IEC 60695-2-11 and IEC 60695-2-12. Available in a range of size's, terminal blocks are ideal for use in appliances, lighting, industrial, domestic, and commercial applications and the white terminal blocks are available with raised or level base options.



Cable glands & terminal blocks

Standard - cable gland

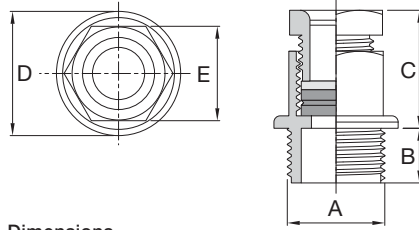

Standard Cable Gland

Dimensions

Standard - Cable Gland

General Purpose IP66 Cable Gland / Colour Key: Red ● / White ○ / Black ● / Grey ●

Materials: Polyamide 6.6 with Nitrile Rubber Seal / Colour: Red RAL 3031 (R), White RAL 9010 (W), Grey RAL 7030 (G), Black RAL 9005 (B)

Part No.	Metric Thread A	Thread Lengths B	Cable Max Diameter	Cable Min Diameter	Gland Depth C	Gland Diameter D	Across Flats Dimension E	Pack Quantity	Sealing Washer Part No.	Locknut Part No.	Colours
248	M16	10mm	6mm	4mm	25.0mm	22.0mm	19mm	100	96	92	● ○ ● ●
250	M16	10mm	10mm	7mm	25.0mm	22.0mm	19mm	100	96	92	● ○ ● ●
249	M20	11mm	6mm	4mm	25.0mm	25.0mm	19mm	100	97	93	● ○ ● ●
251	M20	11mm	10mm	7mm	25.0mm	25.0mm	19mm	100	97	93	● ○ ● ●
252	M20	11mm	13mm	8mm	30.5mm	26.0mm	23mm	100	97	93	● ○ ● ●
264	M25	12mm	6mm	4mm	25.0mm	31.5mm	19mm	100	98	94	● ○ ● ●
265	M25	12mm	10mm	7mm	25.0mm	31.5mm	19mm	100	98	94	● ○ ● ●
253	M25	12mm	13mm	8mm	30.5mm	31.5mm	23mm	100	98	94	● ○ ● ●
254	M25	12mm	18mm	12mm	32.5mm	32.0mm	28mm	100	98	94	● ○ ● ●
255	M32	13mm	24mm	18mm	35.0mm	41.0mm	36mm	100	99	95	● ○ ● ●
256	M16	20mm	6mm	4mm	25.0mm	22.0mm	19mm	100	96	92	● ○ ● ●
258	M16	20mm	10mm	7mm	25.0mm	22.0mm	19mm	100	96	92	● ○ ● ●
257	M20	20mm	6mm	4mm	25.0mm	25.0mm	19mm	100	97	93	● ○ ● ●
259	M20	20mm	10mm	7mm	25.0mm	25.0mm	19mm	100	97	93	● ○ ● ●
260	M20	20mm	13mm	8mm	30.5mm	26.0mm	23mm	100	97	93	● ○ ● ●
266	M25	20mm	6mm	4mm	25.0mm	31.5mm	19mm	100	98	94	● ○ ● ●
267	M25	20mm	10mm	7mm	25.0mm	31.5mm	19mm	100	98	94	● ○ ● ●
261	M25	20mm	13mm	8mm	30.5mm	31.5mm	23mm	100	98	94	● ○ ● ●
262	M25	20mm	18mm	12mm	32.5mm	32.0mm	28mm	100	98	94	● ○ ● ●
263	M32	20mm	24mm	18mm	35.0mm	41.0mm	36mm	100	99	95	● ○ ● ●

To order quote part number & colour, e.g. 248-W

Standard Cable gland gives good all-round performance and is the corner stone of Elkay's diverse cable gland range

Cable Glands can be supplied assembled with Locknuts and Sealing Washers as required

Cable glands & terminal blocks

Index A2P & Euro Index - cable glands



Index A2P Cable Gland

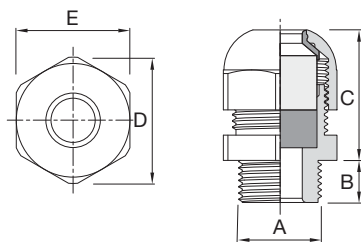

Dimensions

Index A2P - Cable Gland

High Performance IP68 upto 15bar Cable Gland / **Materials:** Polyamide 6.6 with Nitrile Rubber Seal

Colour: Black RAL 9005 (B)

Part No.	Metric Thread A	Thread Lengths B	Gland Length Compressed C	Cable Max Diameter	Cable Min Diameter	Gland Diameter D	Across Flats Dimension E	Pack Quantity	Sealing Washer	Locknut
200-8160	M16	15mm	24mm	8.0mm	4.0mm	26.0mm	24mm	50	96	92-B
200-8240	M20	15mm	24mm	8.0mm	4.0mm	26.0mm	24mm	50	97	93-B
200-8320	M20	15mm	25mm	10.0mm	7.5mm	30.0mm	27mm	50	97	93-B
200-8400	M20	15mm	26mm	13.2mm	9.5mm	35.5mm	32mm	50	97	93-B
200-8560	M25	15mm	28mm	18.0mm	13.0mm	40.0mm	36mm	25	98	94-B
200-8640	M32	15mm	31mm	25.0mm	17.5mm	51.0mm	46mm	10	99	95-B
200-8720	M40	15mm	31mm	31.5mm	24.5mm	61.0mm	55mm	10	121	111-B
200-8800	M50	15mm	31mm	37.0mm	31.0mm	78.0mm	70mm	5	122	112-B
200-8880	M50	15mm	31mm	43.0mm	36.5mm	78.0mm	70mm	5	122	112-B



Euro Index - Cable Gland

Euro Index - Cable Gland

IP68 Industrial 3 Part Plastic Cable Gland / **Materials:** Polyamide 6.6 with Nitrile Rubber Seal

Colour: Red RAL 3031 (R), White RAL 9010 (W), Grey RAL 7030 (G), Black RAL 9005 (B), Dark Grey RAL 7001 (DG)

Part No.	Metric Thread A	Thread Lengths B	Cable Max Diameter	Cable Min Diameter	Gland Depth C	Gland Diameter D	Across Flats Dimension E	Pack Quantity
ESM12-10	M12	8mm	6.5mm	2mm	23.0mm	19.0mm	17mm	100
ESM16-11	M16	9mm	10.0mm	4mm	25.5mm	23.5mm	21mm	100
ESM20-12	M20	10mm	12.0mm	6mm	27.0mm	27.0mm	24mm	100
ESM20-13	M20	10mm	14.0mm	10mm	28.5mm	30.0mm	27mm	100
ESM25-14	M25	11mm	18.0mm	13mm	29.0mm	33.0mm	30mm	100
ESM32-15	M32	12mm	25.0mm	17mm	37.0mm	45.5mm	41mm	50
ESM40-16	M40	13mm	32.0mm	24mm	42.0mm	55.5mm	50mm	25

To order quote part number & colour, e.g. ESM12-10B-LN

Approvals



IP Rating

IP68 Yes (5 bar 30mins)

Temperature Range

Static Applications: -20°C to +90°C

Halogen Free

Yes

Flammability

UL94 - V2 (Nylon material)

Key Features

- Smaller working envelope on bulkhead or panel
- Integral claw design prevents cable twisting during installation
- Wide cable acceptance range for each gland size
- Designed to EN 50262:1999

Cable glands & terminal blocks

Index Claw - cable gland

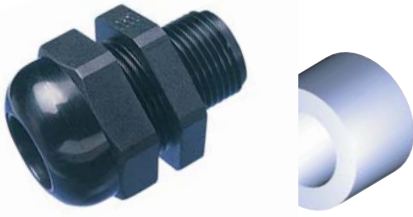

Index Claw Cable Gland

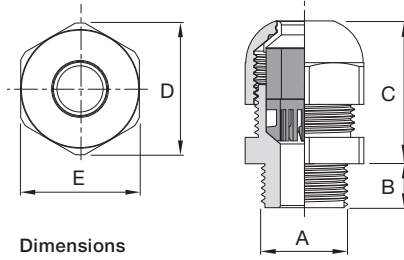

Dimensions

Index Claw - Cable Gland

High Performance IP68 Cable Gland

Materials: Polyamide 6.6 with Nitrile Rubber Seal / **Colour:** Black RAL 9005 (B)

Part No.	Metric Thread A	Thread Lengths B	Cable Max Diameter	Cable Min Diameter	Gland Depth C	Gland Diameter D	Across Flats Dimension E	Pack Quantity	Sealing Washer	Locknut Part No.
211-9020	M16	15mm	9mm	5mm	24mm	26mm	24mm	50	96	92-B
211-9060	M20	15mm	11mm	7mm	25mm	30mm	27mm	50	97	93-B
211-9140	M20	15mm	16mm	12mm	26mm	35mm	32mm	50	97	93-B

The Index Claw Gland is suitable for many applications where cables are subject to high tensile loads. Typical applications would range from portable equipment such as generators to highly mobile factory equipment. The performance of the Index Claw Gland allows for IP68 rating at 5 bar and cable anchorage of 15.9kgs

Approvals

IP Rating

IP68 Yes (5 bar 30min)

Temperature Range

Static Applications: -20°C to +90°C

Halogen Free

Yes

Flammability

UL94 - V2 (Nylon material)



Key Features

- Ideal for general use
- IP68 Protection (5 bar 30mins)
- Metric

Cable glands & terminal blocks

Index EMC Type A & B - cable glands

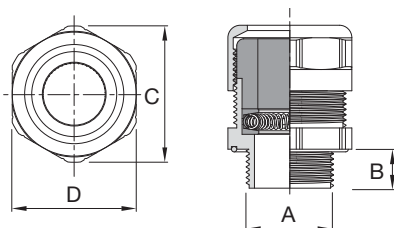

Index EMC Cable Gland

Dimensions

Index EMC Type A - Cable Gland

High Performance IP68 Cable Gland / **Materials:** Nickel Plated Brass, Stainless Steel Spring, Rubber Seal (TPE-V)

Part No.	Metric Thread A	Type	Thread Lengths B	Gland Diameter C	Across Flats Dimension D	Cable Max Diameter	Cable Min Diameter	Screen Dia. Max	Screen Dia. Min	Pack Quantity	Locknut Part No.
260-1050	M16	A	10mm	26.7mm	24mm	9mm	6mm	7.5mm	3.5mm	1	260-0500
260-1100	M16	A	10mm	26.7mm	24mm	11mm	7mm	8.5mm	4mm	1	260-0500
260-1200	M20	A	10mm	26.7mm	24mm	9mm	6mm	7.5mm	3mm	1	260-0600
260-1250	M20	A	10mm	26.7mm	24mm	11mm	7mm	8.5mm	4mm	1	260-0600
260-1300	M25	A	11mm	33.5mm	30mm	9.5mm	6mm	8.5mm	6mm	1	260-0650
260-1350	M25	A	11mm	33.5mm	30mm	11mm	6mm	9.0mm	6mm	1	260-0650
260-1700	M32	A	13mm	43.5mm	40mm	26mm	22mm	21.0mm	15mm	1	260-0700
260-1750	M40	A	14mm	54.0mm	50mm	29mm	25mm	25.0mm	18mm	1	260-0750
260-1900	M50	A	15mm	65.0mm	60mm	41mm	37mm	33.0mm	29mm	1	260-0800

6

Index EMC Type B - Cable Gland

High Performance IP68 Cable Gland / **Materials:** Nickel Plated Brass, Stainless Steel Spring, Rubber Seal (TPE-V)

Part No.	Metric Thread A	Type	Thread Lengths B	Gland Diameter C	Across Flats Dimension D	Cable Max Diameter	Cable Min Diameter	Screen Dia. Max	Screen Dia. Min	Pack Quantity	Locknut Part No.
260-1000	M16	B	10mm	26.7mm	24mm	6mm	4mm	6.0mm	3.0mm	1	260-0500
260-1150	M20	B	10mm	26.7mm	24mm	6mm	4mm	6.0mm	3.0mm	1	260-0600
260-1400	M25	B	11mm	33.5mm	30mm	11mm	6mm	10.5mm	6.0mm	1	260-0650
260-1450	M25	B	11mm	33.5mm	30mm	14mm	10mm	13.0mm	8.0mm	1	260-0650
260-1550	M25	B	11mm	33.5mm	30mm	18mm	14mm	17.5mm	12.5mm	1	260-0650
260-1650	M32	A/B	13mm	43.5mm	40mm	23mm	19mm	21.0mm	15.0mm	1	260-0700
260-1800	M40	B	14mm	54.0mm	50mm	32mm	29mm	30.5mm	24.0mm	1	260-0750

The INDEX Uni Iris range of cable glands are for use with screened cable and have been designed to connect the screen of the cable to the enclosure screening system. This is achieved by the use of two tapered rings applying force onto a continuous stainless steel spring washer pressing against the screen, ensuring positive contact. Assembly is simple, the screen is exposed, the spring and washers are slipped in place and then the gland can be tightened.

Approvals

IP Rating

Temperature Range

Halogen Free

IP68

Yes (10 bar 30min)

Static Applications: -40°C to +135°C

Yes



Key Features

- Screen continues into enclosure
- IP68 Protection at 10 bar for 30 minutes
- Metric
- For use with systems conforming to EN50 082-1/2

Type A

- Stripped Cable Sheath - Allowing the outer sheath to be completely stripped from the cable

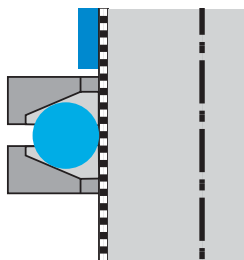

Type B

- Continuous Cable Sheath - Allowing for a ring of outer sheath only to be stripped

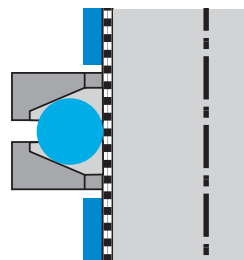

Cable glands & terminal blocks

Miniature gland & Cord grip bush

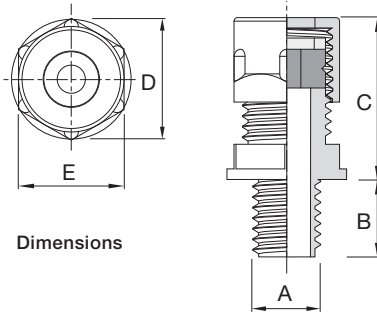

Miniature Gland

Dimensions

Miniature Gland

Small Cable Size IP66 Cable Gland

Materials: Polyamide 6.6 with Nitrile Rubber Seal / **Colour:** Black RAL 9005 (B), White RAL 9010 (W) - Black Part Numbers Listed

Part No.	Metric Thread A	Thread Lengths B	Cable Max Diameter	Cable Min Diameter	Gland Depth C	Gland Diameter D	Across Flats Dimension E	Pack Quantity	Sealing Washer	Locknut Part No.
238	M10	8mm	5mm	2mm	21mm	17mm	15mm	100	68	78-B
240	M10	8mm	7mm	5mm	21mm	17mm	15mm	100	68	78-B
244	M10	20mm	5mm	2mm	21mm	17mm	15mm	100	68	78-B
246	M10	20mm	7mm	5mm	21mm	17mm	15mm	100	68	78-B
239	M13	8mm	5mm	2mm	21mm	17mm	15mm	100	69	79-B
241	M13	8mm	7mm	5mm	21mm	17mm	15mm	100	69	79-B
245	M13	20mm	5mm	2mm	21mm	17mm	15mm	100	69	79-B
247	M13	20mm	7mm	5mm	21mm	17mm	15mm	100	69	79-B

Miniature cable glands are ideal for small cable sizes and offer IP66 protection. To order quote part number & colour, e.g. 238-W

Miniature cable glands are available with either long or short threads. Locknuts and sealing washers are available as separate items

Approvals

IP Rating	Temperature Range	Halogen Free	Flammability
IP66	Static Applications: -20°C to +90°C	Yes	UL94 - V2 (Nylon material)

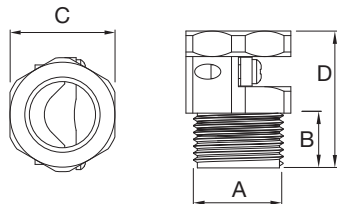

Cord Grip Bush

Dimensions

Cord Grip Bush

Cord Grip Entry Bush

Materials: Polyamide 6.6 / **Colour:** Black RAL 9005 (B)

Part No.	Metric Thread A	Thread Lengths B	Cable Max Diameter	Cable Min Diameter	Across Flats Dimension C	Overall Length D	Pack Quantity	Sealing Washer	Locknut Part No.
743-B	M16	9mm	11mm	3.5mm	19mm	23.5mm	100	96	92-B
744-B	M20	12mm	14mm	4.0mm	23mm	29.5mm	100	97	93-B
745-B	M25	12mm	18mm	8.0mm	27mm	29.5mm	100	98	94-B

Approvals

IP Rating	Temperature Range	Halogen Free	Flammability
IP66	Static Applications: -20°C to +90°C	Yes	UL94 - V2 (Nylon material)



Cable glands & terminal blocks

Clamping bush & Stopping plugs



Clamping Bush

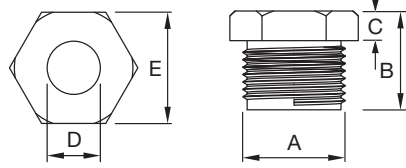

Dimensions

Clamping Bush

Smooth Cable Guide

Materials: Polyamide 6.6 / Colour: Black RAL 9005 (B)

Part No.	Metric Thread A	Plug Length B	Hexagon Thickness C	Hole Diameter D	Across Flats Dimension E	Pack Quantity
46-B	M16	14mm	5mm	10.5mm	19mm	100
47-B	M20	18mm	6mm	13.0mm	23mm	100
48-B	M25	18mm	6mm	19.0mm	28mm	100

Approvals



IP Rating	Temperature Range	Halogen Free	Flammability
IP66	Static Applications: -10°C to +90°C	Yes	UL94 - V2 (Nylon material)



Stopping Plug

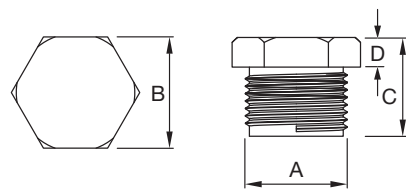

Dimensions

Stopping Plug

General Purpose IP66 Stopping Plug

Materials: Polyamide 6.6 / Colour: Black RAL 9005 (B)

Part No.	Metric Thread A	Across Flats Dimension B	Plug Length C	Head Depth D	Pack Quantity
64-B	M16	19mm	14mm	5mm	100
65-B	M20	23mm	18mm	6mm	100
66-B	M25	28mm	18mm	7mm	100
67-B	M32	36mm	19mm	3mm	100

Adaptaflex range of Stopping Plugs are ideal for sealing cable entries

Approvals



IP Rating	Temperature Range	Halogen Free	Flammability
IP66	Static Applications: -10°C to +90°C	Yes	UL94 - V2 (Nylon material)

Cable glands & terminal blocks

Type 1512 & 4012 polyamide - terminal blocks

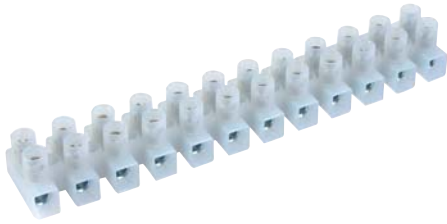

Type 1512 terminal block

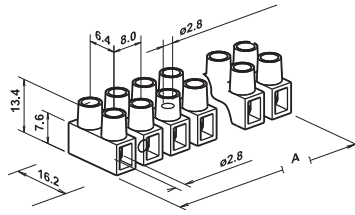

Dimensions

Type 1512 Polyamide - Terminal Block

2.5mm² Polyamide Terminal Blocks

Materials: Polyamide 6, Galvanised Brass Inserts & Galvanised Steel Screws / Colour: White

Part No.	Base	Wire Protector	'T' Insert	No. Poles	Width A	Rating	Pack Quantity
1512LE	Level			12 Pole	94mm	14A	50
1512/151E	Raised	Yes		12 Pole	94mm	14A	50
1512LTE	Level		Yes	12 Pole	94mm	14A	50
1512TE	Raised		Yes	12 Pole	94mm	14A	50

6

Approvals



Nominal Clamping Area	Nominal Voltage	Max Ambient Temp	Fire Performance	Flammability
2.5mm ²	450V	85°C	Halogen Free	UL94 - V2 (Nylon material)



Type 4012 terminal block

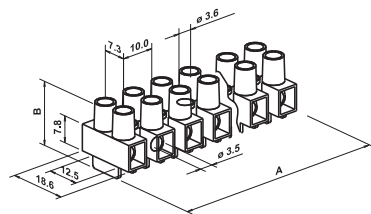

Dimensions

Type 4012 Polyamide - Terminal Block

4mm² Polyamide Terminal Blocks

Materials: Polyamide 6, Galvanised Brass Inserts & Galvanised Steel Screws / Colour: White

Part No.	Base	Wire Protector	'T' Insert	No. Poles	Width A	Height B	Rating	Pack Quantity
4012LE	Level			12 Pole	117mm	15.0mm	25A	50
4012/401E	Raised	Yes		12 Pole	117mm	18.5mm	25A	50
4012LT/402E	Level	Yes	Yes	12 Pole	117mm	15.0mm	25A	50
4012TE	Raised		Yes	12 Pole	117mm	18.5mm	25A	50

Approvals



Nominal Clamping Area	Nominal Voltage	Max Ambient Temp	Fire Performance	Flammability
4mm ²	450V	85°C	Halogen Free	UL94 - V2 (Nylon material)

Cable glands & terminal blocks

Type 6012 & 10012 polyamide - terminal blocks



Type 6012 terminal block

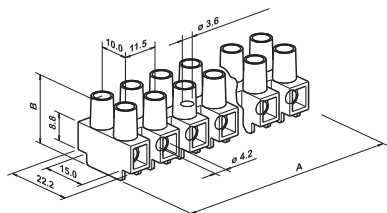

Dimensions

Type 6012 Polyamide - Terminal Block

6mm² Polyamide Terminal Blocks

Materials: Polyamide 6, Galvanised Brass Inserts & Galvanised Steel Screws / **Colour:** White

Part No.	Base	Wire Protector	'T' Insert	No. Poles	Width A	Height B	Rating	Pack Quantity
6012/601E	Raised	Yes		12 Pole	133.7mm	20.8mm	32A	25
6012TE	Raised		Yes	12 Pole	133.7mm	20.8mm	32A	25
6012L/601E	Level	Yes		12 Pole	133.7mm	19.3mm	32A	25
6012LE	Level			12 Pole	133.7mm	19.3mm	32A	25

Approvals



Nominal Clamping Area

6mm²

Nominal Voltage

450V

Max Ambient Temp

85°C

Fire Performance

Halogen Free

Flammability

UL94 - V2 (Nylon material)



Type 10012 terminal block

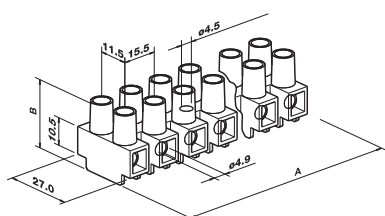

Dimensions

Type 10012 Polyamide - Terminal Block

10mm² Polyamide Terminal Blocks

Materials: Polyamide 6, Galvanised Brass Inserts & Galvanised Steel Screws / **Colour:** White

Part No.	Base	Wire Protector	'T' Insert	No. Poles	Width A	Height B	Rating	Pack Quantity
10012/1001	Raised	Yes		12 Pole	180mm	28mm	45A	10
10012L	Level			12 Pole	180mm	22mm	45A	10
10012L/1001	Level	Yes		12 Pole	180mm	22mm	45A	10
10012LT	Level			12 Pole	180mm	22mm	45A	10
10012T	Raised			12 Pole	180mm	28mm	45A	10
10012	Raised			12 Pole	180mm	28mm	45A	10

Approvals



Nominal Clamping Area

10mm²

Nominal Voltage

450V

Max Ambient Temp

85°C

Fire Performance

Halogen Free

Flammability

UL94 - V2 (Nylon material)

Cable glands & terminal blocks

Type 16012 polyamide - terminal block



Type 16012 terminal block

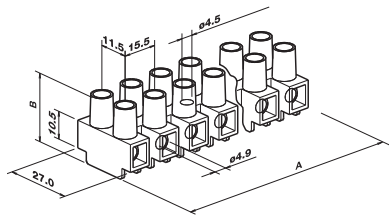

Dimensions

Type 16012 Polyamide - Terminal Block

16mm² Polyamide Terminal Blocks

Materials: Polyamide 6, Galvanised Brass Inserts & Galvanised Steel Screws / **Colour:** White

Part No.	Base	Wire Protector	'T' Insert	No. Poles	Width A	Height B	Rating	Pack Quantity
16012	Raised			12 Pole	180mm	28mm	60A	10
16012LT	Level			12 Pole	180mm	22mm	60A	10
16012/1601	Raised	Yes		12 Pole	180mm	28mm	60A	10
16012L/1601	Level	Yes		12 Pole	180mm	22mm	60A	10
16012T	Raised			12 Pole	180mm	28mm	60A	10
16012L	Level			12 Pole	180mm	22mm	60A	10

Approvals

Nominal Clamping Area	Nominal Voltage	Max Ambient Temp	Fire Performance	Flammability
16mm ²	450V	85°C	Halogen Free	UL94 - V2 (Nylon material)





Aquasafe

Waterproof plugs & connectors

Aquasafe

Introduction	7/3
In-Line Aqua-safe	7/4
Bulkhead Aqua-safe	7/4
Sealing Caps	7/5



Aquasafe

Introduction

Range overview - In-Line (IP68 - 16A)

The in-line range is typically used where temporary connections are required for power. The range offers a variety of cable acceptances sizes, whilst maintaining a compact working envelope.

Aquasafe is suitable for temporary immersion to IP68 2 Bar for 30 minutes (Note: Not submersible). The housings are defined as either Female or Male. The Female housing has the collar moulding, and the Male housing is smaller in diameter, and fits inside the opposite housing. The inner connectors are defined as either a Plug or Socket according to the metal inserts.

Bulkheads (IP68 - 16A)

If power is being distributed and controlled from a fixed installation, it may be more appropriate to mount products into an enclosure or electrical equipment. As an alternative to the in-line connector, Adaptaflex offer complimentary mounting options including;

- **Chassis / panel mounting** (screwed)
Supplied with M25 Locknut and Sealing Washer as standard, the thread has flats to orientate the housing during installation.
- **Bulkhead / surface mounting** (flanged)
Flanged to suit surface mounting where space is restricted behind the application.

Each bulkhead / panel mounted housing can be used in conjunction with the appropriate mating in-line connector.



Sealing Caps (IP68)

Sealing caps can be fitted to each individual housing to maintain protection when the connectors are separated. This ensures electrical safety at all times, even when the connectors are not in use. The caps are operated in exactly the same manner as the connectors, by the latch mechanism held within the collar. A strap is also provided to retain the sealing cap onto the housings, for light static applications.



Aquasafe

In-Line Aqua-safe



In-Line Aqua-Safe

In-Line Aqua-safe

IP68 - 16A Standard In-Line Product

Materials: Plug & Socket Connector: Polycarbonate, Outer Housing: Glass Filled Nylon with Nitrile Rubber Seal / **Colour:** Black

Part No.	Description	Connector Details	Cable Range	Pack Quantity
185-9000	In-Line Waterproof Connector Assembly	3 Pole Plug & Socket	5-9mm	1
185-9100	In-Line Waterproof Connector Assembly	3 Pole Plug & Socket	8-13mm	1
185-9200	In-Line Waterproof Connector Assembly	3 Pole Plug & Socket	12-16mm	1
185-0A1011-P030-1	In-Line Waterproof Female Housing	3 Pole Plug	5-9mm	1
185-0A1021-P030-1	In-Line Waterproof Female Housing	3 Pole Plug	8-13mm	1
185-0A1031-P030-1	In-Line Waterproof Female Housing	3 Pole Plug	12-16mm	1
185-1A1011-S030-1	In-Line Waterproof Male Housing	3 Pole Socket	5-9mm	1
185-1A1021-S030-1	In-Line Waterproof Male Housing	3 Pole Socket	8-13mm	1
185-1A1031-S030-1	In-Line Waterproof Male Housing	3 Pole Socket	12-16mm	1

Approvals



IP Rating

IP68 Yes (upto 2 bar 30min)

Note: Not submersible

Temperature Range

Static Applications: -25°C to +80°C

Halogen Free

Yes

Flammability

UL94 - V2



Bulkhead Aqua-safe
Bulkhead Male Screwed



Bulkhead Aqua-safe
Bulkhead Female Screwed



Bulkhead Aqua-safe
Bulkhead Male Flanged



Bulkhead Aqua-safe
Bulkhead Female Flanged

Bulkhead Aqua-safe

IP68 - 16A Standard Bulkhead Product

Materials: Plug & Socket Connector: Polycarbonate, Outer Housing: Glass Filled Nylon with Nitrile Rubber Seal / **Colour:** Black

Part No.	Description	Connector Details	Pack Quantity
185-0B1000-P030-1	Aqua-safe Bulkhead Female Housing	Flanged 3 Pole Plug	1
185-0E1000-P030-1	Aqua-safe Bulkhead Female Housing	Screwed 3 Pole Plug	1
185-1B1000-S030-1	Aqua-safe Bulkhead Male Housing	Flanged 3 Pole Socket	1
185-1E1000-S030-1	Aqua-safe Bulkhead Male Housing	Screwed 3 Pole Socket	1

Approvals



IP Rating

IP68 Yes (upto 2 bar 30min)

Note: Not submersible

Temperature Range

Static Applications: -25°C to +80°C

Halogen Free

Yes

Flammability

UL94 - V2

Aquasafe Sealing Caps



Female Sealing Cap



Male Sealing Cap

Sealing Caps

IP68 - 16A Sealing Caps

Colour: Black

Part No.	Description	Pack Quantity
185-6100	Male Sealing Cap with strap to suit all Female Housings	100
185-6200	Female Sealing Cap with strap to suit all Male Housings	100



Technical section

Product characteristics, classification & performance

Technical Section

Thread Data	8/2
EMI Screen System & Fire Performance	8/3
IP Ratings & Fitting Characteristics	8/4
Chemical Resistance	8/6
Cable Carrying Capacity (Wire Fill)	8/8
IEC61386 Classifications	8/9

Technical section

Thread data

Metric Thread Data

Standard Thread Conforming to EN60423 & BS3643

Thread Size	External Thread Outside Diameter	Internal Thread Inside Diameter	Pitch
M8	8mm	6.9mm	1mm
M10	10mm	8.9mm	1mm
M12	12mm	10.9mm	1mm
M12	12mm	10.4mm	1.5mm
M16	16mm	14.4mm	1.5mm
M18	18mm	16.9mm	1mm
M20	20mm	18.4mm	1.5mm
M25	25mm	23.4mm	1.5mm
M30	30mm	28.4mm	1.5mm
M32	32mm	30.4mm	1.5mm
M40	40mm	38.4mm	1.5mm
M50	50mm	48.4mm	1.5mm
M63	63mm	61.4mm	1.5mm
M75	75mm	73.4mm	1.5mm

NOTE: Dimensions are nominal

PG Thread Data

German Standard Thread Conforming to DIN40430

Thread Size	External Thread Outside Diameter	Internal Thread Inside Diameter	Pitch
PG7	12.5mm	11.3mm	1.27mm
PG9	15.2mm	13.9mm	1.41mm
PG11	18.6mm	17.3mm	1.41mm
PG13,5	20.4mm	19.1mm	1.41mm
PG16	22.5mm	21.2mm	1.41mm
PG21	28.3mm	26.8mm	1.59mm
PG29	37mm	35.5mm	1.59mm
PG36	47mm	45.5mm	1.59mm
PG42	54mm	52.5mm	1.59mm
PG48	59.3mm	57.8mm	1.59mm

NOTE: Dimensions are nominal

8

PF Thread Data

Japanese Conduit Thread Conforming to JIS B 0202

Thread Size	External Thread Outside Diameter	Internal Thread Inside Diameter	Pitch
1/4"	13mm		1.34mm
3/8"	16.7mm	15.0mm	1.34mm
1/2"	21.0mm	18.6mm	1.81mm
3/4"	26.4mm	24.1mm	1.81mm
1"	33.3mm	30.3mm	2.31mm
1 1/4"	41.9mm	39.0mm	2.31mm
1 1/2"	47.8mm	44.8mm	2.31mm
2"	59.6mm	56.7mm	2.31mm

NOTE: Dimensions are nominal

NPT Thread Data

US Taper Seal Pipe Thread Conforming to ANSI/ASME B1.20.1 - 1983

Thread Size	External Thread Outside Diameter	Pitch
3/8"	16.7mm	1.14mm
1/2"	21.0mm	1.81mm
3/4"	26.4mm	1.81mm
1"	33.3mm	2.21mm
1 1/4"	41.9mm	2.21mm
1 1/2"	47.8mm	2.21mm
2"	59.6mm	2.21mm

NOTE: Dimensions are nominal

UNEF / UNS Thread Data

American Unified Thread conforming to BS1580

Thread Size	External Thread Outside Diameter	Internal Thread Inside Diameter	Pitch
5/8"	15.9mm	14.7mm	1.06mm
3/4"	19.1mm	17.7mm	1.27mm
13/16"	20.6mm	19.3mm	1.27mm
7/8"	22.2mm	20.9mm	1.27mm
15/16"	23.8mm	22.4mm	1.27mm
1"	25.4mm	24.0mm	1.27mm
1 1/8"	28.6mm	27.0mm	1.41mm
1 3/16"	30.2mm	28.6mm	1.41mm
1 1/4"	31.8mm	30.2mm	1.41mm
1 5/16"	33.3mm	31.8mm	1.41mm
1 3/8"	34.9mm	33.4mm	1.41mm
1 7/16"	36.5mm	35.0mm	1.41mm
1 3/4"	44.5mm	42.9mm	1.41mm
2"	50.8mm	49.3mm	1.59mm
2 1/4"	57.2mm	55.4mm	1.59mm

NOTE: Dimensions are nominal

Technical section

EMI screen system & fire performance

EMI Screen System

For applications where electromagnetic interference is of particular concern we have classified suitable conduit systems by means of symbols. These are related in an ascending scale of performance from Standard EMI Screen (products featuring a stainless steel overbraid) through to High EMI Screen (products featuring a tinned copper overbraid). Contact us for full details.



Standard EMI Screen
Screening Level
40db @ 100MHz



Enhanced EMI Screen
Screening Level
60db @ 100MHz



High EMI Screen
Screening Level
75db @ 100MHz

Fire Performance

Adaptaflex has introduced a set of symbols to help the user specify conduit systems for installations where fire performance is of particular concern.

Each symbol encompasses a range of properties relevant to the high specification materials used in the construction of the conduit.

They are in an ascending scale of performance from Low Fire Hazard (LFH) featuring zero halogen through to Super Low Fire Hazard (SLFH) featuring zero nitrogen. In addition, Inherent Low Fire Hazard systems (ILFH) are classified as being all metal systems.



Low Fire Hazard



Enhanced Low Fire Hazard



Super Low Fire Hazard



Inherent Low Fire Hazard

Property	LFH	ELFH	SLFH	ILFH
Oxygen Index ISO4589	31% ≥ OI ≥ 28%	OI ≥ 32%	OI ≥ 32%	Inherent Low Fire Hazard
BS6853 Smoke Density 3m ³	0.02 ≥ A0 ≥ 0.03	0.005 ≥ A0 ≥ 0.02	0.02 A0 ≤ 0.005	i.e. Type S, SS, SPB
Zero Halogen	•	•	•	STC, SSB & SSBGS
Zero Phosphorus	•	•	•	Metallic Conduit & Fittings
Zero Sulphur	•	•	•	
London Underground	Concession	Approved	Approved	
Toxicity Index NES713 Issue 3	5.0 ≥ TI ≥ 6.0	0.5 ≥ TI ≥ 5.0	TI ≤ 0.5	
NFF16-102	I3F2	I2F2	I2F1	

Technical section







IP ratings & fitting characteristics

IP Ratings

IP suitability ratings are a system for classifying the degree of protection provided by enclosures of electrical equipment.











Protection against Solid Bodies

Degree of protection for persons against access to hazardous parts inside the enclosure and/or against the ingress of solid foreign objects.

	0	No protection
	1	Objects greater than 50 mm, accidental touch by hands
	2	Objects greater than 12 mm, accidental touch by fingers
	3	Objects greater than 2.5 mm, e.g. tools/wires
	4	Objects greater than 1 mm, e.g. tools/wires/small wires
	5	Protected against dust - limited ingress (no harmful deposits)
	6	Totally protected against dust (Dust-tight)

Protection against Water

Degree of protection of equipment inside enclosures against damage from the ingress of water.

	0	No protection
	1	Protected against vertically falling drops of water
	2	Protected against direct sprays of water up to 15° from vertical
	3	Protected against sprays of water to 60° from vertical
	4	Protected against water sprayed from all directions - limited ingress permitted
	5	Protected against low pressure jets of water from all directions - limited ingress permitted
	6	Protected against strong pressure jets of water, heavy seas - limited ingress permitted
	7	Protection against the effects of immersion between 15cm - 1 m
	8	Protection against long periods of immersion under a quoted pressure, e.g. 2 bar at 24 hours
	9	IP69k Automotive standard DIN40050 and signifies resistance to high pressure jets of water (up to 80bar) from any angle

8

IP Ratings

The higher the number, the greater the degree of protection; they apply ONLY to properly installed equipment.
The numerals stand for the following:

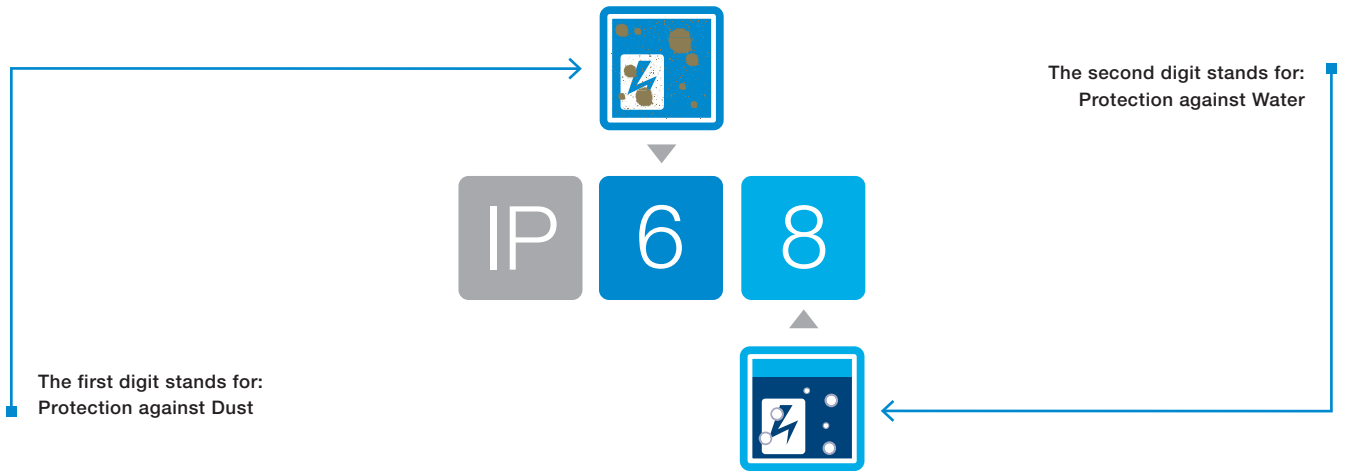

Fitting Characteristics



Fitting swivels independently of conduit for installation purpose but is not suitable as a rotating joint in constantly moving applications.



Fitting rotates independently of the conduit to act as a rotating joint within constantly moving applications.

Technical section

Chemical resistance

Chemical Resistance Comparison Table

Products	PA, PR PADL, SN	PI, PF	GP	KF, RF, SP	PP	PK	Fittings PA66	Elastomer Seal ATS	S (including braid)	SS (including braid)	LFH-SP	SPL, SPUL	SPLHC	TC braid	Fittings nickel plated brass
Astm no.1	●	●	●	■	●	●	●	●	●	●	■	●	●	●	●
Astm no.2	●	●	●	■	●	●	●	●	●	●	▲	●	▲	●	●
Astm no.3	●	●	●	■	▲	●	●	●	●	●	▲	●	▲	●	●
Acetic Acid (10%)	▲	▲	●	▲	●	●	▲	▲	■	●	●	●	●	▲	●
Acetone	●	●	▲	■	●	●	●	▲	●	●	■	■	●	●	●
Aluminium Chloride	▲	●	■	▲	●	●	▲	●	■	▲	●	●	●	▲	NT
Aniline	▲	■	■	■	●	▲	▲	■	●	●	▲	■	●	●	●
Benzaldehyde	▲	▲	▲	■	▲	●	▲	▲	●	●	■	■	▲	●	●
Benzene	●	●	▲	■	▲	●	●	▲	●	●	■	■	■	●	●
Carbon tetrachloride	●	●	■	▲	▲	●	●	▲	●	●	■	▲	▲	●	●
Chlorine Water	■	■	▲	■	▲	■	■	■	■	■	▲	■	●	■	●
Chloroform	■	■	■	■	▲	●	■	▲	●	●	■	■	▲	●	●
Citric acid	●	●	●	●	●	●	●	●	●	●	●	●	●	●	●
Copper sulphate	▲	●	●	●	●	●	▲	●	●	●	●	●	●	●	●
Cresol	■	■	NT	▲	●	▲	■	■	●	●	■	▲	●	▲	●
Diesel oil	●	●	●	▲	●	●	●	●	●	●	▲	●	●	●	●
Diethylamine	●	▲	▲	▲	●	●	●	■	●	●	●	▲	●	●	●
Ethanol	●	▲	●	■	●	●	●	▲	●	●	▲	■	●	●	●
Ether	●	●	NT	▲	●	●	●	●	●	●	■	▲	●	●	●
Ethylamine	●	▲	NT	▲	●	●	●	■	●	●	▲	▲	▲	●	●
Ethylene Glycol	●	●	●	▲	●	●	●	●	■	●	●	▲	●	●	●
Ethyl ethanoate	▲	●	●	■	●	●	▲	■	●	●	■	■	●	●	●
Freon 32	●	●	●	▲	●	●	●	▲	■	●	■	▲	■	●	●
Hydrchloric acid (10%)	■	▲	▲	●	●	●	■	▲	■	■	■	●	●	■	●
Hydrchloric acid (36%)	■	■	■	▲	●	●	■	■	■	■	■	●	●	■	●
Hydrogen peroxide (35%)	▲	▲	▲	●	●	●	▲	■	■	●	▲	●	▲	●	●
Hydrogen peroxide (87%)	■	■	■	●	▲	●	■	■	■	●	■	●	■	▲	●
Lactic acid	▲	●	■	▲	●	●	▲	●	■	●	●	▲	▲	●	●
Lubricating oil	●	●	●	▲	●	●	●	●	●	●	▲	●	▲	●	●
Methanol	▲	▲	●	■	●	●	▲	▲	●	●	▲	■	●	●	●
Methyl bromide	■	■	NT	■	▲	●	■	■	●	●	■	■	▲	●	●
MEK	●	●	▲	■	●	●	●	▲	●	●	■	■	●	●	●
Nitric acid (10%)	■	■	▲	●	●	●	■	■	■	■	●	●	●	■	●
Nitric acid (70%)	■	■	■	●	●	■	■	■	■	■	■	●	●	■	●
Oxalic acid	▲	●	▲	▲	●	●	▲	▲	■	●	●	●	●	▲	●
Ozone (gas)	■	■	NT	▲	▲	●	■	●	■	●	●	▲	▲	●	●
Paraffin oil	●	●	●	▲	●	●	●	●	●	●	▲	●	●	●	●
Petrol	●	●	●	■	●	●	●	●	●	●	■	●	●	●	●
Phenol	■	■	■	▲	●	▲	■	▲	●	●	■	▲	●	▲	●

Chemical Resistance Comparison Table

Products	PA, PR PAUL, SN	PI, PF	GP	KF, RF, SP	PP	PK	Fittings PA66	Elastomer Seal ATS	S (including braid)	SS (including braid)	LPH-SP	SP, SPUL	SPLHC	TC braid	Fittings nickel plated brass
Chemical															
Sea water	●	●	●	●	●	●	●	●	■	●	●	●	●	●	▲
Silver nitrate	●	●	NT	●	●	●	●	●	■	●	●	●	●	●	●
Skydrol	●	●	●	■	●	●	●	▲	●	●	■	■	●	●	●
Sodium chloride	●	●	●	●	●	●	●	●	■	●	●	●	●	●	▲
Sodium hydroxide (10%)	●	●	●	●	●	●	●	●	■	●	●	●	●	●	●
Sodium hydroxide (60%)	●	▲	■	▲	●	●	●	▲	■	▲	●	●	●	●	●
Sulphur dioxide (gas)	■	■	▲	●	●	●	■	■	■	■	▲	●	●	▲	■
Sulphuric acid (10%)	■	▲	●	●	●	●	■	▲	■	■	●	●	●	■	■
Sulphuric acid (70%)	■	■	■	●	●	■	■	■	■	■	▲	●	●	■	■
Toluene	●	●	▲	■	●	●	●	■	●	●	▲	■	■	●	●
Transformer oil	●	●	●	▲	●	●	●	●	●	●	▲	●	▲	●	●
1,1,1-Trichloroethane	●	●	▲	■	▲	●	●	▲	■	●	▲	■	▲	●	●
Trichloroethylene	▲	■	■	■	▲	●	▲	▲	■	●	▲	■	■	●	●
Turpentine	●	●	●	▲	■	●	●	▲	●	●	■	▲	■	●	●
Vegetable oil	●	●	●	▲	●	●	●	●	●	●	▲	●	●	●	●
Vinyl acetate	▲	●	NT	■	●	●	▲	■	■	●	■	■	●	●	●
Water	●	●	●	●	●	●	●	●	■	●	●	●	●	●	●
White spirit	●	●	NT	▲	●	●	●	▲	●	●	■	▲	▲	●	●
Zinc chloride	■	●	▲	●	●	●	■	●	■	●	●	●	●	▲	●

Note

The information above is given as a guide only and is based on published technical data and experience.

The chemical resistance of the above products is dependant on factors such as chemical exposure, concentration of the chemical and temperature. The above chemicals are valid for a temperature of 23°C.

Use of the above table is at the users own discretion and risk. Those using it must satisfy themselves that their application presents no health and safety risks.

The end user should assess compatibility with their application and contact Adaptaflex for further information.

Key

- Suitable: ●
- Limited suitability: ▲
- Unsuitable: ■
- Not tested: NT

Technical section

Cable carrying capacity (wire fill)

Introduction

UK Wiring regulations BS7671 recommend that the total cross sectional area of the sum of individual cables shall not exceed 40% of the cross sectional area of the conduit based on using 3 or more cables. The tables below enable you to calculate the number of conductors that can be run within a piece of flexible conduit.

Instructions

- **Step 1:** Establish the number and size of each wire to be run in the conduit
- **Step 2:** Look on the Cross Sectional Area (CSA) chart (table 1), look up the CSA taken up by each of the wires from STEP 1
- **Step 3:** Add all the CSA values together (Total CSA)
- **Step 4:** Look on the conduit fill value chart (table 2).
- Choose a conduit with a 40% fill value higher than the total CSA from STEP 3

Table 1 - Cross Sectional Area (CSA) Chart

Nominal Conductor Size	Number of Wires							
	1	2	3	4	5	10	15	20
1mm	6.6	13.2	19.8	26.4	33	66	99	132
1.5mm	7.6	15.2	22.8	30.4	38	76	114	152
2.5mm	9.6	19.2	28.8	38.4	48	96	144	192
4mm	14.5	29	43.5	58	72.5	145	217.5	290
6mm	18.8	37.6	56.4	75.2	94	188	282	376
10mm	29.3	58.6	87.9	117.2	146.5	293	439.5	586
16mm	40.2	80.4	120.6	160.8	201	402	603	804
25mm	63.8	127.6	191.4	255.2	319	638	957	1276
35mm	83.5	167	250.5	334	417.5	835	1252	1670
50mm	113	226	339	452	565	1130	1695	2260
70mm	149	298	447	596	745	1490	2235	
95mm	204	408	612	816	1020	2040		

Table 2 - Wire Fill of Plastic & Metallic Conduit

Nominal Diameter	Plastic Conduit		Metallic Conduit	
	100% Fill	40% Fill	100% Fill	40% Fill
10mm	33.2	13	25.5	10.2
13mm	72.4	29	58.1	23.2
16mm	109.4	44	83.3	33.3
18mm	158.4	63	160.6	64.2
21mm	213.8	86	243.3	97.3
28mm	369.8	148	452.4	181
34mm	602.6	241	855.3	342.1
42mm	973.1	390	1164.2	465.7
54mm	1698.2	680	1963.5	785.4
80mm	3520	1410	3473.2	1389.3
106mm	6500	2600		

Example - What size of conduit to use?

- **Step 1:** 4 x 2.5mm conductors, 2 x 10mm conductors and 3 x 50mm conductors
- **Step 2:** The CSA of Four 2.5mm conductors is 38.4, Two 10mm conductors is 58.6, Three 50mm conductors is 339
- **Step 3:** Total of these groups is 38.4 + 58.6 + 339 = 436
- **Step 4:** Using Table 2 the conduit is either 54mm (680) Plastic or 50mm (465.7) Metallic

- **Note:** 42mm Plastic is 390 which is smaller than 436 therefore not recommended

The information given above relates to PA - Standard weight conduit and Adaptalok fittings or SPL with M-Type fittings. It is given in good faith and should be used only as a guide in conjunction with the relevant wiring regulations.

Technical section

IEC61386 classifications

Non-metallic - IEC61386 Classifications Table

Products	With Fitting	Compression Strength	Impact Strength	Minimum Temperature	Maximum Temperature	Bending Properties	Electrical Properties	IP Rating Solids	IP Rating Water	Corrosion Resistance	Tensile Strength	Non-Flame Propogating	Suspended Load Capacity
Non-metallic Conduit													
PA LIGHT	AT	2	4	2	4	4	0	6	7		1	1	0
PA STANDARD	AT	2	4	2	4	4	0	6	7		1	1	0
PA HEAVY	AT	2	4	2	4	4	0	6	7		2	1	0
PF STANDARD	AT	1	3	5	4	4	0	6	7		1	1	0
PF HEAVY	AT	2	4	5	4	4	0	6	7		1	1	0
PI STANDARD	AT	1	3	5	4	4	0	6	7		1	1	0
PI HEAVY	AT	2	4	5	4	4	0	6	7		1	1	0
PR	AT	2	4	2	4	4	0	6	7		1	1	0
CP	AT	1	4	4	5	4	0	6	7		1	1	0
KF LIGHT	KC	2	2	2	1	2	2	4	0		1	1	0
KF STANDARD	KC	2	3	2	1	2	2	4	0		2	1	0
KF MEDIUM	KC	3	3	2	1	2	2	4	0		1	1	0
PK	PK	2	4	5	6	4	2	6	7		1	1	0
PKTC	PB	2	4	5	6	4	3	6	7		3	1	0
PKSS	PB	2	4	5	6	4	3	6	7		3	1	0
PRTC	PB	2	4	2	4	4	1	6	7		3	1	0
PRSS	PB	2	4	2	4	4	1	6	7		3	1	0
PRSS	PB	2	4	2	4	4	1	6	7		3	1	0

8

Metallic - IEC61386 Classifications Table

Metallic Conduit													
S	S	4	4	5	6	4	0	4	0	1	4	1	5
SS	S	4	4	5	6	4	0	4	0	4	4	1	5
SP	SP(M)	4	4	2	2	4	2	6	5		4	1	5
SN	SP(M)	4	4	4	5	4	0	6	5		4	1	5
LFH-SP	SP(M)	4	4	2	3	4	0	6	5		4	1	5
SPL AL	SPL(M)	4	4	2	3	4	2	6	7		4	1	5
SPLHC	SPL(M)	4	4	5	5	4	0	6	7		4	1	5
SB	SB	4	5	5	6	4	1	4	0	1	4	1	5
STC	SB	4	4	5	6	4	1	4	0	1	4	1	5
SSB	SB	4	4	5	6	4	1	4	0	4	4	1	5
SSBGS	SB	4	4	5	6	4	1	4	0	1	4	1	5
SPB	SPB	4	4	2	2	4	3	5	4		4	1	5
SPTC	SPB	4	4	2	2	4	3	5	4		4	1	5
SPLHCB	SPLB	4	4	5	5	4	1	6	7		5	1	5

Performance Classification Key

Classification Level	(N)	(J)	(°C)	(°C)						(N)	(N)	(N)
0						Not declared		0	N/A	Not declared		Not declared
1	125	0.5	5	60	Rigid	Conductor		1	Low	100	4	20
2	320	1	-5	90	Pliable	Insulator		2	Medium	250	7	30
3	750	2	-15	105	Pliable/ Semi Rigid	Con/Ins	3	3	Med-Hi	500		150
4	1250	6	-25	120	Flexible		4	4	High	1000		450
5	4000	20	-45	150			5	5		2500		850
6				250			6	6				
7								7				

Index

Order code classification

Part No.	GID No.	Page	Part No.	GID No.	Page	Part No.	GID No.	Page
10012/1001	7TCA296220R0001	6/11	6012/601E	7TCA296230R0134	6/11	AL13/PG9/45/BL	7TCA296000R0250	2/14
1512/151E	7TCA296230R0015	6/10	6012L/601E	7TCA296230R0136	6/11	AL13/PG9/A/BL	7TCA296000R0253	2/12
1512LE	7TCA296230R0016	6/10	6012LE	7TCA296230R0137	6/11	AL13/PG9/C90/BL	7TCA296000R0259	2/13
1512LTE	7TCA296230R0017	6/10	6012TE	7TCA296230R0138	6/11	AL13/PG9/CS90/BL	7TCA296000R0263	2/18
1512TE	7TCA296230R0018	6/10	ACB10	7TCA296000R0038	2/52	AL13/PG9/CSF90/BL	7TCA296000R0265	2/20
16012L	7TCA296220R0055	6/12	ACB13	7TCA296000R0041	2/52	AL13/PG9/SA/BL	7TCA296000R0266	2/18
16012L/1601	7TCA296220R0056	6/12	ACB13/ST	7TCA296000R0044	2/52	AL13/PG9/SFA/BL	7TCA296000R0269	2/19
16012T	7TCA296220R0057	6/12	ACB16	7TCA296000R0048	2/52	AL13/U063/45/000620	7TCA296000R0272	2/23
185-0A1011-P031-1	7TCA296210R0001	7/4	ACB16/ST	7TCA296000R0052	2/52	AL13/U063/A/000620	7TCA296000R0274	2/21
185-0A1021-P030-1	7TCA296210R0003	7/4	ACB21	7TCA296000R0056	2/52	AL13/U063/C90/000620	7TCA296000R0275	2/22
185-0A1031-P030-1	7TCA296210R0004	7/4	ACB21/ST	7TCA296000R0060	2/52	AL13/U075/45/000620	7TCA296000R0277	2/23
185-0B1000-P030-1	7TCA296210R0005	7/4	ACB28	7TCA296000R0064	2/52	AL13/U075/A/000620	7TCA296000R0278	2/21
185-0E1000-P030-1	7TCA296210R0007	7/4	ACB28/ST	7TCA296000R0066	2/52	AL13/U075/C90/000620	7TCA296000R0279	2/22
185-0E1000-S030-1	7TCA296210R0010	7/4	ACB34	7TCA296000R0070	2/52	AL13/U088/45/000620	7TCA296000R0281	2/23
185-1A1011-S030-1	7TCA296210R0012	7/4	ACB34/ST	7TCA296000R0072	2/52	AL13/U088/A/000620	7TCA296000R0282	2/21
185-1A1021-S030-1	7TCA296210R0013	7/4	ACB42	7TCA296000R0076	2/52	AL13/U088/C90/000620	7TCA296000R0283	2/22
185-1A1031-S030-1	7TCA296210R0014	7/4	ACB42/ST	7TCA296000R0078	2/52	AL131010/Y/BL	7TCA296000R0285	2/15
185-1B1000-P030-1	7TCA296210R0015	7/4	ACB54	7TCA296000R0082	2/52	AL13RT	7TCA296050R0016	2/53
185-1B1000-S030-1	7TCA296210R0016	7/4	ACB54/ST	7TCA296000R0084	2/52	AL16/038/A/BL	7TCA296000R0295	2/12
185-1E1000-P030-1	7TCA296210R0017	7/4	ACG10	7TCA296000R0088	2/52	AL16/038/C90/BL	7TCA296000R0301	2/13
185-1E1000-S030-1	7TCA296210R0020	7/4	ACG13	7TCA296000R0090	2/52	AL16/050/A/BL	7TCA296000R0312	2/12
185-6100	7TCA296210R0029	7/5	ACG16	7TCA296000R0091	2/52	AL16/050/C90/BL	7TCA296000R0318	2/13
185-6200	7TCA296210R0033	7/5	ACG21	7TCA296000R0093	2/52	AL16/A/U/BL	7TCA296000R0332	2/17
185-9000	7TCA296210R0047	7/4	ACG28	7TCA296000R0097	2/52	AL16/FL/45/BL	7TCA296000R0334	2/16
185-9100	7TCA296210R0049	7/4	ACG34	7TCA296000R0100	2/52	AL16/FL/A/BL	7TCA296000R0335	2/16
185-9200	7TCA296210R0052	7/4	ACG42	7TCA296000R0103	2/52	AL16/FL/C90/BL	7TCA296000R0337	2/16
200-8160	7TCA296220R0059	6/5	ACG54	7TCA296000R0106	2/52	AL16/KM20/A/BL	7TCA296000R0340	2/14
200-8240	7TCA296220R0061	6/5	ADC106/FL/A/BL	7TCA296000R0114	2/24	AL16/M16/45/BL	7TCA296000R0345	2/14
200-8320	7TCA296220R0064	6/5	ADC80/FL/A/BL	7TCA296000R0123	2/24	AL16/M16/A/BL	7TCA296000R0350	2/12
200-8400	7TCA296220R0066	6/5	AL10/M12/A/BL	7TCA296000R0134	2/12	AL16/M16/C90/BL	7TCA296000R0361	2/13
200-8560	7TCA296220R0068	6/5	AL10/M12/C90/BL	7TCA296000R0137	2/13	AL16/M16/CS90/BL	7TCA296000R0366	2/18
200-8640	7TCA296220R0070	6/5	AL10/PF025/A/BL	7TCA296000R0141	2/12	AL16/M16/CSF90/BL	7TCA296000R0368	2/20
200-8720	7TCA296220R0072	6/5	AL10/PG7/A/BL	7TCA296000R0143	2/12	AL16/M16/PPA/BL	7TCA296000R0370	2/48
200-8720	7TCA296220R0072	6/5	AL10/PG7/C90/BL	7TCA296000R0148	2/13	AL16/M16/S45/BL	7TCA296000R0371	2/19
201-8240	7TCA296220R0083	6/5	AL10/PG9/A/BL	7TCA296000R0154	2/12	AL16/M16/SA/BL	7TCA296000R0373	2/18
260-1000	7TCA296230R0059	6/7	AL13/038/A/BL	7TCA296000R0163	2/12	AL16/M16/SF45/BL	7TCA296000R0375	2/20
260-1050	7TCA296230R0060	6/7	AL13/038/C90/BL	7TCA296000R0168	2/13	AL16/M16/SFA/BL	7TCA296000R0377	2/19
260-1100	7TCA296230R0061	6/7	AL13/A/U/BL	7TCA296000R0179	2/17	AL16/M20/45/BL	7TCA296000R0380	2/14
260-1150	7TCA296230R0062	6/7	AL13/FL/C90/BL	7TCA296000R0181	2/16	AL16/M20/A/BL	7TCA296000R0384	2/12
260-1200	7TCA296230R0063	6/7	AL13/M16/45/BL	7TCA296000R0184	2/14	AL16/M20/C90/BL	7TCA296000R0390	2/13
260-1250	7TCA296230R0064	6/7	AL13/M16/A/BL	7TCA296000R0188	2/12	AL16/PF038/A/BL	7TCA296000R0397	2/12
260-1300	7TCA296230R0065	6/7	AL13/M16/C90/BL	7TCA296000R0195	2/13	AL16/PF038/C90/BL	7TCA296000R0399	2/13
260-1350	7TCA296230R0066	6/7	AL13/M16/CS90/BL	7TCA296000R0199	2/18	AL16/PF050/A/BL	7TCA296000R0401	2/12
260-1400	7TCA296230R0067	6/7	AL13/M16/CSF90/BL	7TCA296000R0201	2/20	AL16/PF050/C90/BL	7TCA296000R0404	2/13
260-1450	7TCA296230R0068	6/7	AL13/M16/PPA/BL	7TCA296000R0202	2/48	AL16/PG11/45/BL	7TCA296000R0406	2/14
260-1550	7TCA296230R0071	6/7	AL13/M16/S45/BL	7TCA296000R0203	2/19	AL16/PG11/A/BL	7TCA296000R0412	2/12
260-1650	7TCA296230R0073	6/7	AL13/M16/SA/BL	7TCA296000R0205	2/18	AL16/PG11/CS90/BL	7TCA296000R0422	2/18
260-1700	7TCA296230R0074	6/7	AL13/M16/SF45/BL	7TCA296000R0208	2/20	AL16/PG11/CSF90/BL	7TCA296000R0425	2/20
260-1750	7TCA296230R0075	6/7	AL13/M16/SFA/BL	7TCA296000R0210	2/19	AL16/PG11/S45/BL	7TCA296000R0427	2/19
260-1800	7TCA296230R0076	6/7	AL13/M20/A/BL	7TCA296000R0212	2/12	AL16/PG11/SA/BL	7TCA296000R0429	2/18
4012/401E	7TCA296230R0118	6/10	AL13/PF038/A/BL	7TCA296000R0216	2/12	AL16/PG11/SF45/BL	7TCA296000R0434	2/20
4012LE	7TCA296230R0119	6/10	AL13/PF038/C90/BL	7TCA296000R0219	2/13	AL16/PG11/SFA/BL	7TCA296000R0436	2/19
4012LT/402E	7TCA296230R0120	6/10	AL13/PG11/A/BL	7TCA296000R0223	2/13	AL16/PG13/45/BL	7TCA296000R0438	2/14
4012TE	7TCA296230R0122	6/10	AL13/PG13/A/BL	7TCA296000R0237	2/12	AL16/PG13/A/BL	7TCA296000R0443	2/12

Part No.	GID No.	Page	Part No.	GID No.	Page	Part No.	GID No.	Page
AL16/PG13/C90/BL	7TCA296000R0450	2/13	AL21/PG13/CSF90/BL	7TCA296000R0654	2/20	AL28/M25/CSF90/BL	7TCA296000R0817	2/20
AL16/PG16/A/BL	7TCA296000R0462	2/12	AL21/PG13/S45/BL	7TCA296000R0656	2/19	AL28/M25/PPA/BL	7TCA296000R0819	2/48
AL16/PG9/A/BL	7TCA296000R0471	2/12	AL21/PG13/SA/BL	7TCA296000R0658	2/18	AL28/M25/S45/BL	7TCA296000R0820	2/19
AL16/PG9/C90/BL	7TCA296000R0476	2/13	AL21/PG13/SF45/BL	7TCA296000R0660	2/20	AL28/M25/SA/BL	7TCA296000R0822	2/18
AL16/U063/45/000620	7TCA296000R0481	2/23	AL21/PG13/SFA/BL	7TCA296000R0662	2/19	AL28/M25/SF45/BL	7TCA296000R0826	2/20
AL16/U063/A/000620	7TCA296000R0482	2/21	AL21/PG16/45/BL	7TCA296000R0664	2/14	AL28/M25/SFA/BL	7TCA296000R0828	2/19
AL16/U063/C90/000620	7TCA296000R0483	2/22	AL21/PG16/A/BL	7TCA296000R0674	2/12	AL28/M32/A/BL	7TCA296000R0832	2/12
AL16/U075/45/000620	7TCA296000R0486	2/23	AL21/PG16/C90/BL	7TCA296000R0682	2/13	AL28/PF075/A/BL	7TCA296000R0837	2/12
AL16/U075/A/000620	7TCA296000R0487	2/21	AL21/PG16/CS90/BL	7TCA296000R0686	2/18	AL28/PF075/C90/BL	7TCA296000R0840	2/13
AL16/U075/C90/000620	7TCA296000R0488	2/22	AL21/PG16/CSF90/BL	7TCA296000R0689	2/20	AL28/PG21/45/BL	7TCA296000R0843	2/14
AL16/U081/45/000620	7TCA296000R0489	2/23	AL21/PG16/S45/BL	7TCA296000R0691	2/19	AL28/PG21/A/BL	7TCA296000R0851	2/12
AL16/U081/A/000620	7TCA296000R0490	2/21	AL21/PG16/SA/BL	7TCA296000R0693	2/18	AL28/PG21/C90/BL	7TCA296000R0860	2/13
AL16/U081/C90/000620	7TCA296000R0491	2/22	AL21/PG16/SF45/BL	7TCA296000R0699	2/20	AL28/PG21/CS90/BL	7TCA296000R0864	2/18
AL16/U088/45/000620	7TCA296000R0492	2/23	AL21/PG16/SFA/BL	7TCA296000R0701	2/19	AL28/PG21/CSF90/BL	7TCA296000R0867	2/20
AL16/U088/A/000620	7TCA296000R0493	2/21	AL21/U075/45/000620	7TCA296000R0705	2/23	AL28/PG21/S45/BL	7TCA296000R0871	2/19
AL16/U088/C90/000620	7TCA296000R0495	2/22	AL21/U075/A/000620	7TCA296000R0707	2/21	AL28/PG21/SA/BL	7TCA296000R0873	2/18
AL16/U094/45/000620	7TCA296000R0496	2/23	AL21/U075/C90/000620	7TCA296000R0708	2/22	AL28/PG21/SF45/BL	7TCA296000R0878	2/20
AL16/U094/A/000620	7TCA296000R0497	2/21	AL21/U088/45/000620	7TCA296000R0709	2/23	AL28/PG21/SFA/BL	7TCA296000R0880	2/19
AL16/U094/C90/000620	7TCA296000R0498	2/22	AL21/U088/A/000620	7TCA296000R0710	2/21	AL28/U088/45/000620	7TCA296000R0883	2/23
AL16/U100/45/000620	7TCA296000R0499	2/23	AL21/U088/C90/000620	7TCA296000R0711	2/22	AL28/U088/A/000620	7TCA296000R0884	2/21
AL16/U100/A/000620	7TCA296000R0500	2/21	AL21/U094/45/000620	7TCA296000R0712	2/23	AL28/U088/C90/000620	7TCA296000R0885	2/22
AL16/U100/C90/000620	7TCA296000R0501	2/22	AL21/U094/A/000620	7TCA296000R0713	2/21	AL28/U094/45/000620	7TCA296000R0886	2/23
AL16/U119/45/000620	7TCA296000R0502	2/23	AL21/U094/C90/000620	7TCA296000R0714	2/22	AL28/U094/A/000620	7TCA296000R0887	2/21
AL16/U119/A/000620	7TCA296000R0503	2/21	AL21/U100/45/000620	7TCA296000R0715	2/23	AL28/U094/C90/000620	7TCA296000R0888	2/22
AL16/U119/C90/000620	7TCA296000R0504	2/22	AL21/U100/A/000620	7TCA296000R0716	2/21	AL28/U100/45/000620	7TCA296000R0889	2/23
AL16/U131/45/000620	7TCA296000R0505	2/23	AL21/U100/C90/000620	7TCA296000R0717	2/22	AL28/U100/A/000620	7TCA296000R0890	2/21
AL16/U131/A/000620	7TCA296000R0506	2/21	AL21/U113/45/000620	7TCA296000R0719	2/23	AL28/U100/C90/000620	7TCA296000R0891	2/22
AL16/U131/C90/000620	7TCA296000R0507	2/22	AL21/U113/A/000620	7TCA296000R0720	2/21	AL28/U119/45/000620	7TCA296000R0892	2/23
AL161313/Y/BL	7TCA296000R0508	2/15	AL21/U113/C90/000620	7TCA296000R0721	2/22	AL28/U119/A/000620	7TCA296000R0893	2/21
AL16RT	7TCA296050R0019	2/53	AL21/U119/45/000620	7TCA296000R0722	2/23	AL28/U119/C90/000620	7TCA296000R0894	2/22
AL21/050/A/BL	7TCA296000R0541	2/12	AL21/U119/A/000620	7TCA296000R0723	2/21	AL28/U138/45/000620	7TCA296000R0895	2/23
AL21/A/U/BL	7TCA296000R0561	2/17	AL21/U119/C90/000620	7TCA296000R0724	2/22	AL28/U138/A/000620	7TCA296000R0896	2/21
AL21/FL/45/BL	7TCA296000R0562	2/17	AL21/U131/45/000620	7TCA296000R0726	2/23	AL28/U138/C90/000620	7TCA296000R0897	2/22
AL21/FL/A/BL	7TCA296000R0564	2/16	AL21/U131/A/000620	7TCA296000R0727	2/21	AL28/U144/45/000620	7TCA296000R0898	2/23
AL21/FL/C90/BL	7TCA296000R0568	2/16	AL21/U131/C90/000620	7TCA296000R0728	2/22	AL28/U144/A/000620	7TCA296000R0899	2/21
AL21/KM20/A/BL	7TCA296000R0573	2/14	AL21/U138/45/000620	7TCA296000R0729	2/23	AL28/U144/C90/000620	7TCA296000R0900	2/22
AL21/M20/45/BL	7TCA296000R0578	2/14	AL21/U138/A/000620	7TCA296000R0730	2/21	AL28/U175/45/000620	7TCA296000R0902	2/23
AL21/M20/A/BL	7TCA296000R0585	2/12	AL21/U138/C90/000620	7TCA296000R0731	2/22	AL28/U175/A/000620	7TCA296000R0903	2/21
AL21/M20/C90/BL	7TCA296000R0596	2/13	AL21/U144/45/000620	7TCA296000R0732	2/23	AL28/U175/C90/000620	7TCA296000R0904	2/22
AL21/M20/CS90/BL	7TCA296000R0604	2/18	AL21/U144/A/000620	7TCA296000R0733	2/21	AL28/U200/45/000620	7TCA296000R0906	2/23
AL21/M20/CSF90/BL	7TCA296000R0607	2/20	AL21/U144/C90/000620	7TCA296000R0734	2/22	AL28/U200/A/000620	7TCA296000R0908	2/21
AL21/M20/PPA/BL	7TCA296000R0609	2/48	AL21/U175/45/000620	7TCA296000R0735	2/23	AL28/U200/C90/000620	7TCA296000R0909	2/22
AL21/M20/S45/BL	7TCA296000R0610	2/19	AL21/U175/A/000620	7TCA296000R0736	2/21	AL28/U225/45/000620	7TCA296000R0910	2/23
AL21/M20/SA/BL	7TCA296000R0612	2/18	AL21/U175/C90/000620	7TCA296000R0737	2/22	AL28/U225/C90/000620	7TCA296000R0912	2/22
AL21/M20/SF45/BL	7TCA296000R0615	2/20	AL211616/Y/BL	7TCA296000R0741	2/15	AL282121/Y/BL	7TCA296000R0913	2/15
AL21/M20/SFA/BL	7TCA296000R0617	2/19	AL21RT	7TCA296050R0022	2/53	AL28RT	7TCA296050R0025	2/53
AL21/M25/A/BL	7TCA296000R0620	2/12	AL28/075/A/BL	7TCA296000R0760	2/12	AL34/100/A/BL	7TCA296000R0927	2/12
AL21/PF050/A/BL	7TCA296000R0625	2/12	AL28/075/C90/BL	7TCA296000R0766	2/13	AL34/100/C90/BL	7TCA296000R0933	2/13
AL21/PF050/C90/BL	7TCA296000R0629	2/13	AL28/A/U/BL	7TCA296000R0779	2/17	AL34/A/U/BL	7TCA296000R0945	2/17
AL21/PG11/A/BL	7TCA296000R0631	2/12	AL28/FL/45/BL	7TCA296000R0782	2/16	AL34/FL/90/BL	7TCA296000R0946	2/16
AL21/PG13/45/BL	7TCA296000R0639	2/14	AL28/FL/C90/BL	7TCA296000R0787	2/16	AL34/M32/45/BL	7TCA296000R0950	2/14
AL21/PG13/A/BL	7TCA296000R0643	2/12	AL28/M25/45/BL	7TCA296000R0791	2/14	AL34/M32/A/BL	7TCA296000R0957	2/12
AL21/PG13/C90/BL	7TCA296000R0648	2/13	AL28/M25/A/BL	7TCA296000R0797	2/12	AL34/M32/C90/BL	7TCA296000R0964	2/13
AL21/PG13/CS90/BL	7TCA296000R0651	2/18	AL28/M25/C90/BL	7TCA296000R0807	2/13	AL34/M32/CS90/BL	7TCA296000R0968	2/18

Index

Order code classification

Part No.	GID No.	Page	Part No.	GID No.	Page	Part No.	GID No.	Page
AL34/M32/C90/BL	7TCA296000R0964	2/13	AL42/PG36/SA/BL	7TCA296000R1144	2/18	ALS16/F	7TCA296000R1318	2/15
AL34/M32/CS90/BL	7TCA296000R0968	2/18	AL42/PG36/SF45/BL	7TCA296000R1149	2/20	ALS21/F	7TCA296000R1332	2/15
AL34/M32/CSF90/BL	7TCA296000R0971	2/20	AL42/PG36/SFA/BL	7TCA296000R1151	2/19	ALS28/C	7TCA296000R1345	2/15
AL34/M32/PPA/BL	7TCA296000R0973	2/48	AL42/U175/45/000620	7TCA296000R1154	2/23	ALS34/C	7TCA296000R1356	2/15
AL34/M32/S45/BL	7TCA296000R0974	2/19	AL42/U175/A/000620	7TCA296000R1155	2/21	ALS42/C	7TCA296000R1362	2/15
AL34/M32/SA/BL	7TCA296000R0976	2/18	AL42/U175/C90/000620	7TCA296000R1156	2/22	ALS54/C	7TCA296000R1369	2/15
AL34/M32/SF45/BL	7TCA296000R0980	2/20	AL42/U200/45/000620	7TCA296000R1157	2/23	AR13/M16/A/BL	7TCA296000R1392	2/43
AL34/M32/SFA/BL	7TCA296000R0981	2/19	AL42/U200/A/000620	7TCA296000R1158	2/21	AR13/M16/C90/BL	7TCA296000R2670	2/43
AL34/M40/A/BL	7TCA296000R0983	2/12	AL42/U200/C90/000620	7TCA296000R1159	2/22	AR13/PG9/A/BL	7TCA296000R1393	2/43
AL34/PF100/A/BL	7TCA296000R0988	2/12	AL42RT	7TCA296050R0030	2/53	AR13X3/T/BL	7TCA296000R1394	2/44
AL34/PF100/C90/BL	7TCA296000R0991	2/13	AL54/150/A/BL	7TCA296000R1173	2/12	AR16/M16/A/BL	7TCA296000R1396	2/43
AL34/PG29/45/BL	7TCA296000R0996	2/14	AL54/150/C90/BL	7TCA296000R1179	2/13	AR16/M16/C90/BL	7TCA296000R1399	2/43
AL34/PG29/A/BL	7TCA296000R1002	2/12	AL54/200/C90/BL	7TCA296000R1197	2/13	AR16/M20/A/BL	7TCA296000R1405	2/43
AL34/PG29/C90/BL	7TCA296000R1010	2/13	AL54/A/U/BL	7TCA296000R2671	2/17	AR16/M20/C90/BL	7TCA296000R1406	2/43
AL34/PG29/CS90/BL	7TCA296000R1014	2/18	AL54/FL/45/BL	7TCA296000R1203	2/17	AR16/PG11/A/BL	7TCA296000R1408	2/43
AL34/PG29/S45/BL	7TCA296000R1018	2/19	AL54/FL/A/BL	7TCA296000R1209	2/16	AR16/PG13/A/BL	7TCA296000R1416	2/43
AL34/PG29/SA/BL	7TCA296000R1020	2/18	AL54/M50/45/BL	7TCA296000R1210	2/14	AR16X3/T/BL	7TCA296000R1419	2/44
AL34/PG29/SF45/BL	7TCA296000R1027	2/20	AL54/M50/A/BL	7TCA296000R1213	2/12	AR21/M20/A/BL	7TCA296000R1420	2/43
AL34/PG29/SFA/BL	7TCA296000R1029	2/19	AL54/M50/C90/BL	7TCA296000R1219	2/13	AR21/M20/C90/BL	7TCA296000R1422	2/43
AL34/U100/45/000620	7TCA296000R1031	2/23	AL54/M50/CS90/BL	7TCA296000R1222	2/18	AR21/PG16/A/BL	7TCA296000R1429	2/43
AL34/U100/A/000620	7TCA296000R1032	2/21	AL54/M50/CS90/BL	7TCA296000R1222	2/18	AR21X3/T/BL	7TCA296000R1433	2/44
AL34/U100/C90/000620	7TCA296000R1033	2/22	AL54/M50/CSF90/BL	7TCA296000R1226	2/20	AR28/M25/A/BL	7TCA296000R1437	2/43
AL34/U119/45/000620	7TCA296000R1034	2/23	AL54/M50/CSF90/BL	7TCA296000R1226	2/20	AR28/M25/C90/BL	7TCA296000R1439	2/43
AL34/U119/A/000620	7TCA296000R1035	2/21	AL54/M50/S45/BL	7TCA296000R1227	2/19	AR28/PG21/A/BL	7TCA296000R1446	2/43
AL34/U119/C90/000620	7TCA296000R1036	2/22	AL54/M50/SA/BL	7TCA296000R1229	2/18	AR28X3/T/BL	7TCA296000R1451	2/44
AL34/U144/45/000620	7TCA296000R1037	2/23	AL54/M50/SA/BL	7TCA296000R1229	2/18	AR34/M32/A/BL	7TCA296000R1455	2/43
AL34/U144/A/000620	7TCA296000R1038	2/21	AL54/M50/SF45/BL	7TCA296000R1231	2/20	AR34/M32/C90/BL	7TCA296000R1457	2/43
AL34/U144/C90/000620	7TCA296000R1040	2/22	AL54/M50/SF45/BL	7TCA296000R1231	2/20	AR34/PG29/A/BL	7TCA296000R1462	2/43
AL34/U175/45/000620	7TCA296000R1042	2/23	AL54/M50/SFA/BL	7TCA296000R1232	2/19	AR34X3/T/BL	7TCA296000R1468	2/44
AL34/U175/A/000620	7TCA296000R1043	2/21	AL54/M50/SFA/BL	7TCA296000R1232	2/19	AR42/M40/A/BL	7TCA296000R1470	2/43
AL34/U175/C90/000620	7TCA296000R1044	2/22	AL54/M63/45/BL	7TCA296000R1234	2/14	AR42/M40/C90/BL	7TCA296000R1471	2/43
AL34/U200/45/000620	7TCA296000R1045	2/23	AL54/M63/A/BL	7TCA296000R1236	2/12	AR42/PG36/A/BL	7TCA296000R1472	2/43
AL34/U200/A/000620	7TCA296000R1046	2/21	AL54/M63/C90/BL	7TCA296000R1242	2/13	AR54/M50/A/BL	7TCA296000R1475	2/43
AL34/U200/C90/000620	7TCA296000R1047	2/22	AL54/M63/CS90/BL	7TCA296000R1245	2/18	AR54/M50/C90/BL	7TCA296000R1476	2/43
AL34RT	7TCA296050R0027	2/53	AL54/M63/CS90/BL	7TCA296000R1245	2/18	AR54/PG48/A/BL	7TCA296000R1477	2/43
AL42/125/A/BL	7TCA296000R1056	2/12	AL54/M63/S45/BL	7TCA296000R1247	2/19	ASC21/M20/A/BL	7TCA296000R1483	2/40
AL42/125/C90/BL	7TCA296000R1061	2/13	AL54/M63/S45/BL	7TCA296000R1247	2/19	ASC21/M20/C90/BL	7TCA296000R1486	2/40
AL42/M40/A/BL	7TCA296000R1081	2/12	AL54/M63/SA/BL	7TCA296000R1249	2/18	ASC21/PG16/A/BL	7TCA296000R1495	2/40
AL42/M40/C90/BL	7TCA296000R1087	2/13	AL54/M63/SA/BL	7TCA296000R1249	2/18	ASC21/PG16/C90/BL	7TCA296000R1497	2/40
AL42/M40/CS90/BL	7TCA296000R1091	2/18	AL54/PF150/A/BL	7TCA296000R1256	2/12	ASC21X3/T/BL	7TCA296000R1498	2/41
AL42/M40/CSF90/BL	7TCA296000R1094	2/20	AL54/PF150/C90/BL	7TCA296000R1260	2/13	ASC28/M25/A/BL	7TCA296000R1502	2/40
AL42/M40/S45/BL	7TCA296000R1096	2/19	AL54/PF200/A/BL	7TCA296000R1265	2/12	ASC28/M25/C90/BL	7TCA296000R1504	2/40
AL42/M40/SA/BL	7TCA296000R1098	2/18	AL54/PF200/C90/BL	7TCA296000R1268	2/13	ASC28/PG21/A/BL	7TCA296000R1514	2/40
AL42/M40/SF45/BL	7TCA296000R1102	2/20	AL54/PG48/45/BL	7TCA296000R1272	2/14	ASC28/PG21/C90/BL	7TCA296000R1517	2/40
AL42/M40/SFA/BL	7TCA296000R1103	2/19	AL54/PG48/A/BL	7TCA296000R1278	2/12	ASC28X3/T/BL	7TCA296000R1519	2/41
AL42/M50/A/BL	7TCA296000R1106	2/12	AL54/PG48/C90/BL	7TCA296000R1286	2/13	ASC34/FL/90/BL	7TCA296000R1521	2/41
AL42/PF125/A/BL	7TCA296000R1111	2/12	AL54/PG48/CS90/BL	7TCA296000R1291	2/18	ASC34/M32/A/BL	7TCA296000R1522	2/40
AL42/PF125/C90/BL	7TCA296000R1113	2/13	AL54/PG48/CSF90/BL	7TCA296000R1293	2/20	ASC34/M32/C90/BL	7TCA296000R1525	2/40
AL42/PG36/45/BL	7TCA296000R1117	2/14	AL54/PG48/S45/BL	7TCA296000R1295	2/19	ASC34/PG29/A/BL	7TCA296000R1535	2/40
AL42/PG36/A/BL	7TCA296000R1122	2/12	AL54/PG48/SA/BL	7TCA296000R1296	2/18	ASC34/PG29/C90/BL	7TCA296000R1538	2/40
AL42/PG36/C90/BL	7TCA296000R1130	2/13	AL54/PG48/SF45/BL	7TCA296000R1297	2/20	ASC34X3/T/BL	7TCA296000R1540	2/41
AL42/PG36/CS90/BL	7TCA296000R1136	2/18	AL54/PG48/SFA/BL	7TCA296000R1298	2/19	ASC42/FL/90/BL	7TCA296000R1542	2/41
AL42/PG36/CSF90/BL	7TCA296000R1139	2/20	AL54RT	7TCA296050R0033	2/53	ASC42/M40/A/BL	7TCA296000R1545	2/40
AL42/PG36/S45/BL	7TCA296000R1142	2/19	ALS13/F	7TCA296000R1317	2/15	ASC42/M40/C90/BL	7TCA296000R1548	2/40

Part No.	GID No.	Page
ASC42/PG36/A/BL	7TCA296000R1554	2/40
ASC42/PG36/C90/BL	7TCA296000R1557	2/40
ASC54/FL/90/BL	7TCA296000R1560	2/41
ASC54/M50/A/BL	7TCA296000R1562	2/40
ASC54/M50/C90/BL	7TCA296000R1565	2/40
ASC54/PG48/A/BL	7TCA296000R1571	2/40
ASC54/PG48/C90/BL	7TCA296000R1574	2/40
ASF10/M16/A/BL	7TCA296000R1576	2/40
ASF10/M16/C90/BL	7TCA296000R1577	2/40
ASF10/PG9/A/BL	7TCA296000R1578	2/40
ASF10/PG9/C90/BL	7TCA296000R1580	2/40
ASF10X3/T/BL	7TCA296000R1581	2/41
ASF13/FL/C90/BL	7TCA296000R1583	2/41
ASF13/M16/A/BL	7TCA296000R1586	2/40
ASF13/M16/C90/BL	7TCA296000R1589	2/40
ASF13/PG9/A/BL	7TCA296000R1598	2/40
ASF13/PG9/C90/BL	7TCA296000R1601	2/40
ASF13X3/T/BL	7TCA296000R1603	2/41
ASF16/FL/C90/BL	7TCA296000R1606	2/41
ASF16/M16/A/BL	7TCA296000R1608	2/40
ASF16/M16/C90/BL	7TCA296000R1612	2/40
ASF16/M20/A/BL	7TCA296000R1621	2/40
ASF16/M20/A/BL	7TCA296000R1621	2/40
ASF16/M20/C90/BL	7TCA296000R1624	2/40
ASF16/PG11/A/BL	7TCA296000R1630	2/40
ASF16/PG11/C90/BL	7TCA296000R1635	2/40
ASF16/PG13/A/BL	7TCA296000R1643	2/40
ASF16/PG13/C90/BL	7TCA296000R1647	2/40
ASF16X3/T/BL	7TCA296000R1650	2/41
ASF21/M20/A/BL	7TCA296000R1659	2/40
ASF21/M20/C90/BL	7TCA296000R1664	2/40
ASF21/PG16/A/BL	7TCA296000R1679	2/40
ASF21/PG16/A/BL	7TCA296000R1679	2/40
ASF21/PG16/C90/BL	7TCA296000R1684	2/40
ASF21X3/T/BL	7TCA296000R1687	2/41
ASF28/M25/A/BL	7TCA296000R1692	2/40
ASF28/M25/C90/BL	7TCA296000R1694	2/40
ASF28/PG21/A/BL	7TCA296000R1703	2/40
ASF28/PG21/C90/BL	7TCA296000R1706	2/40
ASF28X3/T/BL	7TCA296000R1709	2/41
ASF34/FL/90/BL	7TCA296000R1711	2/41
ASF34/M32/A/BL	7TCA296000R1714	2/40
ASF34/M32/C90/BL	7TCA296000R1717	2/40
ASF34/PG29/A/BL	7TCA296000R1727	2/40
ASF34/PG29/C90/BL	7TCA296000R1731	2/40
ASF34X3/T/BL	7TCA296000R1733	2/41
AT13/038/A/BLY	7TCA296170R0001	2/27
AT13/038/C90/BLY	7TCA296170R0005	2/28
AT13/038/SA/BLY	7TCA296170R0006	2/30
AT13/A/U/BLY	7TCA296170R0009	2/36
AT13/FL/C90/BLY	7TCA296170R0012	2/37
AT13/M16/45/BLY	7TCA296170R0016	2/29
AT13/M16/A/BLY	7TCA296170R0020	2/27
AT13/M16/C90/BLY	7TCA296170R0026	2/28

Part No.	GID No.	Page
AT13/M16/CSF90/BLB	7TCA296170R0034	2/32
AT13/M16/S45/BLY	7TCA296170R0035	2/31
AT13/M16/SA/BLY	7TCA296170R0037	2/30
AT13/M16/SF45/BLB	7TCA296170R0038	2/32
AT13/M16/SFA/BLY	7TCA296170R0040	2/31
AT13/PF038/A/BLY	7TCA296170R0043	2/27
AT13/PF038/C90/BLY	7TCA296170R0047	2/28
AT13/U063/SFA/BLY	7TCA296170R0049	2/33
AT13/U075/CSF90/BLY	7TCA296170R0050	2/34
AT13/U075/SFA/BLY	7TCA296170R0051	2/33
AT13/U088/CSF90/BLY	7TCA296170R0053	2/34
AT13/U088/SFA/BLY	7TCA296170R0055	2/33
AT16/038/A/BLY	7TCA296170R0061	2/27
AT16/038/C90/BLB	7TCA296170R0064	2/28
AT16/038/S45/BLY	7TCA296000R2667	2/31
AT16/038/SA/BLY	7TCA296170R0066	2/30
AT16/038/SFA/BLY	7TCA296170R0069	2/31
AT16/050/A/BLY	7TCA296170R0072	2/27
AT16/050/C90/BLY	7TCA296170R0078	2/28
AT16/050/S45/BLY	7TCA296170R0081	2/31
AT16/050/SA/BLY	7TCA296170R0082	2/30
AT16/050/SFA/BLY	7TCA296170R0083	2/31
AT16/A/U/BLY	7TCA296170R0085	2/36
AT16/FL/45/BLY	7TCA296170R0089	2/37
AT16/FL/C90/BLY	7TCA296170R0097	2/37
AT16/M16/45/BLY	7TCA296170R0100	2/29
AT16/M16/A/BLY	7TCA296170R0105	2/27
AT16/M16/C90/BLY	7TCA296170R0112	2/28
AT16/M16/CSF90/BLY	7TCA296170R0122	2/32
AT16/M16/S45/BLY	7TCA296170R0125	2/31
AT16/M16/SA/BLY	7TCA296170R0129	2/30
AT16/M16/SF45/BLY	7TCA296170R0134	2/32
AT16/M16/SFA/BLY	7TCA296170R0137	2/31
AT16/M20/45/BLY	7TCA296170R0142	2/29
AT16/M20/A/BLY	7TCA296170R0144	2/27
AT16/M20/C90/BLY	7TCA296170R0152	2/28
AT16/PF038/A/BLY	7TCA296170R0162	2/27
AT16/PF050/A/BLY	7TCA296170R0166	2/27
AT16/PF050/C90/BLY	7TCA296170R0170	2/28
AT16/U063/CSF90/BLY	7TCA296170R0179	2/34
AT16/U063/SFA/BLY	7TCA296170R0180	2/33
AT16/U075/CSF90/BLY	7TCA296170R0181	2/34
AT16/U075/SFA/BLY	7TCA296170R0182	2/33
AT16/U088/CSF90/BLY	7TCA296170R0184	2/34
AT16/U088/SFA/BLY	7TCA296170R0186	2/33
AT16/U100/CSF90/BLY	7TCA296170R0188	2/34
AT16/U100/SFA/BLY	7TCA296170R0190	2/33
AT16/U119/SFA/BLY	7TCA296170R0191	2/33
AT21/050/A/BLY	7TCA296170R0200	2/27
AT21/050/C90/BLY	7TCA296170R0206	2/28
AT21/A/U/BLY	7TCA296170R0225	2/36
AT21/FL/45/BLY	7TCA296170R0229	2/37
AT21/FL/A/BLY	7TCA296170R0233	2/36
AT21/FL/C90/BLY	7TCA296170R0238	2/37

Part No.	GID No.	Page
AT21/M20/45/BLY	7TCA296170R0242	2/29
AT21/M20/A/BLY	7TCA296170R0248	2/27
AT21/M20/C90/BLY	7TCA296170R0256	2/28
AT21/M20/CSF90/BLY	7TCA296170R0268	2/32
AT21/M20/S45/BLY	7TCA296170R0272	2/31
AT21/M20/SA/BLY	7TCA296170R0275	2/30
AT21/M20/SF45/BLY	7TCA296170R0281	2/32
AT21/M20/SFA/BLY	7TCA296170R0284	2/31
AT21/M25/A/BLY	7TCA296170R0291	2/27
AT21/PF050/A/BLY	7TCA296170R0300	2/27
AT21/PF050/C90/BLY	7TCA296170R0304	2/28
AT21/U075/CSF90/BLY	7TCA296170R0314	2/34
AT21/U075/SFA/BLY	7TCA296170R0316	2/33
AT21/U088/SFA/BLY	7TCA296170R0319	2/33
AT21/U094/CSF90/BLY	7TCA296170R0321	2/34
AT21/U094/SFA/BLY	7TCA296170R0324	2/33
AT21/U100/CSF90/BLY	7TCA296170R0326	2/34
AT21/U100/SF45/BLY	7TCA296170R0327	2/35
AT21/U100/SFA/BLY	7TCA296170R0329	2/33
AT21/U113/SF45/BLY	7TCA296170R0330	2/35
AT21/U119/CSF90/BLY	7TCA296170R0332	2/34
AT21/U119/SFA/BLY	7TCA296170R0335	2/33
AT21/U138/CSF90/BLY	7TCA296170R0338	2/34
AT21/U138/SFA/BLY	7TCA296170R0339	2/33
AT21/U144/CSF90/BLY	7TCA296170R0341	2/34
AT21/U144/SFA/BLY	7TCA296170R0343	2/33
AT28/075/A/BLY	7TCA296170R0352	2/27
AT28/075/C90/BLY	7TCA296170R0357	2/28
AT28/075/S45/BLY	7TCA296170R0365	2/31
AT28/075/SA/BLY	7TCA296170R0368	2/30
AT28/075/SFA/BLY	7TCA296170R0371	2/31
AT28/A/U/BLY	7TCA296170R0374	2/36
AT28/FL/45/BLY	7TCA296170R0377	2/37
AT28/FL/A/BLY	7TCA296170R0381	2/36
AT28/FL/C90/BLY	7TCA296170R0385	2/37
AT28/M25/45/BLY	7TCA296170R0389	2/29
AT28/M25/A/BLY	7TCA296170R0396	2/27
AT28/M25/C90/BLY	7TCA296170R0404	2/28
AT28/M25/CSF90/BLY	7TCA296170R0418	2/32
AT28/M25/S45/BLY	7TCA296170R0421	2/31
AT28/M25/SA/BLY	7TCA296170R0425	2/30
AT28/M25/SF45/BLY	7TCA296170R0430	2/32
AT28/M25/SFA/BLY	7TCA296170R0434	2/31
AT28/M32/A/BLY	7TCA296170R0439	2/27
AT28/PF075/A/BLY	7TCA296170R0450	2/27
AT28/PF075/C90/BLY	7TCA296170R0452	2/28
AT28/U100/CSF90/BLY	7TCA296170R0462	2/34
AT28/U100/SFA/BLY	7TCA296170R0463	2/33
AT28/U119/SF45/BLY	7TCA296170R0465	2/35
AT28/U119/SFA/BLY	7TCA296170R0467	2/33
AT28/U138/CSF90/BLY	7TCA296170R0468	2/34
AT28/U138/SF45/BLY	7TCA296170R0469	2/35
AT28/U138/SFA/BLY	7TCA296170R0470	2/33
AT28/U144/CSF90/BLY	7TCA296170R0472	2/34

Index

Order code classification

Part No.	GID No.	Page	Part No.	GID No.	Page	Part No.	GID No.	Page
AT28/PF075/A/BLY	7TCA296170R0450	2/27	AT42/PF125/C90/BLY	7TCA296170R0663	2/28	AWB34	7TCA296050R0075	2/42, 2/44
AT28/PF075/C90/BLY	7TCA296170R0452	2/28	AT48/150/45/BLY	7TCA296170R0673	2/29	B/050/45	7TCA296030R0000	3/29
AT28/U100/CSF90/BLY	7TCA296170R0462	2/34	AT48/150/A/BLY	7TCA296170R0677	2/27	B/050/90	7TCA296030R0001	3/29
AT28/U100/SFA/BLY	7TCA296170R0463	2/33	AT48/150/C90/BLY	7TCA296170R0681	2/28	B/050-M16/TC	7TCA296050R0077	3/30
AT28/U119/SF45/BLY	7TCA296170R0465	2/35	AT48/150/SFA/BLY	7TCA296170R0684	2/31	B/050-M20/TC	7TCA296050R0078	3/30
AT28/U119/SFA/BLY	7TCA296170R0467	2/33	AT48/A/U/BLY	7TCA296170R0686	2/36	B/075/90	7TCA296030R0003	3/29
AT28/U138/CSF90/BLY	7TCA296170R0468	2/34	AT48/PF150/45/BLY	7TCA296170R0706	2/29	B/131U-M20/TC	7TCA296050R0096	3/30
AT28/U138/SF45/BLY	7TCA296170R0469	2/35	AT48/PF150/A/BLY	7TCA296170R0710	2/27	B/M16/45	7TCA296030R0006	3/19
AT28/U138/SFA/BLY	7TCA296170R0470	2/33	AT48/PF150/C90/BLY	7TCA296170R0714	2/28	B/M16/90	7TCA296030R0007	3/29
AT28/U144/CSF90/BLY	7TCA296170R0472	2/34	AT54/150/CS90/BLY	7TCA296170R0720	2/30	B/M16/C	7TCA296050R0110	3/29
AT28/U144/SF45/BLY	7TCA296170R0473	2/35	AT54/150/S45/BLY	7TCA296170R0722	2/31	B/M16-M12/R	7TCA296050R0103	3/30
AT28/U144/SFA/BLY	7TCA296170R0475	2/33	AT54/200/C90/BLY	7TCA296170R0731	2/28	B/M16-M20/E	7TCA296050R0104	3/30
AT28/U175/CSF90/BLY	7TCA296170R0476	2/34	AT54/200/S45/BLY	7TCA296170R0738	2/31	B/M16-PG11/TC	7TCA296050R0107	3/30
AT34/100/45/BLY	7TCA296170R0483	2/29	AT54/200/SA/BLY	7TCA296170R0741	2/30	B/M16-PG7/TC	7TCA296050R0108	3/30
AT34/100/A/BLY	7TCA296170R0486	2/27	AT54/200/SFA/BLY	7TCA296170R0743	2/31	B/M16-PG9/TC	7TCA296050R0109	3/30
AT34/100/C90/BLY	7TCA296170R0491	2/28	AT54/A/U/BLY	7TCA296170R0745	2/36	B/M20/45	7TCA296030R0009	3/19
AT34/100/S45/BLY	7TCA296170R0496	2/31	AT54/FL/45/BLY	7TCA296170R0748	2/37	B/M20/90	7TCA296030R0011	3/29
AT34/100/SA/BLY	7TCA296170R0498	2/30	AT54/M50/45/BLY	7TCA296170R0750	2/29	B/M20/C	7TCA296050R0132	3/29
AT34/100/SF45/BLY	7TCA296170R0501	2/32	AT54/M50/A/BLY	7TCA296170R0754	2/27	B/M20-050/TC	7TCA296050R0111	3/30
AT34/100/SFA/BLY	7TCA296170R0503	2/31	AT54/M50/C90/BLY	7TCA296170R0758	2/28	B/M20-M12/R	7TCA296050R0113	3/30
AT34/A/U/BLY	7TCA296170R0505	2/36	AT54/M50/CSF90/BLY	7TCA296170R0763	2/32	B/M20-M16/R	7TCA296050R0114	3/30
AT34/M32/45/BLY	7TCA296170R0509	2/29	AT54/M50/S45/BLY	7TCA296170R0765	2/31	B/M20-M25/E	7TCA296050R0118	3/30
AT34/M32/A/BLY	7TCA296170R0514	2/27	AT54/M50/SA/BLY	7TCA296170R0767	2/30	B/M20-PG11/TC	7TCA296050R0121	3/30
AT34/M32/C90/BLY	7TCA296170R0522	2/28	AT54/M50/SF45/BLY	7TCA296170R0769	2/32	B/M20-PG13/TC	7TCA296050R0124	3/30
AT34/M32/CSF90/BLY	7TCA296170R0532	2/32	AT54/M63/A/BLY	7TCA296170R0774	2/27	B/M20-PG16/TC	7TCA296050R0126	3/30
AT34/M32/S45/BLY	7TCA296170R0534	2/31	AT54/M63/C90/BLY	7TCA296170R0779	2/28	B/M20-PG7/TC	7TCA296050R0130	3/30
AT34/M32/SA/BLY	7TCA296170R0536	2/30	AT54/M63/S45/BLY	7TCA296170R0788	2/31	B/M20-PG9/TC	7TCA296050R0131	3/30
AT34/M32/SF45/BLY	7TCA296170R0542	2/32	AT54/M63/SA/BLY	7TCA296170R0790	2/30	B/M25/45	7TCA296030R0013	3/19
AT34/M32/SFA/BLY	7TCA296170R0545	2/31	AT54/M63/SFA/BLY	7TCA296170R0793	2/31	B/M25/90	7TCA296030R0014	3/29
AT34/M40/A/BLY	7TCA296170R0551	2/27	AT54/PF200/A/BLY	7TCA296170R0796	2/27	B/M25/C	7TCA296050R0142	3/29
AT34/PF100/A/BLY	7TCA296170R0561	2/27	AT54/PF200/C90/BLY	7TCA296170R0798	2/28	B/M25-M20/R	7TCA296050R0135	3/29
AT34/PF100/C90/BLY	7TCA296170R0565	2/28	AT211316/T/BLY	7TCA296170R0882	2/38	B/M25-M32/E	7TCA296050R0138	3/29
AT34/U100/SFA/BLY	7TCA296170R0860	2/33	AT211321/T/BLY	7TCA296170R0883	2/38	B/M25-PG21/TC	7TCA296050R0140	3/30
AT34/U119/SFA/BLY	7TCA296170R0577	2/33	AT211613/T/BLY	7TCA296170R0884	2/38	B/M32/45	7TCA296030R0015	3/19
AT34/U144/CSF90/BLY	7TCA296170R0579	2/34	AT212116/T/BLY	7TCA296170R0885	2/38	B/M32/90	7TCA296030R0016	3/29
AT34/U144/SFA/BLY	7TCA296170R0582	2/33	AT212121/T/BLY	7TCA296170R0348	2/38	B/M32/C	7TCA296050R0147	3/29
AT42/125/45/BLY	7TCA296170R0865	2/29	AT212113/T/BLY	7TCA296170R0347	2/38	B/M32-M25/R	7TCA296050R0145	3/29
AT42/125/A/BLY	7TCA296170R0588	2/27	AT211616/T/BLY	7TCA296170R0346	2/38	B/M32-PG29/TC	7TCA296050R0146	3/30
AT42/125/C90/BLY	7TCA296170R0593	2/28	AT212121/T/BLY	7TCA296170R0348	2/38	B/M40/C	7TCA296050R0149	3/29
AT42/125/CSF90/BLY	7TCA296170R0597	2/32	AT281321/T/BLY	7TCA296170R0886	2/38	B/M40-M32/R	7TCA296050R0148	3/29
AT42/125/S45/BLY	7TCA296170R0599	2/31	AT281328/T/BLY	7TCA296170R0887	2/38	B/M50/C	7TCA296050R0151	3/29
AT42/125/SA/BLY	7TCA296170R0601	2/30	AT281621/T/BLY	7TCA296170R0888	2/38	B/M50-M40/R	7TCA296050R0150	3/29
AT42/125/SFA/BLY	7TCA296170R0605	2/31	AT281628/T/BLY	7TCA296170R0480	2/38	B/M63/C	7TCA296050R0152	3/29
AT42/A/U/BLY	7TCA296170R0609	2/36	AT282121/T/BLY	7TCA296170R0889	2/38	B/M75/C	7TCA296050R0153	3/29
AT42/M40/45/BLY	7TCA296170R0613	2/29	AT282128/T/BLY	7TCA296170R0890	2/38	B/PG11/90	7TCA296030R0019	3/29
AT42/M40/A/BLY	7TCA296170R0618	2/27	AT282828/T/BLY	7TCA296170R0873	2/38	B/PG11-050/TC	7TCA296050R0154	3/31
AT42/M40/C90/BLY	7TCA296170R0625	2/28	AT341634/T/BLY	7TCA296170R0891	2/38	B/PG11-M16/TC	7TCA296050R0155	3/30
AT42/M40/CSF90/BLY	7TCA296170R0635	2/32	AT342128/T/BLY	7TCA296170R0892	2/38	B/PG11-M20/TC	7TCA296050R0159	3/30
AT42/M40/S45/BLY	7TCA296170R0638	2/31	AT342134/T/BLY	7TCA296170R0893	2/38	B/PG11-PG13/E	7TCA296050R0162	3/30
AT42/M40/SA/BLY	7TCA296170R0640	2/30	AT343434/T/BLB	7TCA296170R0918	2/38	B/PG11-PG16/E	7TCA296050R0165	3/30
AT42/M40/SF45/BLY	7TCA296170R0644	2/32	AWB13	7TCA296050R0071	2/42, 2/44	B/PG11-PG7/R	7TCA296050R0166	3/30
AT42/M40/SFA/BLY	7TCA296170R0647	2/31	AWB16	7TCA296050R0072	2/42, 2/44	B/PG11-PG9/R	7TCA296050R0167	3/30
AT42/M50/A/BLY	7TCA296170R0653	2/27	AWB21	7TCA296050R0073	2/42, 2/44	B/PG13/90	7TCA296030R0021	3/29
AT42/PF125/A/BLY	7TCA296170R0660	2/27	AWB28	7TCA296050R0074	2/42, 2/44	B/PG13-M16/TC	7TCA296050R0168	3/30

Part No.	GID No.	Page
B/PG13-M20/TC	7TCA296050R0170	3/30
B/PG13-PG11/R	7TCA296050R0173	3/30
B/PG13-PG16/E	7TCA296050R0174	3/30
B/PG13-PG21/E	7TCA296050R0175	3/30
B/PG13-PG9/R	7TCA296050R0177	3/30
B/PG16/90	7TCA296030R0023	3/29
B/PG16-M16/TC	7TCA296050R0179	3/30
B/PG16-M20/TC	7TCA296050R0180	3/30
B/PG16-M25/TC	7TCA296050R0184	3/30
B/PG16-PG11/R	7TCA296050R0185	3/30
B/PG16-PG13/R	7TCA296050R0186	3/30
B/PG16-PG21/E	7TCA296050R0189	3/30
B/PG21/45	7TCA296030R0024	3/29
B/PG21/90	7TCA296030R0025	3/29
B/PG21-M16/TC	7TCA296050R0195	3/30
B/PG21-M20/TC	7TCA296050R0196	3/30
B/PG21-M25/TC	7TCA296050R0199	3/30
B/PG21-M32/TC	7TCA296050R0202	3/30
B/PG21-PG11/R	7TCA296050R0203	3/30
B/PG21-PG16/R	7TCA296050R0205	3/30
B/PG21-PG29/E	7TCA296050R0208	3/30
B/PG29-M20/TC	7TCA296050R0209	3/30
B/PG29-M25/TC	7TCA296050R0210	3/30
B/PG29-M32/TC	7TCA296050R0211	3/30
B/PG29-M40/TC	7TCA296050R0214	3/30
B/PG29-PG16/R	7TCA296050R0215	3/30
B/PG29-PG21/R	7TCA296050R0216	3/30
B/PG29-PG36/E	7TCA296050R0219	3/31
B/PG36-M32/TC	7TCA296050R0220	3/30
B/PG36-M40/TC	7TCA296050R0223	3/30
B/PG36-PG21/R	7TCA296050R0224	3/30
B/PG36-PG29/R	7TCA296050R0225	3/30
B/PG42-PG29/R	7TCA296050R0230	3/30
B/PG42-PG36/R	7TCA296050R0231	3/31
B/PG48-PG42/R	7TCA296050R0235	3/31
B/PG7-M16/TC	7TCA296050R0237	3/30
B/PG7-M20/TC	7TCA296050R0239	3/30
B/PG7-PG9/E	7TCA296050R0240	3/30
B/PG9/90	7TCA296030R0026	3/29
B/PG9-M16/TC	7TCA296050R0241	3/30
B/PG9-M20/TC	7TCA296050R0243	3/30
B/PG9-PG11/E	7TCA296050R0245	3/30
B/PG9-PG13/E	7TCA296050R0246	3/30
B/PG9-PG7/R	7TCA296050R0247	3/30
CP-AF20A	7TCA296180R0006	4/2
CP-AF20BS	7TCA296180R0014	4/2
CP-AF20BS-PP	7TCA296180R0015	4/2
CP-AF20SP-BS	7TCA296180R0022	4/2
CP-AF25A	7TCA296180R0028	4/2
CP-AF25BS	7TCA296180R0035	4/2
CP-AF25BS-PP	7TCA296180R0036	4/2
CPCM28/BL/50M	7TCA296000R1760	2/10
CPCM34/BL/50M	7TCA296000R1761	2/10
CPCM42/BL/50M	7TCA296000R1763	2/10

Part No.	GID No.	Page
CPFM13/BL/50M	7TCA296000R1765	2/10
CPFM16/BL/50M	7TCA296000R1766	2/10
CPFM21/BL/50M	7TCA296000R1767	2/10
CP-KF20BS	7TCA296180R0042	4/2
CP-KF25BS	7TCA296180R0045	4/2
CUT-VICE	7TCA296050R0252	5/3
ECB13	7TCA296000R1786	2/53
ECB16	7TCA296000R1789	2/53
ECB21	7TCA296000R1792	2/53
ECB28	7TCA296000R1795	2/53
ECB34	7TCA296000R1798	2/53
ECB42	7TCA296000R1801	2/53
ECB54	7TCA296000R1804	2/53
ESM12-10B	7TCA296250R0004	6/5
ESM16-11B	7TCA296250R0013	6/5
ESM20-12B	7TCA296250R0027	6/5
ESM25-14B	7TCA296250R0053	6/5
ESM32-15B	7TCA296250R0067	6/5
FK20/BL	7TCA296170R0837	2/54
GZ11	7TCA296050R0262	2/53
GZ13	7TCA296050R0263	2/53
GZ21	7TCA296050R0265	2/53
GZ29	7TCA296050R0266	2/53
GZ36	7TCA296050R0267	2/53
GZ9	7TCA296050R0268	2/53
KC16/M16/A/BL	7TCA296090R0001	2/46
KC16/M16/C90/BL	7TCA296090R0003	2/46
KC16/M20/A/BL	7TCA296090R0004	2/46
KC20/M20/A/BL	7TCA296090R0006	2/46
KC20/M20/C90/BL	7TCA296090R0007	2/46
KC25/M25/A/BL	7TCA296090R0010	2/46
KF16/M16/A/BL	7TCA296140R0013	2/47
KF20/M20/A/BL	7TCA296130R0000	2/47
KF25/M25/A/BL	7TCA296140R0023	2/47
KFL16/50M	7TCA296090R0020	2/45
KFL20/50M	7TCA296140R0028	2/45
KFL25/50M	7TCA296090R0025	2/45
KFM16/50M	7TCA296090R0026	2/45
KFM20/50M	7TCA296140R0030	2/45
KFM25/50M	7TCA296090R0027	2/45
KFS16/W/50M	7TCA296140R0035	2/45
KFS20/W/50M	7TCA296140R0038	2/45
KFS25/W/50M	7TCA296140R0040	2/45
KWIKCUT	7TCA296050R0278	5/2
LFH-SP12/50M	7TCA296130R0003	3/10
LFH-SP16/50M	7TCA296130R0005	3/10
LFH-SP25/25M	7TCA296130R0011	3/10
LFH-SP25/25M	7TCA296130R0011	3/10
LFH-SP32/25M	7TCA296130R0015	3/10
LFH-SP40/25M	7TCA296130R0018	3/10
LFH-SP50/10M	7TCA296130R0019	3/10
LFH-SP63/25M	7TCA296130R0022	3/10
LFH-SP75/10M	7TCA296130R0028	3/10
LFH-SPL16/25M	7TCA296030R0402	3/14

Part No.	GID No.	Page
LFH-SPL16/10M	7TCA296030R0401	3/14
LFH-SPL20/10M	7TCA296030R0403	3/14
LFH-SPL20/25M	7TCA296030R0404	3/14
LFH-SPL25/10M	7TCA296030R0405	3/14
LFH-SPL25/25M	7TCA296030R0406	3/14
LFH-SPL32/10M	7TCA296030R0407	3/14
LFH-SPL32/25M	7TCA296030R0408	3/14
LFH-SPL40/10M	7TCA296030R0409	3/14
LFH-SPL50/10M	7TCA296030R0410	3/14
LFH-SPL63/10M	7TCA296030R0411	3/14
LNB/M12	7TCA296050R0288	3/28
LNB/M16	7TCA296050R0290	3/28
LNB/M20	7TCA296050R0293	3/28
LNB/M25	7TCA296050R0299	3/28
LNB/M32	7TCA296050R0304	3/28
LNB/M40	7TCA296050R0307	3/28
LNB/M50	7TCA296050R0309	3/28
LNB/M63	7TCA296050R0311	3/28
LNB/M75	7TCA296050R0313	3/28
LNB/PG11	7TCA296050R0316	3/28
LNB/PG13	7TCA296050R0317	3/28
LNB/PG16	7TCA296050R0318	3/28
LNB/PG21	7TCA296050R0319	3/28
LNB/PG29	7TCA296050R0320	3/28
LNB/PG36	7TCA296050R0321	3/28
LNB/PG42	7TCA296050R0323	3/28
LNB/PG48	7TCA296050R0324	3/28
LNB/PG7	7TCA296050R0326	3/28
LNB/PG9	7TCA296050R0327	3/28
LNPB/M12	7TCA296000R1854	2/52
LNPB/M16	7TCA296000R1855	2/52
LNPB/M20	7TCA296000R1856	2/52
LNPB/M25	7TCA296000R1857	2/52
LNPB/M32	7TCA296000R1858	2/52
LNPB/M40	7TCA296000R1859	2/52
LNPB/M50	7TCA296000R1860	2/52
LNPB/M63	7TCA296050R0329	2/52
LNPB/PG11	7TCA296050R0330	2/52
LNPB/PG13	7TCA296050R0331	2/52
LNPB/PG16	7TCA296050R0332	2/52
LNPB/PG21	7TCA296050R0333	2/52
LNPB/PG29	7TCA296050R0334	2/52
LNPB/PG36	7TCA296050R0335	2/52
LNPB/PG48	7TCA296050R0337	2/52
LNPB/PG7	7TCA296050R0338	2/52
LNPB/PG9	7TCA296050R0339	2/52
LNPB/M16	7TCA296000R1861	2/52
LNPB/M20	7TCA296000R1862	2/52
LNPB/M25	7TCA296000R1863	2/52
LNPB/M32	7TCA296000R1864	2/52
LNPB/M40	7TCA296000R1865	2/52
LNPB/M50	7TCA296220R0535	2/52
LNPB/PG11	7TCA296050R0341	2/52
LNPB/PG13	7TCA296050R0342	2/52

Index

Order code classification

Part No.	GID No.	Page	Part No.	GID No.	Page	Part No.	GID No.	Page
PAC54/BL/50M	7TCA296000R2039	2/7	PFCS42/BL/50M	7TCA296000R2279	2/8	PSA16/M30	7TCA296050R0420	3/28
PAC80/BL/10M	7TCA296000R2047	2/7	PFCS54/BL/50M	7TCA296000R2281	2/8	RF12/BL/30M	7TCA296150R0000	2/49
PADL17/BL/50M	7TCA296000R2057	2/11	PFFH13/BL/50M	7TCA296000R2282	2/8	RF16/BL/30M	7TCA296150R0001	2/49
PADL21/BL/50M	7TCA296000R2744	2/11	PFFH16/BL/50M	7TCA296000R2283	2/8	RF16/M16/A/BL	7TCA296060R0048	2/51
PADL28/BL/50M	7TCA296000R2063	2/11	PFFS10/BL/50M	7TCA296000R2284	2/8	RF16/M20/A/BL	7TCA296060R0050	2/51
PADL34/BL/50M	7TCA296000R2066	2/11	PFFS13/BL/50M	7TCA296000R2285	2/8	RF20/GR/30M	7TCA296060R0063	2/49
PADL42/BL/25M	7TCA296000R2068	2/11	PFFS16/BL/50M	7TCA296000R2286	2/8	RF20/M20/A/BL	7TCA296060R0065	2/51
PAFH13/BL/50M	7TCA296000R2072	2/7	PFFS21/BL/50M	7TCA296000R2287	2/8	RF20/M20/C90/BL	7TCA296060R0066	2/51
PAFH16/BL/50M	7TCA296000R2077	2/7	PICH21/BL/50M	7TCA296000R2300	2/9	RF25/BL/30M	7TCA296060R0073	2/49
PAFL13/BL/50M	7TCA296000R2093	2/6	PICH28/BL/50M	7TCA296000R2308	2/9	RF25/M25/A/BL	7TCA296060R0075	2/51
PAFL13/BL/50M	7TCA296000R2093	2/6	PICH34/BL/50M	7TCA296000R2313	2/9	RF25/M25/C90/BL	7TCA296060R0076	2/51
PAFL13-S/BL/50M	7TCA296000R2088	2/6	PICS106/BL/10M	7TCA296000R2324	2/9	RF32/BL/30M	7TCA296060R0083	2/49
PAFL16/BL/50M	7TCA296000R2107	2/6	PICS28/BL/50M	7TCA296000R2327	2/9	RF32/M32/A/BL	7TCA296060R0085	2/51
PAFL16/BL/50M	7TCA296000R2107	2/6	PICS34/BL/50M	7TCA296000R2341	2/9	RF32/M32/C90/BL	7TCA296060R0086	2/51
PAFL16-S/BL/50M	7TCA296000R2102	2/6	PICS42/BL/50M	7TCA296000R2355	2/9	RK13-10	7TCA296000R2510	2/42
PAFL21/BL/50M	7TCA296000R2125	2/6	PICS80/BL/10M	7TCA296000R2368	2/9	RK16-10	7TCA296000R2512	2/42
PAFL21/BL/50M	7TCA296000R2125	2/6	PIFH16/BL/50M	7TCA296000R2381	2/9	RK16-13	7TCA296000R2513	2/42
PAFL21-S/BL/50M	7TCA296000R2120	2/6	PIFS10/BL/50M	7TCA296000R2389	2/9	RK21-10	7TCA296000R2515	2/42
PAFS10/BL/50M	7TCA296000R2143	2/7	PIFS13/BL/50M	7TCA296000R2396	2/9	RK21-13	7TCA296050R0429	2/42
PAFS13/BL/50M	7TCA296000R2155	2/7	PIFS16/BL/50M	7TCA296000R2404	2/9	RK21-16	7TCA296050R0430	2/42
PAFS16/BL/50M	7TCA296000R2176	2/7	PIFS21/BL/50M	7TCA296000R2411	2/9	RK28-13	7TCA296000R2517	2/42
PAFS21/BL/50M	7TCA296000R2207	2/7	PK13/M16/A	7TCA296100R0077	2/57	RK28-16	7TCA296050R0432	2/42
PAFS28/BL/50M	7TCA296000R2234	2/7	PK16/M16/A	7TCA296100R0078	2/57	RK28-21	7TCA296000R2519	2/42
PAFS34/BL/50M	7TCA296000R2251	2/7	PK21/M20/A	7TCA296100R0079	2/57	RK34-21	7TCA296000R2520	2/42
PBC28/M25/A	7TCA296100R0024	2/61	PK28/M25/A	7TCA296100R0080	2/57	RK34-28	7TCA296000R2521	2/42
PBC28/M25/B	7TCA296100R0025	2/61	PK34/M32/A	7TCA296100R0081	2/57	ROTCUT	7TCA296050R0437	5/3
PBC34/M32/A	7TCA296100R0030	2/61	PKCS28/BL/25M	7TCA296100R0082	2/57	S10/25M	7TCA296010R0007	3/6
PBC34/M32/B	7TCA296100R0031	2/61	PKCS34/BL/50M	7TCA296100R0085	2/57	S10/9/C	7TCA296010R0010	3/8
PBC42/M40/A	7TCA296100R0036	2/61	PKFS13/BL/50M	7TCA296100R0095	2/57	S10/M12/A	7TCA296010R0013	3/7
PBC42/M40/B	7TCA296100R0037	2/61	PKFS16/BL/50M	7TCA296100R0097	2/57	S10/M12/B	7TCA296010R0014	3/7
PBC54/M50/A	7TCA296100R0039	2/61	PKFS21/BL/50M	7TCA296100R0101	2/57	S10/PG7/A	7TCA296010R0015	3/7
PBC54/M50/B	7TCA296100R0040	2/61	PKFSS13/BL/25M	7TCA296100R0102	2/58	S10/PG7/B	7TCA296010R0016	3/7
PBF16/M16/A	7TCA296100R0044	2/60	PPFM13/BL/50M	7TCA296000R2441	2/48	S12/12/C	7TCA296010R0021	3/8
PBF16/M16/B	7TCA296100R0045	2/60	PPFM16/BL/50M	7TCA296000R2447	2/48	S12/25M	7TCA296010R0022	3/6
PBF21/M20/A	7TCA296100R0051	2/60	PPFM21/BL/50M	7TCA296000R2453	2/48	S12/M16/A	7TCA296010R0026	3/7
PBF21/M20/B	7TCA296100R0052	2/60	PPFM28/BL/50M	7TCA296000R2461	2/48	S12/M16/B	7TCA296010R0027	3/7
PCLIP/10	7TCA296050R0389	3/28	PPFM34/BL/50M	7TCA296000R2465	2/48	S12/PG9/A	7TCA296010R0029	3/7
PCLIP/12	7TCA296050R0392	3/28	PRCS21/BL/50M	7TCA296000R2472	2/10	S12/PG9/B	7TCA296720R0000	3/7
PCLIP/16	7TCA296050R0395	3/28	PRCS28/BL/50M	7TCA296000R2476	2/10	S16/16/C	7TCA296010R0035	3/8
PCLIP/16SS	7TCA296050R0540	3/28	PRCS34/BL/50M	7TCA296000R2483	2/10	S16/50M	7TCA296010R0040	3/6
PCLIP/20	7TCA296050R0398	3/28	PRCS42/BL/25M	7TCA296000R2488	2/10	S16/M16/A	7TCA296010R0043	3/7
PCLIP/20SS	7TCA296050R0541	3/28	PRCS54/BL/25M	7TCA296000R2491	2/10	S16/M16/B	7TCA296010R0045	3/7
PCLIP/25	7TCA296050R0401	3/28	PRCSS28/BL/25M	7TCA296100R0117	2/61	S16/M20/A	7TCA296010R0049	3/7
PCLIP/25SS	7TCA296050R0542	3/28	PRCSS34/BL/25M	7TCA296100R0122	2/61	S16/M20/B	7TCA296010R0052	3/7
PCLIP/32	7TCA296050R0404	3/28	PRCSTC28/BL/50M	7TCA296100R0129	2/61	S16/PG11/A	7TCA296010R0054	3/7
PCLIP/40	7TCA296050R0407	3/28	PRFS13/BL/50M	7TCA296000R2498	2/10	S16/PG11/B	7TCA296010R0055	3/7
PCLIP/50	7TCA296050R0411	3/28	PRFS16/BL/50M	7TCA296000R2503	2/10	S20/20/C	7TCA296010R0062	3/8
PCLIP/63	7TCA296050R0414	3/28	PRFS21/BL/50M	7TCA296000R2507	2/10	S20/25M	7TCA296010R0063	3/6
PCLIP/75	7TCA296050R0416	3/28	PRFSS16/BL/50M	7TCA296100R0137	2/59	S20/M20/A	7TCA296010R0070	3/7
PFCH21/BL/50M	7TCA296000R2269	2/8	PRFSS21/BL/25M	7TCA296100R0138	2/59	S20/M20/B	7TCA296010R0074	3/7
PFCH28/BL/50M	7TCA296000R2270	2/8	PRFSTC16/BL/50M	7TCA296100R0140	2/59	S20/M20/F	7TCA296010R0078	3/8
PFCH34/BL/50M	7TCA296000R2272	2/8	PRFSTC21/BL/50M	7TCA296100R0142	2/59	S20/PG16/A	7TCA296010R0080	3/7
PFCS28/BL/50M	7TCA296000R2275	2/8	PSA16/M12	7TCA296050R0418	3/28	S20/PG16/B	7TCA296010R0081	3/7
PFCS34/BL/50M	7TCA296000R2277	2/8	PSA16/M18	7TCA296050R0419	3/28	S25/25/C	7TCA296010R0091	3/8

Part No.	GID No.	Page
S25/25M	7TCA296010R0092	3/6
S25/M25/A	7TCA296010R0098	3/7
S25/M25/B	7TCA296010R0102	3/7
S25/M25/F	7TCA296010R0106	3/8
S25/PG21/A	7TCA296010R0107	3/7
S25/PG21/B	7TCA296010R0108	3/7
S32/32/C	7TCA296010R0120	3/8
S32/50M	7TCA296010R0121	3/6
S32/M32/A	7TCA296010R0123	3/7
S32/M32/B	7TCA296010R0127	3/7
S32/M32/F	7TCA296010R0130	3/8
S32/PG29/A	7TCA296010R0131	3/7
S32/PG29/B	7TCA296010R0132	3/7
S40/25M	7TCA296010R0140	3/6
S40/40/C	7TCA296010R0142	3/8
S40/M40/A	7TCA296010R0146	3/7
S40/M40/B	7TCA296010R0148	3/7
S40/PG36/A	7TCA296010R0150	3/7
S50/10M	7TCA296010R0154	3/6
S50/51/C	7TCA296010R0160	3/8
S50/M50/A	7TCA296010R0161	3/7
S50/M50/B	7TCA296010R0162	3/7
S63/61/C	7TCA296010R0173	3/8
S63/M63/A	7TCA296010R0174	3/7
S75/10M	7TCA296010R0187	3/6
S75/75/C	7TCA296020R0019	3/8
S75/M75/A	7TCA296010R0190	3/7
SB10/25M	7TCA296040R0014	3/21
SB10/M12/A	7TCA296040R0016	3/23
SB10/M12/B	7TCA296020R0020	3/23
SB12/25M	7TCA296040R0021	3/21
SB12/M16/A	7TCA296040R0024	3/23
SB12/M16/B	7TCA296040R0025	3/23
SB16/25M	7TCA296040R0031	3/21
SB16/M16/A	7TCA296040R0033	3/23
SB16/M16/B	7TCA296040R0034	3/23
SB20/25M	7TCA296040R0040	3/21
SB20/M20/A	7TCA296040R0043	3/23
SB20/M20/B	7TCA296040R0045	3/23
SB25/25M	7TCA296040R0051	3/21
SB25/M25/A	7TCA296040R0054	3/23
SB25/M25/B	7TCA296040R0056	3/23
SB32/25M	7TCA296040R0063	3/21
SB32/M32/A	7TCA296040R0067	3/23
SB32/M32/B	7TCA296040R0069	3/23
SB40/25M	7TCA296040R0074	3/21
SB40/M40/A	7TCA296040R0076	3/23
SB40/M40/B	7TCA296040R0077	3/23
SB50/10M	7TCA296040R0080	3/21
SB50/M50/A	7TCA296040R0083	3/23
SB50/M50/B	7TCA296040R0084	3/23
SB63/10M	7TCA296040R0089	3/21
SB63/M63/A	7TCA296040R0090	3/23
SB75/10M	7TCA296040R0091	3/21

Part No.	GID No.	Page
SB75/M75/A	7TCA296040R0093	3/23
SK106	7TCA296050R0444	2/24
SK80	7TCA296050R0454	2/24
SN16/BL/50M	7TCA296130R0036	3/9
SN20/BL/50M	7TCA296130R0040	3/9
SN25/BL/25M	7TCA296130R0043	3/9
SP10/9/C	7TCA296020R0024	3/8
SP10/BL/25M	7TCA296020R0027	3/9
SP10/M12/A	7TCA296020R0036	3/10
SP10/M12/B	7TCA296020R0037	3/11
SP10/PG7/A	7TCA296020R0039	3/10
SP10/PG7/B	7TCA296020R0041	3/11
SP12/12/C	7TCA296020R0044	3/8
SP12/M16/A	7TCA296020R0057	3/10
SP12/M16/B	7TCA296020R0059	3/11
SP12/M16/M	7TCA296020R0061	3/12
SP12/PG9/A	7TCA296020R0068	3/10
SP12/PG9/B	7TCA296020R0069	3/11
SP12/PG9/M	7TCA296020R0071	3/12
SP16/BL/50M	7TCA296020R0084	3/9
SP16/E	7TCA296020R0088	3/13
SP16/M16/A	7TCA296020R0093	3/10
SP16/M16/B	7TCA296020R0095	3/11
SP16/M16/C90	7TCA296020R0098	3/11
SP16/M16/M	7TCA296020R0100	3/12
SP16/M20/A	7TCA296020R0102	3/10
SP16/M20/B	7TCA296020R0105	3/11
SP16/M20/C90	7TCA296020R0108	3/11
SP16/M20/M	7TCA296020R0109	3/12
SP16/PG11/M	7TCA296020R0118	3/12
SP16/PG13/M	7TCA296020R0121	3/12
SP20/050/M	7TCA296020R0128	3/12
SP20/20/C	7TCA296020R0129	3/13
SP20/BL/25M	7TCA296020R0138	3/9
SP20/E	7TCA296020R0145	3/13
SP20/M20/A	7TCA296020R0149	3/10
SP20/M20/B	7TCA296020R0153	3/11
SP20/M20/C90	7TCA296020R0157	3/11
SP20/M20/F	7TCA296020R0158	3/12
SP20/M20/M	7TCA296020R0159	3/12
SP20/PG16/A	7TCA296020R0163	3/10
SP20/PG16/B	7TCA296020R0165	3/11
SP20/PG16/M	7TCA296020R0170	3/12
SP25/075/M	7TCA296020R0174	3/12
SP25/25/C	7TCA296020R0176	3/13
SP25/BL/50M	7TCA296020R0186	3/9
SP25/E	7TCA296020R0189	3/13
SP25/M25/A	7TCA296020R0194	3/10
SP25/M25/B	7TCA296020R0198	3/11
SP25/M25/C90	7TCA296020R0202	3/11
SP25/M25/F	7TCA296020R0203	3/13
SP25/M25/M	7TCA296020R0204	3/12
SP25/PG21/A	7TCA296020R0208	3/10
SP25/PG21/B	7TCA296020R0210	3/10

Part No.	GID No.	Page
SP25/PG21/M	7TCA296020R0215	3/12
SP32/100/M	7TCA296020R0218	3/12
SP32/32/C	7TCA296020R0220	3/13
SP32/BL/25M	7TCA296020R0227	3/9
SP32/E	7TCA296020R0239	3/13
SP32/M32/A	7TCA296020R0243	3/10
SP32/M32/B	7TCA296020R0247	3/11
SP32/M32/C90	7TCA296020R0251	3/11
SP32/M32/F	7TCA296020R0252	3/12
SP32/M32/M	7TCA296020R0253	3/12
SP32/PG29/A	7TCA296020R0256	3/10
SP32/PG29/B	7TCA296020R0258	3/10
SP32/PG29/M	7TCA296020R0262	3/12
SP40/40/C	7TCA296020R0264	3/13
SP40/BL/25M	7TCA296020R0267	3/9
SP40/E	7TCA296020R0269	3/13
SP40/M40/A	7TCA296020R0272	3/10
SP40/M40/B	7TCA296020R0274	3/11
SP40/M40/M	7TCA296020R0276	3/12
SP40/PG36/A	7TCA296020R0280	3/10
SP40/PG36/B	7TCA296020R0282	3/11
SP50/51/C	7TCA296020R0286	3/13
SP50/BL/25M	7TCA296020R0290	3/9
SP50/E	7TCA296020R0296	3/13
SP50/M50/A	7TCA296020R0298	3/10
SP50/M50/B	7TCA296020R0299	3/11
SP50/M50/M	7TCA296020R0302	3/12
SP50/PG42/A	7TCA296020R0304	3/10
SP50/PG42/B	7TCA296020R0305	3/11
SP63/BL/10M	7TCA296020R0310	3/9
SP63/M63/A	7TCA296020R0316	3/10
SP75/75/C	7TCA296020R0334	3/13
SP75/BL/25M	7TCA296020R0337	3/9
SPB10/25M	7TCA296040R0094	3/24
SPB10/M12/A	7TCA296040R0096	3/25
SPB10/M12/B	7TCA296040R0097	3/25
SPB12/10M	7TCA296040R0100	3/24
SPB12/M16/A	7TCA296040R0106	3/25
SPB12/M16/B	7TCA296040R0107	3/25
SPB16/25M	7TCA296040R0112	3/24
SPB16/M16/A	7TCA296040R0115	3/25
SPB16/M16/B	7TCA296040R0116	3/25
SPB20/25M	7TCA296040R0122	3/24
SPB20/M20/A	7TCA296040R0126	3/25
SPB20/M20/B	7TCA296040R0127	3/25
SPB25/25M	7TCA296040R0135	3/24
SPB25/M25/A	7TCA296040R0140	3/25
SPB25/M25/B	7TCA296040R0141	3/25
SPB32/25M	7TCA296040R0149	3/24
SPB32/M32/A	7TCA296040R0153	3/25
SPB32/M32/B	7TCA296040R0154	3/25
SPB40/10M	7TCA296040R0156	3/23
SPB40/M40/A	7TCA296040R0157	3/24
SPB40/M40/B	7TCA296040R0158	3/24

Index

Order code classification

Part No.	GID No.	Page	Part No.	GID No.	Page	Part No.	GID No.	Page
SPL10/M12/M	7TCA296030R0046	3/19	SPL40/PG36/M	7TCA296030R0287	3/19	SPLHCB20/25M	7TCA296100R0170	3/26
SPL10/PG7/M	7TCA296030R0052	3/19	SPL50/10M	7TCA296030R0289	3/14	SPLHCB20/25M	7TCA296100R0170	3/26
SPL12/50M	7TCA296030R0057	3/14	SPL50/150/M	7TCA296030R0290	3/19	SPLHCB32/25M	7TCA296100R0173	3/26
SPL12/E	7TCA296030R0059	3/18	SPL50/E	7TCA296030R0297	3/18	SPLHCB40/10M	7TCA296100R0174	3/26
SPL12/M16/M	7TCA296030R0065	3/19	SPL50/M50/C45	7TCA296030R0386	3/20	SPLHCB50/10M	7TCA296100R0176	3/26
SPL12/PG9/M	7TCA296030R0068	3/19	SPL50/M50/C90	7TCA296030R0392	3/20	SPTC10/25M	7TCA296100R0180	3/24
SPL16/038/M	7TCA296030R0072	3/19	SPL50/M50/M	7TCA296030R0305	3/19	SPTC12/25M	7TCA296040R0166	3/24
SPL16/50M	7TCA296030R0080	3/14	SPL50/PG42/M	7TCA296030R0308	3/19	SPTC16/25M	7TCA296100R0182	3/24
SPL16/E	7TCA296030R0082	3/18	SPL63/25M	7TCA296030R0313	3/14	SPTC20/25M	7TCA296100R0184	3/24
SPL16/M16/A	7TCA296030R0091	3/17	SPL63/E	7TCA296030R0316	3/18	SPTC25/25M	7TCA296100R0185	3/24
SPL16/M16/B	7TCA296030R0092	3/18	SPL63/M63/C45	7TCA296030R0387	3/20	SPTC32/10M	7TCA296100R0186	3/24
SPL16/M16/C45	7TCA296030R0398	3/20	SPL63/M63/C90	7TCA296030R0393	3/20	SPTC40/10M	7TCA296100R0187	3/24
SPL16/M16/C90	7TCA296030R0093	3/20	SPL63/M63/M	7TCA296030R0322	3/19	SPTC50/10M	7TCA296100R0188	3/24
SPL16/M16/M	7TCA296030R0096	3/19	SPL63/PG48/M	7TCA296030R0325	3/19	SPUL16/25M	7TCA296030R0365	3/17
SPL16/M20/A	7TCA296030R0103	3/17	SPL-EF12/10M	7TCA296030R0467	3/15	SPUL16/50M	7TCA296030R0366	3/17
SPL16/M20/B	7TCA296030R0104	3/18	SPL-EF12/25M	7TCA296030R0468	3/15	SPUL20/50M	7TCA296030R0367	3/17
SPL16/M20/C45	7TCA296030R0397	3/20	SPL-EF16/10M	7TCA296030R0469	3/15	SPUL25/25M	7TCA296030R0368	3/17
SPL16/M20/C90	7TCA296030R0105	3/20	SPL-EF16/25M	7TCA296030R0470	3/15	SPUL25/50M	7TCA296030R0369	3/17
SPL16/M20/M	7TCA296030R0107	3/19	SPL-EF16/50M	7TCA296030R0471	3/15	SPUL32/25M	7TCA296030R0370	3/17
SPL16/PG11/M	7TCA296030R0115	3/19	SPL-EF20/10M	7TCA296030R0472	3/15	SPUL40/25M	7TCA296030R0371	3/17
SPL16/PG13/M	7TCA296030R0122	3/19	SPL-EF20/25M	7TCA296030R0473	3/15	SPUL50/25M	7TCA296030R0375	3/17
SPL20/050/M	7TCA296030R0130	3/19	SPL-EF20/50M	7TCA296030R0474	3/15	SPUL63/10M	7TCA296030R0376	3/17
SPL20/25M	7TCA296030R0140	3/14	SPL-EF25/10M	7TCA296030R0475	3/15	SPUL63/25M	7TCA296030R0377	3/17
SPL20/E	7TCA296030R0147	3/18	SPL-EF25/25M	7TCA296030R0476	3/15	SS10/25M	7TCA296120R0005	3/6
SPL20/M20/A	7TCA296030R0157	3/17	SPL-EF25/50M	7TCA296030R0477	3/15	SS12/25M	7TCA296120R0008	3/6
SPL20/M20/B	7TCA296030R0158	3/18	SPL-EF32/10M	7TCA296030R0481	3/15	SS16/25M	7TCA296120R0014	3/6
SPL20/M20/C45	7TCA296030R0399	3/20	SPL-EF32/25M	7TCA296030R0478	3/15	SS20/25M	7TCA296120R0020	3/6
SPL20/M20/C90	7TCA296030R0160	3/20	SPL-EF32/50M	7TCA296030R0479	3/15	SS25/25M	7TCA296120R0026	3/6
SPL20/M20/M	7TCA296030R0163	3/19	SPL-EF40/10M	7TCA296030R0482	3/15	SS32/25M	7TCA296120R0032	3/6
SPL20/PG16/M	7TCA296030R0174	3/19	SPL-EF40/25M	7TCA296030R0484	3/15	SSB12/25M	7TCA296100R0190	3/22
SPL25	7TCA296030R0179	3/14	SPL-EF50/10M	7TCA296030R0483	3/15	SSB16/25M	7TCA296100R0191	3/22
SPL25/075/M	7TCA296030R0184	3/19	SPL-EF50/25M	7TCA296030R0480	3/15	SSB20/25M	7TCA296100R0192	3/22
SPL25/E	7TCA296030R0198	3/18	SPLB16/M16/A	7TCA296100R0149	3/26	SSB25/25M	7TCA296100R0193	3/22
SPL25/M25/A	7TCA296030R0210	3/17	SPLB16/M16/B	7TCA296100R0150	3/27	SSB32/10M	7TCA296100R0194	3/22
SPL25/M25/B	7TCA296030R0211	3/18	SPLB16/M20/A	7TCA296100R0151	3/26	SSBGS12/25M	7TCA296100R0195	3/22
SPL25/M25/C45	7TCA296030R0400	3/20	SPLB16/M20/B	7TCA296100R0152	3/27	SSBGS16/25M	7TCA296100R0196	3/22
SPL25/M25/C90	7TCA296030R0212	3/20	SPLB20/M20/A	7TCA296100R0156	3/26	SSBGS20/25M	7TCA296100R0197	3/22
SPL25/M25/M	7TCA296030R0215	3/19	SPLB20/M20/B	7TCA296100R0157	3/27	SSBGS25/25M	7TCA296100R0198	3/22
SPL25/PG21/M	7TCA296030R0228	3/19	SPLB25/M25/A	7TCA296100R0158	3/26	SSBGS32/25M	7TCA296100R0199	3/22
SPL32/100/M	7TCA296030R0234	3/19	SPLB25/M25/B	7TCA296100R0159	3/27	STC10/25M	7TCA296010R0192	3/21
SPL32/25M	7TCA296030R0238	3/14	SPLB32/M32/A	7TCA296100R0161	3/26	STC12/25M	7TCA296100R0202	3/21
SPL32/E	7TCA296030R0243	3/18	SPLB32/M32/B	7TCA296100R0162	3/27	STC16/25M	7TCA296100R0204	3/21
SPL32/M32/A	7TCA296030R0252	3/17	SPLB40/M40/A	7TCA296100R0164	3/26	STC20/25M	7TCA296100R0205	3/21
SPL32/M32/B	7TCA296030R0253	3/18	SPLB50/M50/A	7TCA296100R0166	3/26	STC25/25M	7TCA296100R0206	3/21
SPL32/M32/C45	7TCA296030R0384	3/20	SPLHC10/25M	7TCA296030R0330	3/16	STC32/10M	7TCA296100R0207	3/21
SPL32/M32/C90	7TCA296030R0254	3/20	SPLHC12/25M	7TCA296030R0332	3/16	STC40/10M	7TCA296100R0209	3/21
SPL32/M32/M	7TCA296030R0256	3/19	SPLHC16/50M	7TCA296030R0336	3/16	STC50/10M	7TCA296100R0211	3/21
SPL32/PG29/M	7TCA296030R0264	3/19	SPLHC20/25M	7TCA296030R0340	3/16	SWINGCUT	7TCA296050R0485	5/2
SPL40/10M	7TCA296030R0267	3/14	SPLHC25/25M	7TCA296030R0345	3/16	SWM12	7TCA296050R0487	2/52
SPL40/125/M	7TCA296030R0268	3/19	SPLHC32/25M	7TCA296030R0348	3/16	SWM16	7TCA296050R0488	2/52
SPL40/E	7TCA296030R0274	3/18	SPLHC40/10M	7TCA296030R0351	3/16	SWM20	7TCA296050R0492	2/52
SPL40/M40/C45	7TCA296030R0385	3/20	SPLHC50/25M	7TCA296030R0357	3/16	SWM25	7TCA296050R0497	2/52
SPL40/M40/C90	7TCA296030R0391	3/20	SPLHC63/25M	7TCA296030R0360	3/16	SWM32	7TCA296050R0502	2/52
SPL40/M40/M	7TCA296030R0283	3/19	SPLHCB16/25M	7TCA296100R0169	3/26	SWM40	7TCA296050R0506	2/52

Part No.	GID No.	Page
SWM50	7TCA296050R0510	2/52
SWM63	7TCA296050R0514	2/52
T101010/BL	7TCA296000R2526	2/55
T101310/BL	7TCA296000R2527	2/55
T101613/BL	7TCA296000R2528	2/55
T131010/BL	7TCA296000R2531	2/55
T131013/BL	7TCA296000R2532	2/55
T131310/BL	7TCA296000R2535	2/55
T131313/BL	7TCA296000R2537	2/55
T131613/BL	7TCA296000R2539	2/55
T161013/BL	7TCA296050R0529	2/55
T161016/BL	7TCA296000R2541	2/55
T161116/BL	7TCA296000R2543	2/55
T161313/BL	7TCA296000R2544	2/55
T161316/BL	7TCA296050R0530	2/55
T161613/BL	7TCA296000R2546	2/55
T161616/BL	7TCA296000R2547	2/55
T162116/BL	7TCA296000R2550	2/55
T211016/BL	7TCA296160R0102	2/55
T211021/BL	7TCA296000R2551	2/55
T211316/BL	7TCA296000R2554	2/55
T211321/BL	7TCA296000R2555	2/55
T211613/BL	7TCA296000R2557	2/55
T211616/BL	7TCA296000R2558	2/55
T211621/BL	7TCA296000R2559	2/55
T212113/BL	7TCA296000R2560	2/55
T212116/BL	7TCA296000R2561	2/55
T212121/BL	7TCA296000R2562	2/55
T281021/BL	7TCA296000R2576	2/55
T281028/BL	7TCA296000R2577	2/55
T281321/BL	7TCA296000R2578	2/55
T281621/BL	7TCA296000R2581	2/55
T281628/BL	7TCA296000R2582	2/55
T282121/BL	7TCA296000R2583	2/55
T282128/BL	7TCA296000R2584	2/55
T282828/BL	7TCA296000R2587	2/55
T341634/BL	7TCA296000R2589	2/55
T342128/BL	7TCA296000R2591	2/55
T342134/BL	7TCA296000R2592	2/55
T343434/BL	7TCA296000R2596	2/55
XF12/30M	7TCA296060R0095	2/49
XF12/M16/D	7TCA296060R0097	2/50
XF16/30M	7TCA296060R0101	2/49
XF16/M16/C90/BL	7TCA296060R0104	2/50
XF16/M16/D	7TCA296060R0105	2/50
XF16/M20/D	7TCA296060R0107	2/50
XF20/30M	7TCA296060R0112	2/49
XF20/M20/C90/BL	7TCA296060R0115	2/50
XF20/M20/D	7TCA296060R0116	2/50
XF25/30M	7TCA296060R0121	2/49
XF25/M25/C90/BL	7TCA296060R0124	2/50
XF25/M25/D	7TCA296060R0125	2/50
XF32/30M	7TCA296060R0131	2/49
XF32/M32/C90/BL	7TCA296060R0134	2/50

Part No.	GID No.	Page
XF32/M32/D	7TCA296060R0135	2/50
XF40/30M	7TCA296060R0140	2/49
XF40/M40/D	7TCA296060R0144	2/50
XF50/30M	7TCA296060R0148	2/49
XF50/M50/D	7TCA296060R0151	2/50
Y101010/BL	7TCA296000R2603	2/56
Y101013/BL	7TCA296000R2605	2/56
Y131010/BL	7TCA296000R2608	2/56
Y131310/BL	7TCA296000R2612	2/56
Y131313/BL	7TCA296000R2614	2/56
Y161310/BL	7TCA296000R2618	2/56
Y161313/BL	7TCA296000R2621	2/56
Y161610/BL	7TCA296000R2623	2/56
Y161613/BL	7TCA296000R2625	2/56
Y211010/BL	7TCA296000R2626	2/56
Y211310/BL	7TCA296000R2627	2/56
Y211313/BL	7TCA296000R2628	2/56
Y211610/BL	7TCA296000R2629	2/56
Y211613/BL	7TCA296000R2630	2/56
Y211616/BL	7TCA296000R2631	2/56
Y212110/BL	7TCA296000R2633	2/56
Y212113/BL	7TCA296000R2635	2/56
Y212116/BL	7TCA296000R2636	2/56
Y282113/BL	7TCA296000R2645	2/56
Y282116/BL	7TCA296000R2646	2/56
Y282121/BL	7TCA296000R2647	2/56
Y282810/BL	7TCA296000R2650	2/56
Y282813/BL	7TCA296000R2651	2/56
Y282816/BL	7TCA296050R0537	2/56
Y282821/BL	7TCA296000R2652	2/56
Y282828/BL	7TCA296000R2653	2/56
Y343416/BL	7TCA296000R2658	2/56
Y343421/BL	7TCA296000R2659	2/56
Y343434/BL	7TCA296000R2661	2/56

Contact us

Adaptaflex

UK Head Office

Station Road

Coleshill

Birmingham B46 1HT

Tel: +44 (0) 1675 468 222

Fax: +44 (0) 1675 464 930

UK Sales Tel: +44 (0) 1675 468 200

E-Mail: sales@adaptaflex.com

www.adaptaflex.com

Note: We reserve the right to make technical changes or modify the contents of this document without prior notice. With regard to purchase orders, the agreed particulars shall prevail. Adaptaflex does not accept any responsibility whatsoever for potential errors or possible lack of information in this document.

We reserve all rights in this document and in the subject matter and illustrations contained therein. Any reproduction, disclosure to third parties or utilization of its contents – in whole or in parts – is forbidden without prior written consent of Adaptaflex.

Copyright © 2016 Adaptaflex

All rights reserved