

Aluminum Electrolytic, 85C, ELH, 150 uF, 20%, 400 V, -25/+85C

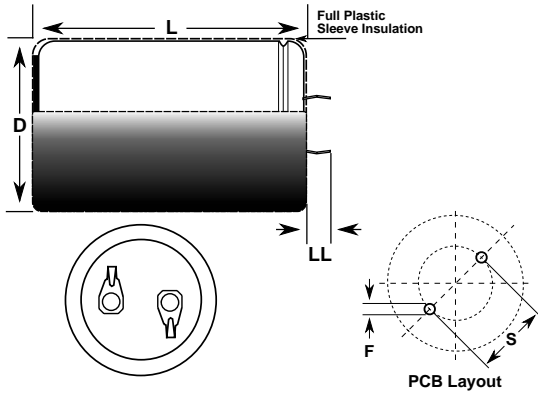

Dimensions	
D	25mm +/-1mm
L	30mm +/-2mm
S	10mm +/-0.5mm
LL	5.8mm +/-1mm
F	2mm +/-0.1mm

Packaging Specifications	
Packaging:	Bulk
Packaging Quantity:	200

General Information	
Dielectric:	Aluminum Electrolytic
Series:	ELH
Description:	Snap-In, Aluminum Electrolytic
RoHS:	Yes
Lead:	2 Pin

Specifications	
Capacitance:	150 uF
Capacitance Tolerance:	20%
Voltage DC:	400 VDC, 450 VDC (Surge)
Temperature Range:	-25/+85C
Rated Temperature:	85C
Life:	2000 Hrs
Dissipation Factor:	15%
Resistance:	388 mOhms (20kHz 25C)
Current:	1150 mAmps (120Hz)
Leakage:	1200 uAmps (5min 20C)