

Aluminum Electrolytic, 85C, ESK, 10 uF, 20%, 350 V, -25/+85C, 15mm, Lead Spacing = 5mm

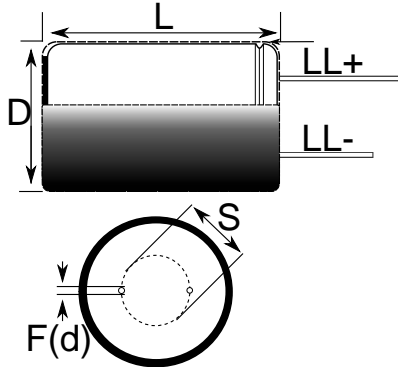

Note: '()' correspond to the letters used in the product bulletin

Dimensions	
D	10mm +/-0.5mm
L	15mm +2mm
S	5mm +/-0.5mm
LL Negative	15mm MIN
LL Positive	20mm MIN
F	0.6mm NOM

Packaging Specifications	
Packaging:	Bulk, Bag
Packaging Quantity:	3000

General Information	
Dielectric:	Aluminum Electrolytic
Series:	ESK
Description:	Single Ended, Aluminum Electrolytic
RoHS:	Yes
Lead:	Wire Leads

Specifications	
Capacitance:	10 uF
Capacitance Tolerance:	20%
Voltage DC:	350 VDC, 400 VDC (Surge)
Temperature Range:	-25/+85C
Rated Temperature:	85C
Life:	2000 Hrs
Dissipation Factor:	24% 120Hz 20C
Current:	70 mAmps (120Hz 85C)
Leakage:	115 uAmps (2min 20C)
Impedance Ratio at -25C:	10