

Aluminum Electrolytic, 105C LowZ, EXV, 47 uF, 20%, 35 V, -55/+105C

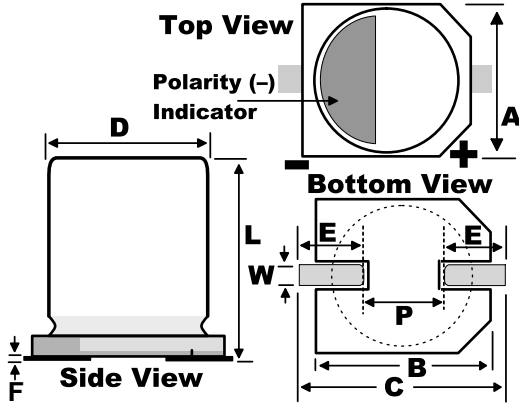

Dimensions	
D	6.3mm +/-0.5mm
L	7.7mm +/-0.3mm
W	0.65mm +/-0.1mm
F	0.3mm MAX
A	6.6mm +/-0.2mm
B	6.6mm +/-0.2mm
C	7.8mm MAX
E	2.6mm +/-0.2mm
P	1.8mm +/-0.2mm

Packaging Specifications	
Packaging:	T&R, 380mm
Packaging Quantity:	1000

General Information	
Dielectric:	Aluminum Electrolytic
Style:	SMD Can
Series:	EXV
Description:	Surface Mount, Aluminum Electrolytic
Features:	Ultra Low Impedance
RoHS:	Yes
Lead:	V-Chip

Specifications	
Capacitance:	47 uF
Capacitance Tolerance:	20%
Voltage DC:	35 VDC, 44 VDC (Surge)
Temperature Range:	-55/+105C
Rated Temperature:	105C
Life:	3000 Hrs
Dissipation Factor:	12%
Resistance:	0.34 Ohms (100kHz)
Current:	196 mAmps (120Hz), 392 mAmps (120Hz 85C), 280 mAmps (100kHz)
Leakage:	16.5 uAmps (2min 20C)
Impedance Ratio at -25C:	2
Impedance Ratio at -40C:	3
High Temperature Solder:	Yes