

Aluminum Electrolytic, 105C LowZ, EXV, 470 uF, 20%, 10 V, -55/+105C

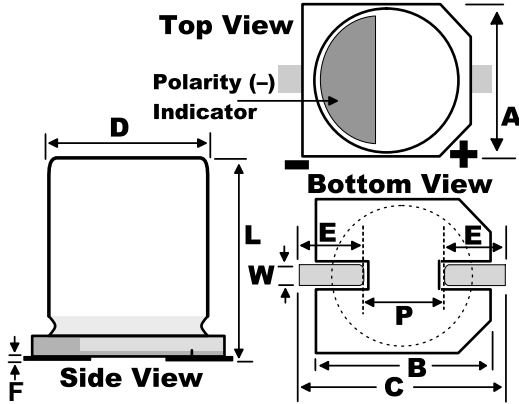

Dimensions	
D	10mm +/-0.5mm
L	10.2mm +/-0.3mm
W	0.9mm +/-0.2mm
F	0.3mm MAX
A	10.3mm +/-0.2mm
B	10.3mm +/-0.2mm
C	12mm MAX
E	3.5mm +/-0.2mm
P	4.6mm +/-0.2mm

Packaging Specifications	
Packaging:	T&R, 380mm
Packaging Quantity:	500

General Information	
Dielectric:	Aluminum Electrolytic
Style:	SMD Can
Series:	EXV
Description:	Surface Mount, Aluminum Electrolytic
Features:	Ultra Low Impedance
RoHS:	Yes
Lead:	V-Chip

Specifications	
Capacitance:	470 uF
Capacitance Tolerance:	20%
Voltage DC:	10 VDC, 13 VDC (Surge)
Temperature Range:	-55/+105C
Rated Temperature:	105C
Life:	5000 Hrs
Dissipation Factor:	19%
Resistance:	0.12 Ohms (100kHz)
Current:	595 mAmps (120Hz), 1190 mAmps (120Hz 85C), 850 mAmps (100kHz)
Leakage:	47 uAmps (2min 20C)
Impedance Ratio at -25C:	2
Impedance Ratio at -40C:	3
High Temperature Solder:	Yes