

Polymer Aluminum, 105C LowZ, A765, 330 uF, 20%, 10 V, -55/+105C

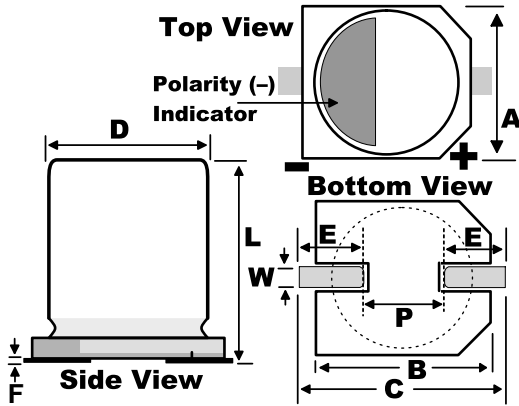

Dimensions	
D	8mm +/-0.5mm
L	7.5mm +/-0.3mm
W	0.8mm +0.3mm
A	8.3mm +/-0.2mm
B	8.3mm +/-0.2mm
C	9mm +/-0.2mm
E	2.9mm NOM
P	3.2mm NOM

Packaging Specifications	
Packaging:	T&R, 380mm
Packaging Quantity:	500

General Information	
Dielectric:	Polymer Aluminum
Style:	SMD Can
Series:	A765
Description:	Surface Mount, Polymer Aluminum
RoHS:	Yes
Lead:	V-Chip

Specifications	
Capacitance:	330 uF
Capacitance Tolerance:	20%
Voltage DC:	10 VDC, 11.5 VDC (Surge)
Temperature Range:	-55/+105C
Rated Temperature:	105C
Life:	2000 Hrs
Resistance:	17 mOhms (100kHz 20C)
Current:	2350 mAmps (100kHz 105C)
Impedance Ratio at -25C:	1.25
Impedance Ratio at -55C:	1.25