

Ceramic, Safety, ERP610, 470 pF, 20%, Y5U, Lead Spacing = 12.5mm

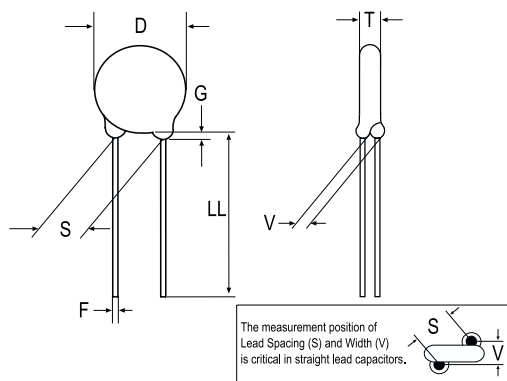

Dimensions

D	8mm MAX
T	5mm MAX
S	12.5mm NOM
LL	30mm -3mm
F	0.6mm +/-0.05mm
G	3mm MAX

Packaging Specifications

Packaging:	Bulk, Bag
-------------------	-----------

General Information

Style:	Radial Disc
Series:	ERP610
Description:	Ceramic Single Layer Safety Disc Capacitors
RoHS:	Yes
Termination:	Tin
Approvals:	UL, CSA, ENEC

Specifications

Capacitance:	470 pF
Capacitance Tolerance:	20%
Temperature Range:	-40/+125C
Temperature Coefficient:	Y5U
Dissipation Factor:	2.5%
Insulation Resistance:	10 GOhms
Voltage:	760 VAC (X1), 500 VAC (Y1)