



Is Now Part of



ON Semiconductor®

To learn more about ON Semiconductor, please visit our website at
www.onsemi.com

ON Semiconductor and the ON Semiconductor logo are trademarks of Semiconductor Components Industries, LLC dba ON Semiconductor or its subsidiaries in the United States and/or other countries. ON Semiconductor owns the rights to a number of patents, trademarks, copyrights, trade secrets, and other intellectual property. A listing of ON Semiconductor's product/patent coverage may be accessed at www.onsemi.com/site/pdf/Patent-Marking.pdf. ON Semiconductor reserves the right to make changes without further notice to any products herein. ON Semiconductor makes no warranty, representation or guarantee regarding the suitability of its products for any particular purpose, nor does ON Semiconductor assume any liability arising out of the application or use of any product or circuit, and specifically disclaims any and all liability, including without limitation special, consequential or incidental damages. Buyer is responsible for its products and applications using ON Semiconductor products, including compliance with all laws, regulations and safety requirements or standards, regardless of any support or applications information provided by ON Semiconductor. "Typical" parameters which may be provided in ON Semiconductor data sheets and/or specifications can and do vary in different applications and actual performance may vary over time. All operating parameters, including "Typicals" must be validated for each customer application by customer's technical experts. ON Semiconductor does not convey any license under its patent rights nor the rights of others. ON Semiconductor products are not designed, intended, or authorized for use as a critical component in life support systems or any FDA Class 3 medical devices or medical devices with a same or similar classification in a foreign jurisdiction or any devices intended for implantation in the human body. Should Buyer purchase or use ON Semiconductor products for any such unintended or unauthorized application, Buyer shall indemnify and hold ON Semiconductor and its officers, employees, subsidiaries, affiliates, and distributors harmless against all claims, costs, damages, and expenses, and reasonable attorney fees arising out of, directly or indirectly, any claim of personal injury or death associated with such unintended or unauthorized use, even if such claim alleges that ON Semiconductor was negligent regarding the design or manufacture of the part. ON Semiconductor is an Equal Opportunity/Affirmative Action Employer. This literature is subject to all applicable copyright laws and is not for resale in any manner.

FDC6331L

Integrated Load Switch

General Description

This device is particularly suited for compact power management in portable electronic equipment where 2.5V to 8V input and 2.8A output current capability are needed. This load switch integrates a small N-Channel power MOSFET (Q1) that drives a large P-Channel power MOSFET (Q2) in one tiny SuperSOT™-6 package.

Applications

- Load switch
- Power management



Features

- -2.8 A, -8 V. $R_{DS(ON)} = 55\text{ m}\Omega @ V_{GS} = -4.5\text{ V}$
 $R_{DS(ON)} = 70\text{ m}\Omega @ V_{GS} = -2.5\text{ V}$
 $R_{DS(ON)} = 100\text{ m}\Omega @ V_{GS} = -1.8\text{ V}$
- Control MOSFET (Q1) includes Zener protection for ESD ruggedness (>6KV Human body model)
- High performance trench technology for extremely low $R_{DS(ON)}$

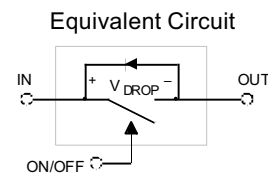
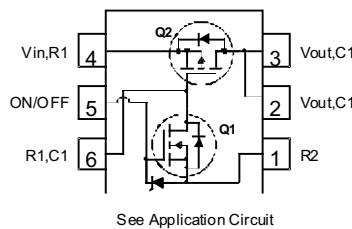
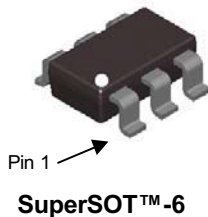

Absolute Maximum Ratings T_A=25°C unless otherwise noted

Symbol	Parameter	Ratings	Units
V _{IN}	Maximum Input Voltage	± 8	V
V _{ON/OFF}	High level ON/OFF voltage range	-0.5 to 8	V
I _{Load}	Load Current – Continuous (Note 1)	2.8	A
	– Pulsed	9	
P _D	Maximum Power Dissipation (Note 1)	0.7	W
T _J , T _{STG}	Operating and Storage Junction Temperature Range	-55 to +150	°C

Thermal Characteristics

R _{θJA}	Thermal Resistance, Junction-to-Ambient (Note 1)	180	°C/W
R _{θJC}	Thermal Resistance, Junction-to-Case (Note 1)	60	°C/W

Package Marking and Ordering Information

Device Marking	Device	Reel Size	Tape width	Quantity
.331	FDC6331L	7"	8mm	3000 units

Electrical Characteristics

$T_A = 25^\circ\text{C}$ unless otherwise noted

Symbol	Parameter	Test Conditions	Min	Typ	Max	Units
Off Characteristics						
BV_{IN}	Vin Breakdown Voltage	$V_{ON/OFF} = 0\text{ V}$, $I_D = -250\ \mu\text{A}$	8			V
I_{Load}	Zero Gate Voltage Drain Current	$V_{IN} = 6.4\text{ V}$, $V_{ON/OFF} = 0\text{ V}$			-1	μA
I_{FL}	Leakage Current, Forward	$V_{ON/OFF} = 0\text{ V}$, $V_{IN} = 8\text{ V}$			-100	nA
I_{RL}	Leakage Current, Reverse	$V_{ON/OFF} = 0\text{ V}$, $V_{IN} = -8\text{ V}$			100	nA
On Characteristics (Note 2)						
$V_{ON/OFF(th)}$	Gate Threshold Voltage	$V_{IN} = V_{ON/OFF}$, $I_D = -250\ \mu\text{A}$	0.4	0.9	1.5	V
$R_{DS(on)}$	Static Drain-Source On-Resistance (Q2)	$V_{GS} = -4.5\text{ V}$, $I_D = -2.8\text{ A}$ $V_{GS} = -2.5\text{ V}$, $I_D = -2.5\text{ A}$ $V_{GS} = -1.8\text{ V}$, $I_D = -2.0\text{ A}$		34 45 64	55 70 100	m Ω
$R_{DS(on)}$	Static Drain-Source On-Resistance (Q1)	$V_{GS} = 4.5\text{ V}$, $I_D = 0.4\text{ A}$ $V_{GS} = 2.7\text{ V}$, $I_D = 0.2\text{ A}$		3.1 3.8	4 5	Ω
Drain-Source Diode Characteristics and Maximum Ratings						
I_S	Maximum Continuous Drain-Source Diode Forward Current				-0.6	A
V_{SD}	Drain-Source Diode Forward Voltage	$V_{ON/OFF} = 0\text{ V}$, $I_S = -0.6\text{ A}$ (Note 2)			-1.2	V

Notes:

- $R_{\theta JA}$ is the sum of the junction-to-case and case-to-ambient thermal resistance where the case thermal reference is defined as the solder mounting surface of the drain pins. $R_{\theta JC}$ is guaranteed by design while $R_{\theta JA}$ is determined by the user's board design.
- Pulse Test: Pulse Width < 300 μs , Duty Cycle < 2.0%.

FDC6331L Load Switch Application Circuit

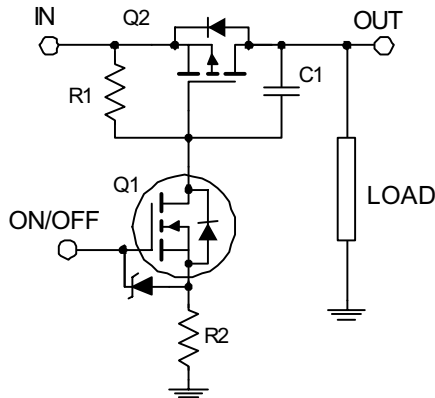

External Component Recommendation:

For additional in-rush current control, R2 and C1 can be added. For more information, see application note AN1030.

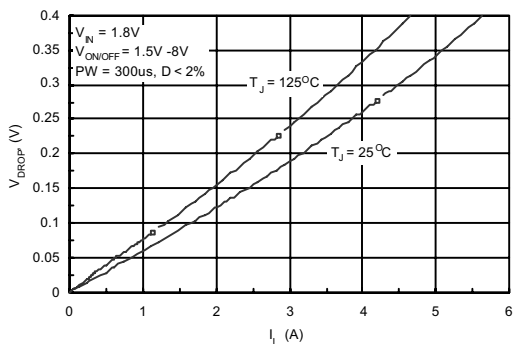

Figure 1. Conduction Voltage Drop Variation with Load Current.

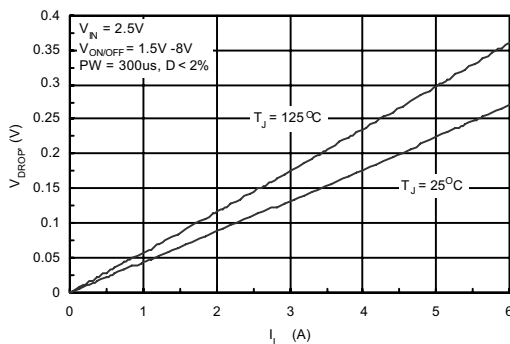

Figure 2. Conduction Voltage Drop Variation with Load Current.

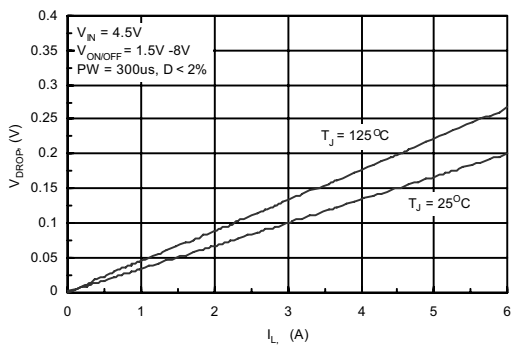

Figure 3. Conduction Voltage Drop Variation with Load Current.

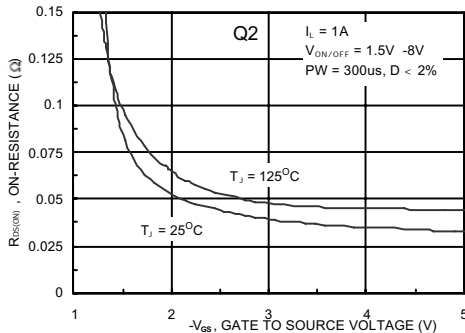

Figure 4. On-Resistance Variation With Input Voltage

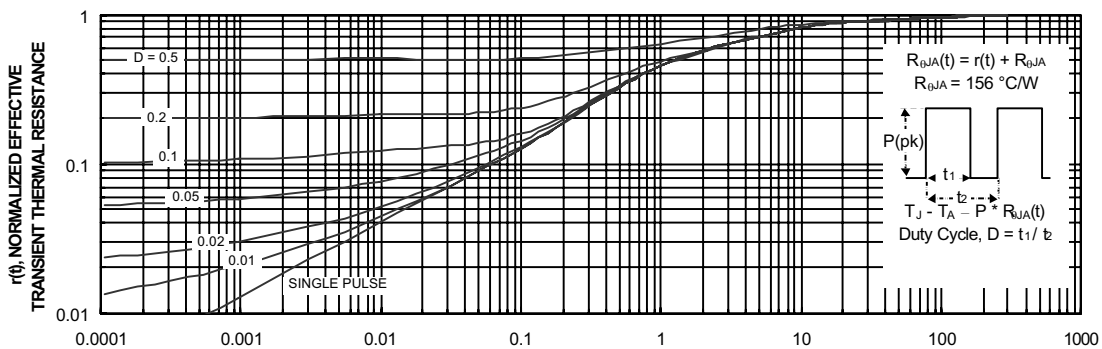



Figure 5. Transient Thermal Response Curve.

Thermal characterization performed on the conditions described in Note 2.
 Transient thermal response will change depends on the circuit board design.



TRADEMARKS

The following are registered and unregistered trademarks Fairchild Semiconductor owns or is authorized to use and is not intended to be an exhaustive list of all such trademarks.

ACEx®	HiSeC™	Programmable Active Droop™	TinyLogic®
Across the board. Around the world™	<i>i-Lo</i> ™	QFET®	TINYOPTO™
ActiveArray™	ImpliedDisconnect™	QS™	TinyPower™
Bottomless™	IntelliMAX™	QT Optoelectronics™	TinyWire™
Build it Now™	ISOPLANAR™	Quiet Series™	TruTranslation™
CoolFET™	MICROCOUPLER™	RapidConfigure™	µSerDes™
CROSSVOLT™	MicroPak™	RapidConnect™	UHC®
CTL™	MICROWIRE™	ScalarPump™	UniFET™
Current Transfer Logic™	MSX™	SMART START™	VCX™
DOME™	MSXPro™	SPM®	Wire™
E ² CMOS™	OCX™	STEALTH™	
EcoSPARK®	OCXPro™	SuperFET™	
EnSigna™	OPTOLOGIC®	SuperSOT™-3	
FACT Quiet Series™	OPTOPLANAR®	SuperSOT™-6	
FACT®	PACMAN™	SuperSOT™-8	
FAST®	POP™	SyncFET™	
FASTr™	Power220®	TCM™	
FPS™	Power247®	The Power Franchise®	
FRFET®	PowerEdge™	 ™	
GlobalOptoisolator™	PowerSaver™	TinyBoost™	
GTO™	PowerTrench®	TinyBuck™	

DISCLAIMER

FAIRCHILD SEMICONDUCTOR RESERVES THE RIGHT TO MAKE CHANGES WITHOUT FURTHER NOTICE TO ANY PRODUCTS HEREIN TO IMPROVE RELIABILITY, FUNCTION OR DESIGN. FAIRCHILD DOES NOT ASSUME ANY LIABILITY ARISING OUT OF THE APPLICATION OR USE OF ANY PRODUCT OR CIRCUIT DESCRIBED HEREIN; NEITHER DOES IT CONVEY ANY LICENSE UNDER ITS PATENT RIGHTS, NOR THE RIGHTS OF OTHERS. THESE SPECIFICATIONS DO NOT EXPAND THE TERMS OF FAIRCHILD'S WORLDWIDE TERMS AND CONDITIONS, SPECIFICALLY THE WARRANTY THEREIN, WHICH COVERS THESE PRODUCTS.

LIFE SUPPORT POLICY

FAIRCHILD'S PRODUCTS ARE NOT AUTHORIZED FOR USE AS CRITICAL COMPONENTS IN LIFE SUPPORT DEVICES OR SYSTEMS WITHOUT THE EXPRESS WRITTEN APPROVAL OF FAIRCHILD SEMICONDUCTOR CORPORATION.

As used herein:

1. Life support devices or systems are devices or systems which, (a) are intended for surgical implant into the body or (b) support or sustain life, and (c) whose failure to perform when properly used in accordance with instructions for use provided in the labeling, can be reasonably expected to result in a significant injury of the user.
2. A critical component in any component of a life support, device, or system whose failure to perform can be reasonably expected to cause the failure of the life support device or system, or to affect its safety or effectiveness.

PRODUCT STATUS DEFINITIONS

Definition of Terms

Datasheet Identification	Product Status	Definition
Advance Information	Formative or In Design	This datasheet contains the design specifications for product development. Specifications may change in any manner without notice.
Preliminary	First Production	This datasheet contains preliminary data; supplementary data will be published at a later date. Fairchild Semiconductor reserves the right to make changes at any time without notice to improve design.
No Identification Needed	Full Production	This datasheet contains final specifications. Fairchild Semiconductor reserves the right to make changes at any time without notice to improve design.
Obsolete	Not In Production	This datasheet contains specifications on a product that has been discontinued by Fairchild Semiconductor. The datasheet is printed for reference information only.

ON Semiconductor and  are trademarks of Semiconductor Components Industries, LLC dba ON Semiconductor or its subsidiaries in the United States and/or other countries. ON Semiconductor owns the rights to a number of patents, trademarks, copyrights, trade secrets, and other intellectual property. A listing of ON Semiconductor's product/patent coverage may be accessed at www.onsemi.com/site/pdf/Patent-Marking.pdf. ON Semiconductor reserves the right to make changes without further notice to any products herein. ON Semiconductor makes no warranty, representation or guarantee regarding the suitability of its products for any particular purpose, nor does ON Semiconductor assume any liability arising out of the application or use of any product or circuit, and specifically disclaims any and all liability, including without limitation special, consequential or incidental damages. Buyer is responsible for its products and applications using ON Semiconductor products, including compliance with all laws, regulations and safety requirements or standards, regardless of any support or applications information provided by ON Semiconductor. "Typical" parameters which may be provided in ON Semiconductor data sheets and/or specifications can and do vary in different applications and actual performance may vary over time. All operating parameters, including "Typicals" must be validated for each customer application by customer's technical experts. ON Semiconductor does not convey any license under its patent rights nor the rights of others. ON Semiconductor products are not designed, intended, or authorized for use as a critical component in life support systems or any FDA Class 3 medical devices or medical devices with a same or similar classification in a foreign jurisdiction or any devices intended for implantation in the human body. Should Buyer purchase or use ON Semiconductor products for any such unintended or unauthorized application, Buyer shall indemnify and hold ON Semiconductor and its officers, employees, subsidiaries, affiliates, and distributors harmless against all claims, costs, damages, and expenses, and reasonable attorney fees arising out of, directly or indirectly, any claim of personal injury or death associated with such unintended or unauthorized use, even if such claim alleges that ON Semiconductor was negligent regarding the design or manufacture of the part. ON Semiconductor is an Equal Opportunity/Affirmative Action Employer. This literature is subject to all applicable copyright laws and is not for resale in any manner.

PUBLICATION ORDERING INFORMATION

LITERATURE FULFILLMENT:

Literature Distribution Center for ON Semiconductor
19521 E. 32nd Pkwy, Aurora, Colorado 80011 USA
Phone: 303-675-2175 or 800-344-3860 Toll Free USA/Canada
Fax: 303-675-2176 or 800-344-3867 Toll Free USA/Canada
Email: orderlit@onsemi.com

N. American Technical Support: 800-282-9855 Toll Free
USA/Canada
Europe, Middle East and Africa Technical Support:
Phone: 421 33 790 2910
Japan Customer Focus Center
Phone: 81-3-5817-1050

ON Semiconductor Website: www.onsemi.com
Order Literature: <http://www.onsemi.com/orderlit>
For additional information, please contact your local
Sales Representative