

PLEASE CHECK WWW.MOLEX.COM FOR LATEST PART INFORMATION

Part Number: [0039290043](#)
Status: **Active**
Overview: [Mini-Fit Jr.™ Power Connectors](#)
Description: Mini-Fit Jr.™ Vertical Header, 4.20mm Pitch, Dual Row, 4 Circuits, without Snap-in Plastic Peg PCB Lock, Gold, Natural

Documents:

3D Model	Packaging Specification PK-5566-000 (PDF)
Drawing (PDF)	Packaging Specification PK-5566-003-001 (PDF)
Product Specification PS-5556-001 (PDF)	RoHS Certificate of Compliance (PDF)
Product Specification TS-5556-002-001 (PDF)	

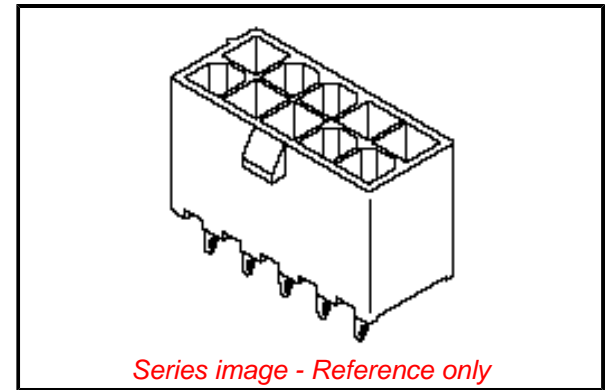

Agency Certification

CSA	LR19980
UL	E29179

General

Product Family	PCB Headers
Series	5566
Application	Power, Wire-to-Board
Comments	The 5566 header should be used with standard Mini-Fit® female terminals. If increased amperage of up to 13A per circuit is needed, please consider using the Mini-Fit® Plus HCS family 45750 terminals with 46015 headers; . See Molex Product specification PS-5666-001 for current de-rating information.
Overview	Mini-Fit Jr.™ Power Connectors
Product Name	Mini-Fit Jr.™
UPC	800754205757

Physical

Breakaway	No
Circuits (Loaded)	4
Circuits (maximum)	4
Color - Resin	Natural
Durability (mating cycles max)	30
First Mate / Last Break	No
Flammability	94V-2
Glow-Wire Compliant	No
Guide to Mating Part	No
Keying to Mating Part	None
Lock to Mating Part	Yes
Material - Metal	Brass
Material - Plating Mating	Gold
Material - Plating Termination	Matte Tin
Material - Resin	Nylon
Net Weight	1207.752/mg
Number of Rows	2
Orientation	Vertical
PC Tail Length	3.50mm
PCB Locator	Yes
PCB Retention	None
PCB Thickness - Recommended	1.60mm
Packaging Type	Bag
Pitch - Mating Interface	4.20mm
Pitch - Termination Interface	4.20mm
Plating min - Mating	0.762µm

EU ELV

Not Relevant

EU RoHS

Compliant

REACH SVHC

Not Contained Per - ED/21/2016 (20 June 2016)

Halogen-Free

Status

Low-Halogen

Need more information on product environmental compliance?

Email productcompliance@molex.com
Please visit the [Contact Us](#) section for any non-product compliance questions.

China ROHS	Green Image
ELV	Not Relevant
RoHS Phthalates	Not Contained

Search Parts in this Series

[5566 Series](#)

Mates With

[5557 Mini-Fit Jr.™ Receptacle Housing](#)

Plating min - Termination	2.540µm
Polarized to Mating Part	Yes
Polarized to PCB	Yes
Shrouded	Fully
Stackable	No
Surface Mount Compatible (SMC)	No
Temperature Range - Operating	-40°C to +105°C
Termination Interface: Style	Through Hole

Electrical

Current - Maximum per Contact	9.0A
Voltage - Maximum	600V

Solder Process Data

Duration at Max. Process Temperature (seconds)	005
Lead-free Process Capability	WAVE
Max. Cycles at Max. Process Temperature	001
Process Temperature max. C	260

Material Info

Engineering Number	5566-04AGS
--------------------	------------

Reference - Drawing Numbers

Packaging Specification	PK-5566-000, PK-5566-003-001
Product Specification	PS-5556-001, TS-5556-002-001
Sales Drawing	SD-5566-002-000

This document was generated on 01/17/2017

PLEASE CHECK WWW.MOLEX.COM FOR LATEST PART INFORMATION