



Is Now Part of



**ON Semiconductor®**

To learn more about ON Semiconductor, please visit our website at  
[www.onsemi.com](http://www.onsemi.com)

ON Semiconductor and the ON Semiconductor logo are trademarks of Semiconductor Components Industries, LLC dba ON Semiconductor or its subsidiaries in the United States and/or other countries. ON Semiconductor owns the rights to a number of patents, trademarks, copyrights, trade secrets, and other intellectual property. A listing of ON Semiconductor's product/patent coverage may be accessed at [www.onsemi.com/site/pdf/Patent-Marking.pdf](http://www.onsemi.com/site/pdf/Patent-Marking.pdf). ON Semiconductor reserves the right to make changes without further notice to any products herein. ON Semiconductor makes no warranty, representation or guarantee regarding the suitability of its products for any particular purpose, nor does ON Semiconductor assume any liability arising out of the application or use of any product or circuit, and specifically disclaims any and all liability, including without limitation special, consequential or incidental damages. Buyer is responsible for its products and applications using ON Semiconductor products, including compliance with all laws, regulations and safety requirements or standards, regardless of any support or applications information provided by ON Semiconductor. "Typical" parameters which may be provided in ON Semiconductor data sheets and/or specifications can and do vary in different applications and actual performance may vary over time. All operating parameters, including "Typicals" must be validated for each customer application by customer's technical experts. ON Semiconductor does not convey any license under its patent rights nor the rights of others. ON Semiconductor products are not designed, intended, or authorized for use as a critical component in life support systems or any FDA Class 3 medical devices or medical devices with a same or similar classification in a foreign jurisdiction or any devices intended for implantation in the human body. Should Buyer purchase or use ON Semiconductor products for any such unintended or unauthorized application, Buyer shall indemnify and hold ON Semiconductor and its officers, employees, subsidiaries, affiliates, and distributors harmless against all claims, costs, damages, and expenses, and reasonable attorney fees arising out of, directly or indirectly, any claim of personal injury or death associated with such unintended or unauthorized use, even if such claim alleges that ON Semiconductor was negligent regarding the design or manufacture of the part. ON Semiconductor is an Equal Opportunity/Affirmative Action Employer. This literature is subject to all applicable copyright laws and is not for resale in any manner.



April 2014

## 2N3906 / MMBT3906 / PZT3906 PNP General-Purpose Amplifier

### Description

This device is designed for general-purpose amplifier and switching applications at collector currents of 10 mA to 100 mA.

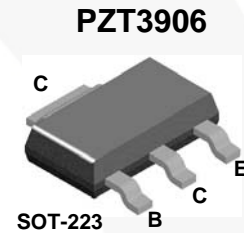
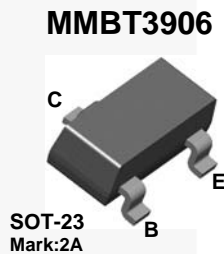
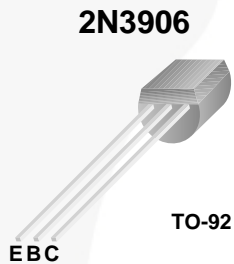

### Ordering Information

Part Number	Marking	Package	Packing Method	Pack Quantity
2N3906BU	2N3906	TO-92 3L	Bulk	10000
2N3906TA	2N3906	TO-92 3L	Ammo	2000
2N3906TAR	2N3906	TO-92 3L	Ammo	2000
2N3906TF	2N3906	TO-92 3L	Tape and Reel	2000
2N3906TFR	2N3906	TO-92 3L	Tape and Reel	2000
MMBT3906	2A	SOT-23 3L	Tape and Reel	3000
PZT3906	3906	SOT-223 4L	Tape and Reel	2500

2N3906 / MMBT3906 / PZT3906 — PNP General-Purpose Amplifier

## Absolute Maximum Ratings<sup>(1)</sup>

Stresses exceeding the absolute maximum ratings may damage the device. The device may not function or be operable above the recommended operating conditions and stressing the parts to these levels is not recommended. In addition, extended exposure to stresses above the recommended operating conditions may affect device reliability. The absolute maximum ratings are stress ratings only. Values are at  $T_A = 25^\circ\text{C}$  unless otherwise noted.

Symbol	Parameter	Value	Unit
$V_{CEO}$	Collector-Emitter Voltage	-40	V
$V_{CBO}$	Collector-Base Voltage	-40	V
$V_{EBO}$	Emitter-Base Voltage	-5.0	V
$I_C$	Collector Current - Continuous	-200	mA
$T_J, T_{STG}$	Operating and Storage Junction Temperature Range	-55 to +150	$^\circ\text{C}$

### Note:

- These ratings are based on a maximum junction temperature of  $150^\circ\text{C}$ .  
These are steady-state limits. Fairchild Semiconductor should be consulted on applications involving pulsed or low-duty cycle operations.

## Thermal Characteristics

Values are at  $T_A = 25^\circ\text{C}$  unless otherwise noted.

Symbol	Parameter	Maximum			Unit
		2N3906 <sup>(3)</sup>	MMBT3906 <sup>(2)</sup>	PZT3906 <sup>(3)</sup>	
$P_D$	Total Device Dissipation	625	350	1,000	mW
	Derate Above $25^\circ\text{C}$	5.0	2.8	8.0	$\text{mW}/^\circ\text{C}$
$R_{\theta JC}$	Thermal Resistance, Junction to Case	83.3			$^\circ\text{C}/\text{W}$
$R_{\theta JA}$	Thermal Resistance, Junction to Ambient	200	357	125	$^\circ\text{C}/\text{W}$

### Notes:

- Device is mounted on FR-4 PCB 1.6 inch X 1.6 inch X 0.06 inch.
- PCB size: FR-4, 76 mm x 114 mm x 1.57 mm (3.0 inch x 4.5 inch x 0.062 inch) with minimum land pattern size.

## Electrical Characteristics

Values are at  $T_A = 25^\circ\text{C}$  unless otherwise noted.

Symbol	Parameter	Conditions	Min.	Max.	Unit
<b>OFF CHARACTERISTICS</b>					
$V_{(BR)CEO}$	Collector-Emitter Breakdown Voltage <sup>(4)</sup>	$I_C = -1.0\text{ mA}, I_B = 0$	-40		V
$V_{(BR)CBO}$	Collector-Base Breakdown Voltage	$I_C = -10\text{ }\mu\text{A}, I_E = 0$	-40		V
$V_{(BR)EBO}$	Emitter-Base Breakdown Voltage	$I_E = -10\text{ }\mu\text{A}, I_C = 0$	-5.0		V
$I_{BL}$	Base Cut-Off Current	$V_{CE} = -30\text{ V}, V_{BE} = 3.0\text{ V}$		-50	nA
$I_{CEX}$	Collector Cut-Off Current	$V_{CE} = -30\text{ V}, V_{BE} = 3.0\text{ V}$		-50	nA
<b>ON CHARACTERISTICS</b>					
$h_{FE}$	DC Current Gain <sup>(4)</sup>	$I_C = -0.1\text{ mA}, V_{CE} = -1.0\text{ V}$	60		
		$I_C = -1.0\text{ mA}, V_{CE} = -1.0\text{ V}$	80		
		$I_C = -10\text{ mA}, V_{CE} = -1.0\text{ V}$	100	300	
		$I_C = -50\text{ mA}, V_{CE} = -1.0\text{ V}$	60		
		$I_C = -100\text{ mA}, V_{CE} = -1.0\text{ V}$	30		
$V_{CE(sat)}$	Collector-Emitter Saturation Voltage	$I_C = -10\text{ mA}, I_B = -1.0\text{ mA}$		-0.25	V
		$I_C = -50\text{ mA}, I_B = -5.0\text{ mA}$		-0.40	
$V_{BE(sat)}$	Base-Emitter Saturation Voltage	$I_C = -10\text{ mA}, I_B = -1.0\text{ mA}$	-0.65	-0.85	V
		$I_C = -50\text{ mA}, I_B = -5.0\text{ mA}$		-0.95	
<b>SMALL SIGNAL CHARACTERISTICS</b>					
$f_T$	Current Gain - Bandwidth Product	$I_C = -10\text{ mA}, V_{CE} = -20\text{ V}, f = 100\text{ MHz}$	250		MHz
$C_{obo}$	Output Capacitance	$V_{CB} = -5.0\text{ V}, I_E = 0, f = 100\text{ kHz}$		4.5	pF
$C_{ibo}$	Input Capacitance	$V_{EB} = -0.5\text{ V}, I_C = 0, f = 100\text{ kHz}$		10.0	pF
NF	Noise Figure	$I_C = -100\text{ }\mu\text{A}, V_{CE} = -5.0\text{ V}, R_S = 1.0\text{ k}\Omega, f = 10\text{ Hz to }15.7\text{ kHz}$		4.0	dB
<b>SWITCHING CHARACTERISTICS</b>					
$t_d$	Delay Time	$V_{CC} = -3.0\text{ V}, V_{BE} = -0.5\text{ V}$		35	ns
$t_r$	Rise Time	$I_C = -10\text{ mA}, I_{B1} = -1.0\text{ mA}$		35	ns
$t_s$	Storage Time	$V_{CC} = -3.0\text{ V}, I_C = -10\text{ mA}, I_{B1} = I_{B2} = -1.0\text{ mA}$		225	ns
$t_f$	Fall Time			75	ns

**Note:**

4. Pulse test: pulse width  $\leq 300\text{ }\mu\text{s}$ , duty cycle  $\leq 2.0\%$ .

## Typical Performance Characteristics

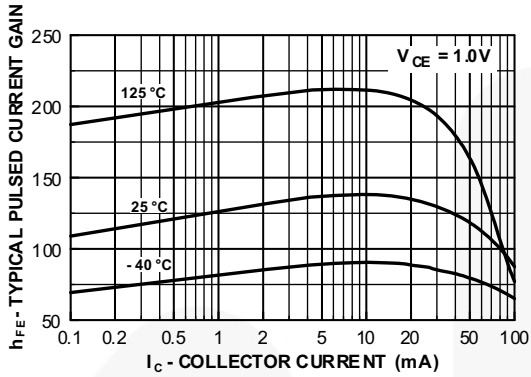

Figure 1. Typical Pulsed Current Gain vs. Collector Current

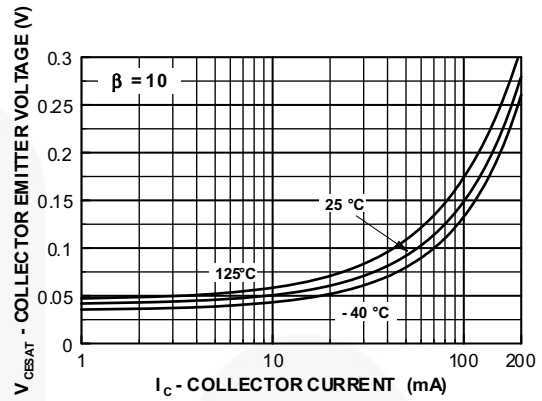

Figure 2. Collector-Emitter Saturation Voltage vs. Collector Current

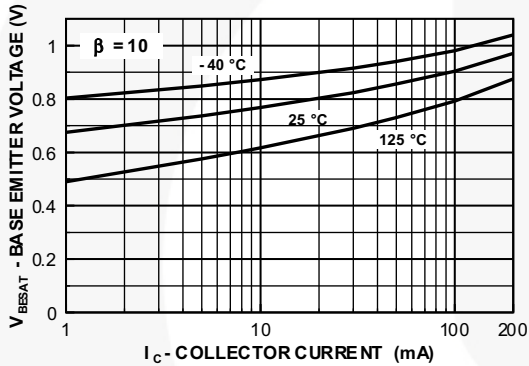

Figure 3. Base-Emitter Saturation Voltage vs. Collector Current

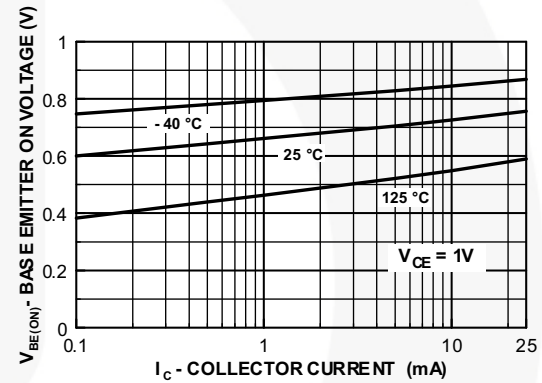

Figure 4. Base-Emitter On Voltage vs. Collector Current

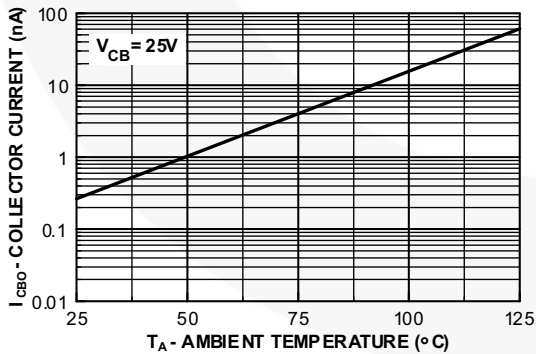

Figure 5. Collector Cut-Off Current vs. Ambient Temperature

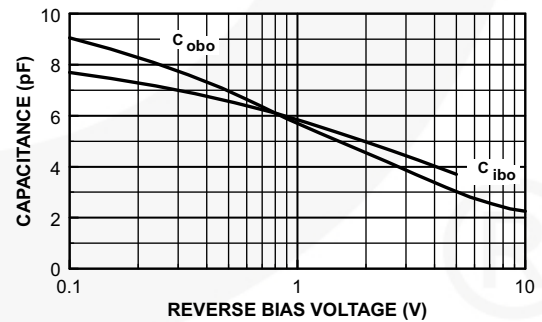

Figure 6. Common-Base Open Circuit Input and Output Capacitance vs. Reverse Bias Voltage

Typical Performance Characteristics (Continued)

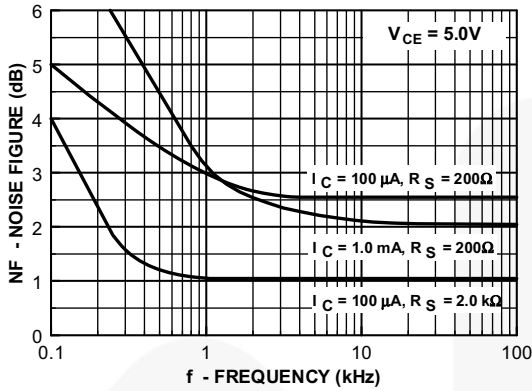

Figure 7. Noise Figure vs. Frequency

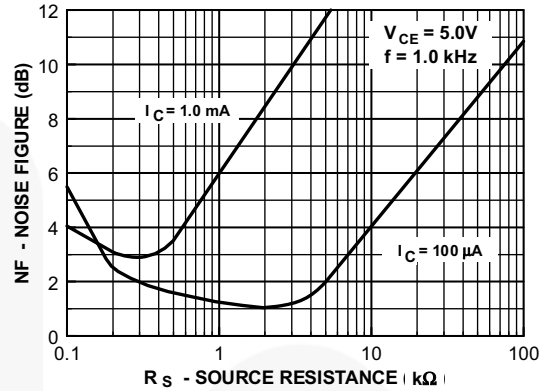

Figure 8. Noise Figure vs. Source Resistance

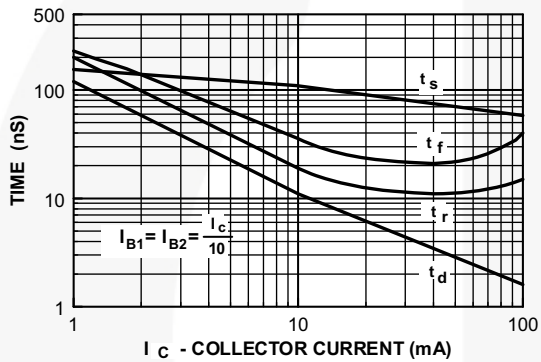

Figure 9. Switching Times vs. Collector Current

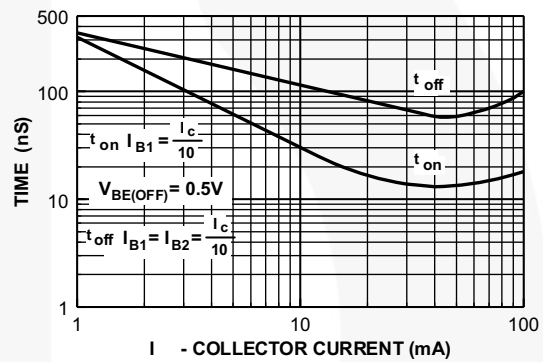

Figure 10. Turn-On and Turn-Off Times vs. Collector Current

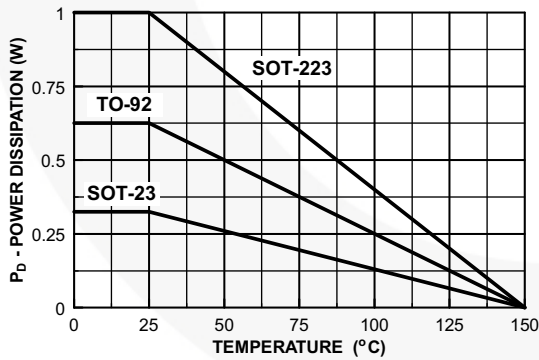

Figure 11. Power Dissipation vs. Ambient Temperature

Typical Performance Characteristics (Continued)

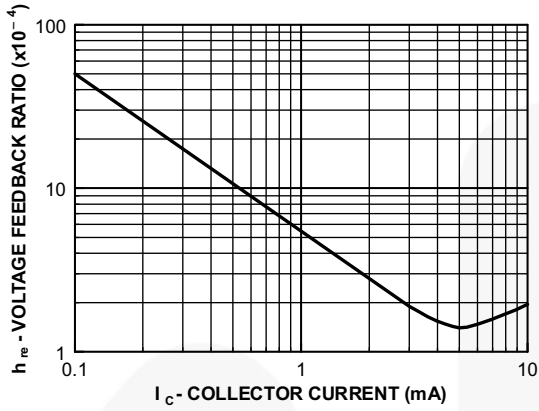

Figure 12. Voltage Feedback Ratio

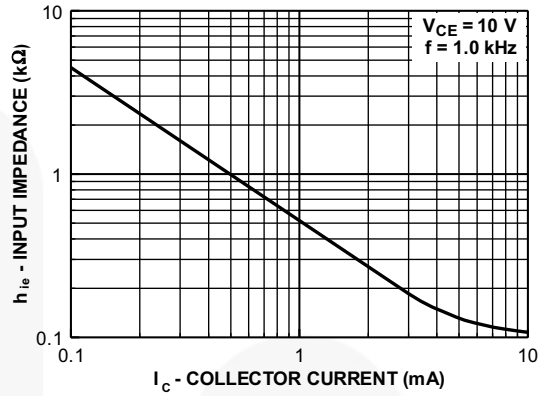

Figure 13. Input Impedance

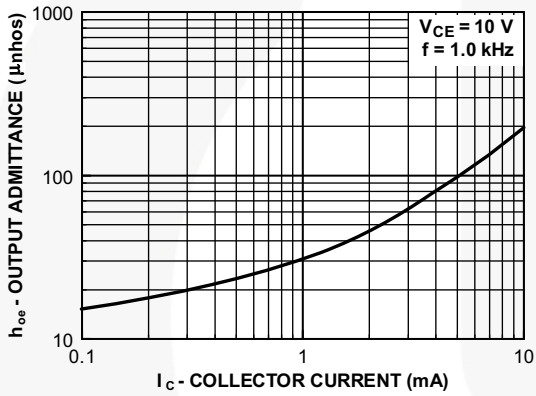

Figure 14. Output Admittance

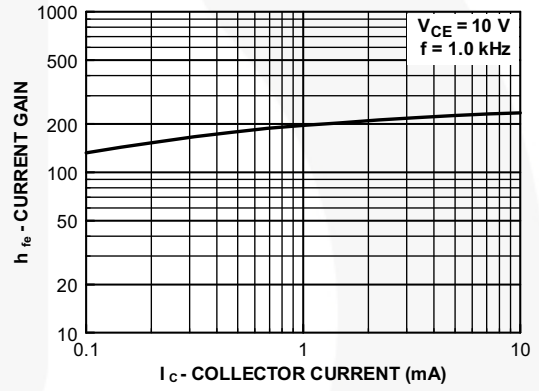
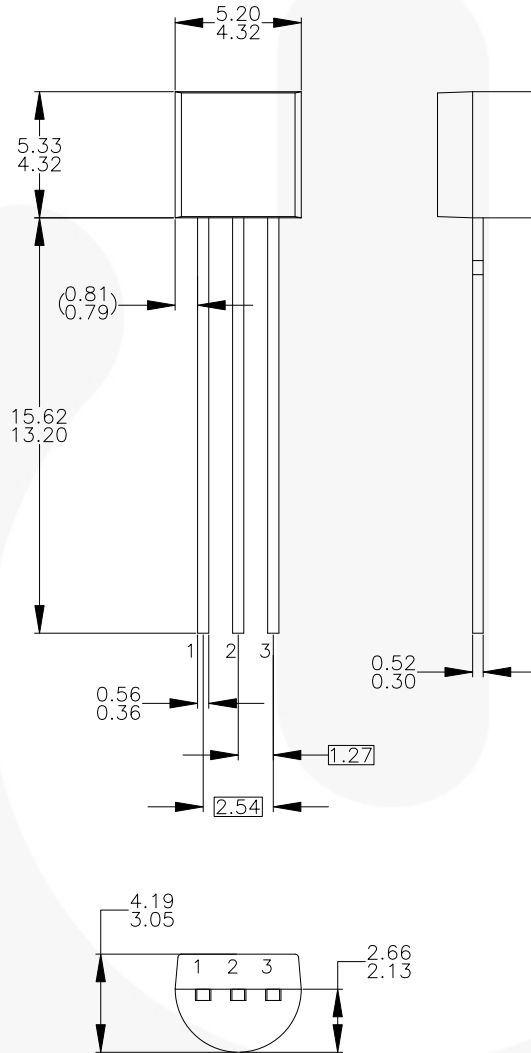

Figure 15. Current Gain

Physical Dimensions

TO-92 (Bulk)



NOTES: UNLESS OTHERWISE SPECIFIED

- A) DRAWING WITH REFERENCE TO JEDEC TO-92 RECOMMENDATIONS.
- B) ALL DIMENSIONS ARE IN MILLIMETERS.
- C) DRAWING CONFORMS TO ASME Y14.5M-1994.
- D) TO-92 (92,94,96,97,98) PIN CONFIGURATION:

PIN	92			94			96			97			98		
	P	F	M	P	F	M	B	F	M	P	F	M	P	F	M
1	E	S	S	E	S	S	B	D	G	C	G	D	C	G	D
2	B	D	G	C	G	D	E	S	S	B	D	G	E	S	S
3	C	G	D	B	D	G	C	G	D	E	S	S	B	D	G

LEGEND:

- P - BIPOLAR
- F - JFET
- M - DMOS
- E - EMITTER
- B - BASE
- C - COLLECTOR
- D - DRAIN
- S - SOURCE
- G - GATE

- E) FOR PACKAGE 92, 94, 96, 97 AND 98: PIN CONFIGURATION DRAIN "D" AND SOURCE "S" ARE INTERCHANGEABLE AT JFET "F" OPTION.
- F) DRAWING FILENAME: MKT-ZA03DREV3.

Figure 16. 3-LEAD, TO92, JEDEC TO-92 COMPLIANT STRAIGHT LEAD CONFIGURATION (OLD TO92AM3)

Package drawings are provided as a service to customers considering Fairchild components. Drawings may change in any manner without notice. Please note the revision and/or date on the drawing and contact a Fairchild Semiconductor representative to verify or obtain the most recent revision. Package specifications do not expand the terms of Fairchild's worldwide terms and conditions, specifically the warranty therein, which covers Fairchild products.

Always visit Fairchild Semiconductor's online packaging area for the most recent package drawings:

<http://www.fairchildsemi.com/dwg/ZA/ZA03D.pdf>

For current tape and reel specifications, visit Fairchild Semiconductor's online packaging area:

[http://www.fairchildsemi.com/packaging\\_dwg/PKG-ZA03D\\_BK.pdf](http://www.fairchildsemi.com/packaging_dwg/PKG-ZA03D_BK.pdf)



**Physical Dimensions** (Continued)

**TO-92 ( Ammo, Tape and Reel)**

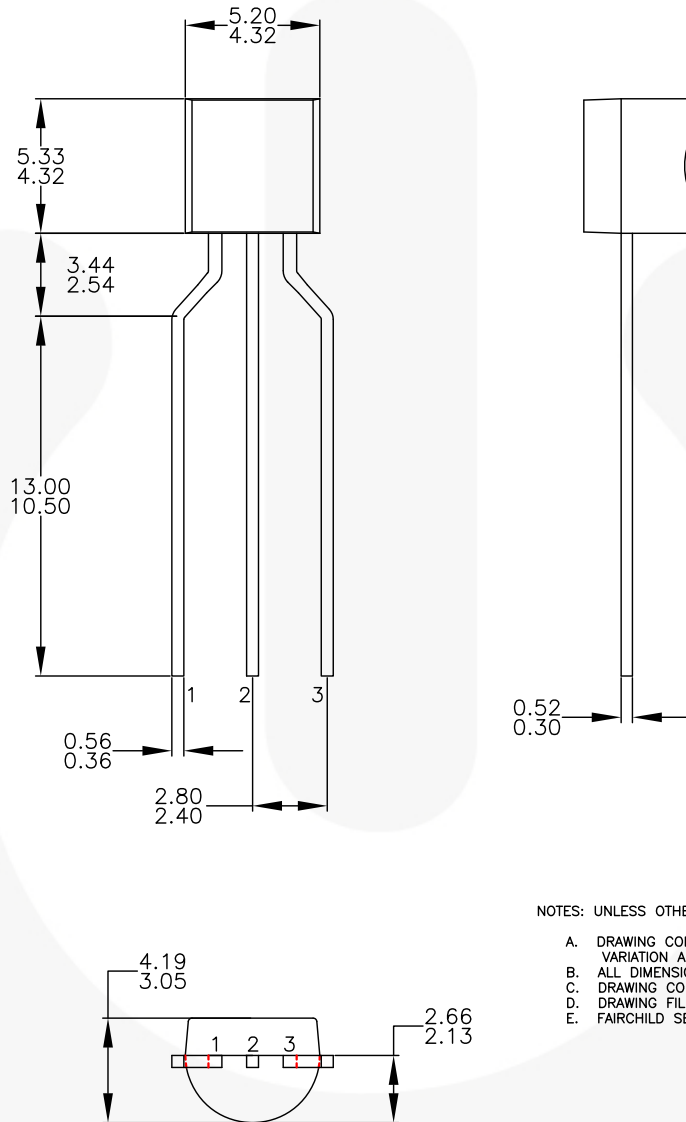

NOTES: UNLESS OTHERWISE SPECIFIED

- A. DRAWING CONFORMS TO JEDEC MS-013, VARIATION AC.
- B. ALL DIMENSIONS ARE IN MILLIMETERS.
- C. DRAWING CONFORMS TO ASME Y14.5M-2009.
- D. DRAWING FILENAME: MKT-ZA03FREV3.
- E. FAIRCHILD SEMICONDUCTOR.

**Figure 17. 3-LEAD, TO92, MOLDED 0.200 IN LINE SPACING LEAD FORM (J61Z OPTION)**

Package drawings are provided as a service to customers considering Fairchild components. Drawings may change in any manner without notice. Please note the revision and/or date on the drawing and contact a Fairchild Semiconductor representative to verify or obtain the most recent revision. Package specifications do not expand the terms of Fairchild's worldwide terms and conditions, specifically the warranty therein, which covers Fairchild products.

Always visit Fairchild Semiconductor's online packaging area for the most recent package drawings:  
<http://www.fairchildsemi.com/dwg/ZA/ZA03F.pdf>

For current tape and reel specifications, visit Fairchild Semiconductor's online packaging area:  
[http://www.fairchildsemi.com/packing\\_dwg/PKG-ZA03F\\_BK.pdf](http://www.fairchildsemi.com/packing_dwg/PKG-ZA03F_BK.pdf)

**Physical Dimensions** (Continued)

**SOT-23**

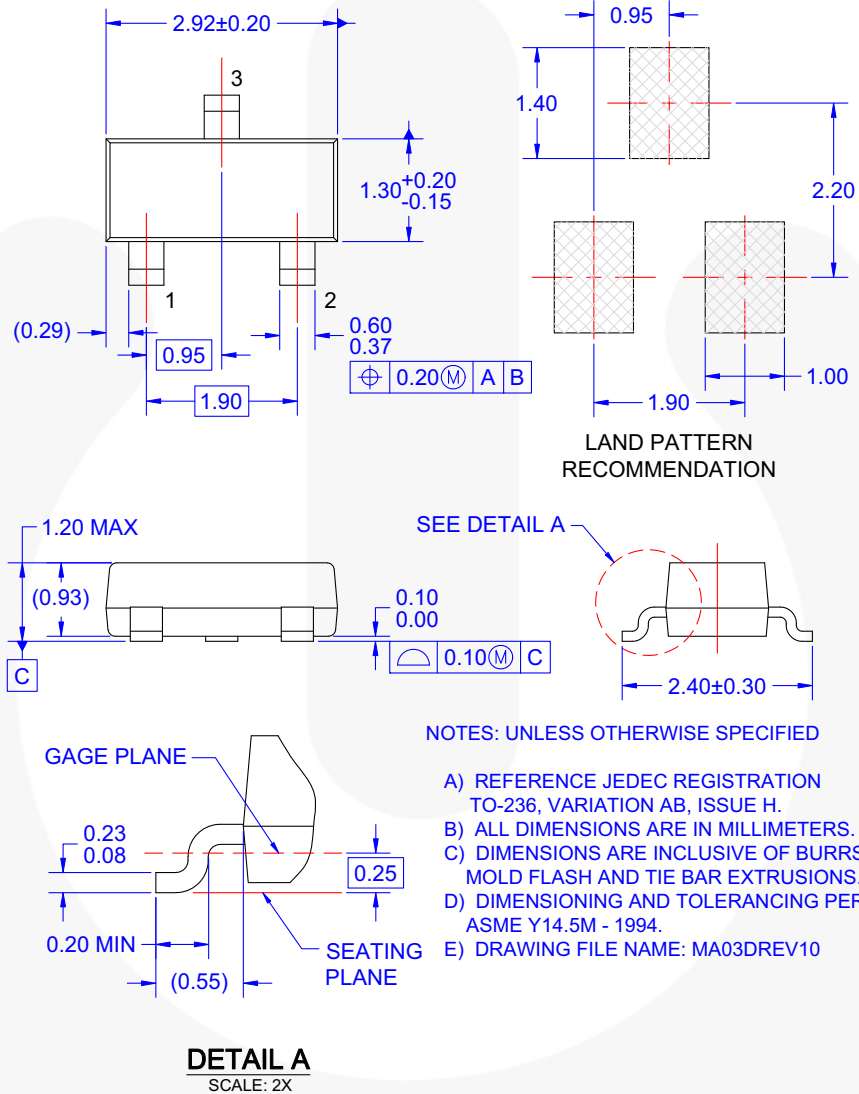

**Figure 18. 3-LEAD, SOT23, JEDEC TO-236, LOW PROFILE**

Package drawings are provided as a service to customers considering Fairchild components. Drawings may change in any manner without notice. Please note the revision and/or date on the drawing and contact a Fairchild Semiconductor representative to verify or obtain the most recent revision. Package specifications do not expand the terms of Fairchild's worldwide terms and conditions, specifically the warranty therein, which covers Fairchild products.

Always visit Fairchild Semiconductor's online packaging area for the most recent package drawings:  
<http://www.fairchildsemi.com/dwg/MA/MA03D.pdf>

For current tape and reel specifications, visit Fairchild Semiconductor's online packaging area:  
[http://www.fairchildsemi.com/packing\\_dwg/PKG-MA03D.pdf](http://www.fairchildsemi.com/packing_dwg/PKG-MA03D.pdf)

Physical Dimensions (Continued)

SOT-223 4L

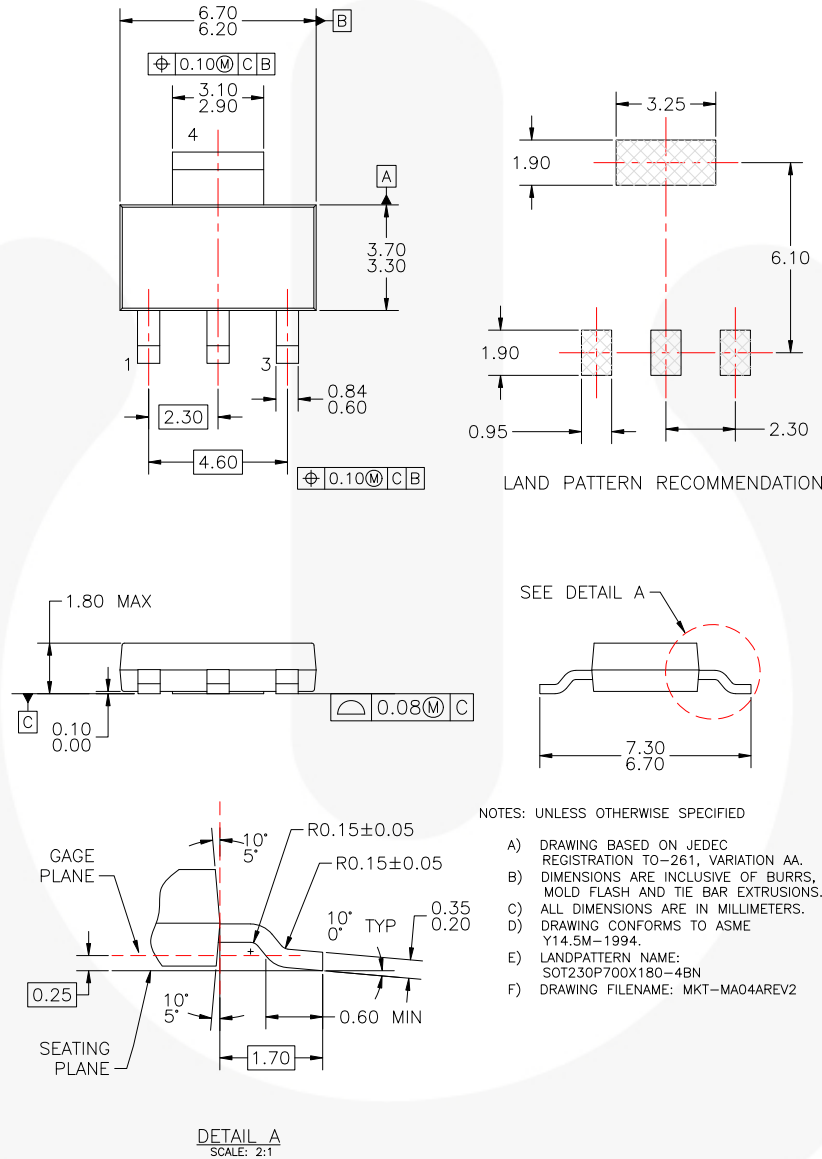

Figure 19. MOLDED PACKAGE, SOT-223, 4-LEAD

Package drawings are provided as a service to customers considering Fairchild components. Drawings may change in any manner without notice. Please note the revision and/or date on the drawing and contact a Fairchild Semiconductor representative to verify or obtain the most recent revision. Package specifications do not expand the terms of Fairchild's worldwide terms and conditions, specifically the warranty therein, which covers Fairchild products.

Always visit Fairchild Semiconductor's online packaging area for the most recent package drawings:

<http://www.fairchildsemi.com/dwg/MA04A.pdf>

For current tape and reel specifications, visit Fairchild Semiconductor's online packaging area:

[http://www.fairchildsemi.com/packaging\\_dwg/PKG-MA04A\\_BK.pdf](http://www.fairchildsemi.com/packaging_dwg/PKG-MA04A_BK.pdf)





## TRADEMARKS

The following includes registered and unregistered trademarks and service marks, owned by Fairchild Semiconductor and/or its global subsidiaries, and is not intended to be an exhaustive list of all such trademarks.

AccuPower™  
 AX-CAP®\*  
 BitSiC™  
 Build it Now™  
 CorePLUS™  
 CorePOWER™  
 CROSSVOLT™  
 CTL™  
 Current Transfer Logic™  
 DEUXPEED®  
 Dual Cool™  
 EcoSPARK®  
 EfficientMax™  
 ESBC™  
  
 Fairchild®  
 Fairchild Semiconductor®  
 FACT Quiet Series™  
 FACT®  
 FAST®  
 FastvCore™  
 FETBench™  
 FPS™

F-PFS™  
 FRFET®  
 Global Power Resource™  
 GreenBridge™  
 Green FPS™  
 Green FPS™ e-Series™  
 Gmax™  
 GTO™  
 IntelliMAX™  
 ISOPLANAR™  
 Making Small Speakers Sound Louder and Better™  
 MegaBuck™  
 MICROCOUPLER™  
 MicroFET™  
 MicroPak™  
 MicroPak2™  
 MillerDrive™  
 MotionMax™  
 mWSaver®  
 OptoHiT™  
 OPTOLOGIC®  
 OPTOPLANAR®

  
 PowerTrench®  
 PowerXS™  
 Programmable Active Droop™  
 QFET®  
 QS™  
 Quiet Series™  
 RapidConfigure™  
  
 Saving our world, 1mW/W/kW at a time™  
 SignalWise™  
 SmartMax™  
 SMART START™  
 Solutions for Your Success™  
 SPM®  
 STEALTH™  
 SuperFET®  
 SuperSOT™-3  
 SuperSOT™-6  
 SuperSOT™-8  
 SupreMOS®  
 SyncFET™  
 Sync-Lock™

  
 TinyBoost®  
 TinyBuck®  
 TinyCalc™  
 TinyLogic®  
 TINYOPTO™  
 TinyPower™  
 TinyPWM™  
 TinyWire™  
 TranSiC™  
 TriFault Detect™  
 TRUECURRENT®\*  
 μSerDes™  
  
 UHC®  
 Ultra FRFET™  
 UniFET™  
 VCX™  
 VisualMax™  
 VoltagePlus™  
 XS™  
 仙童™

\* Trademarks of System General Corporation, used under license by Fairchild Semiconductor.

## DISCLAIMER

FAIRCHILD SEMICONDUCTOR RESERVES THE RIGHT TO MAKE CHANGES WITHOUT FURTHER NOTICE TO ANY PRODUCTS HEREIN TO IMPROVE RELIABILITY, FUNCTION, OR DESIGN. FAIRCHILD DOES NOT ASSUME ANY LIABILITY ARISING OUT OF THE APPLICATION OR USE OF ANY PRODUCT OR CIRCUIT DESCRIBED HEREIN; NEITHER DOES IT CONVEY ANY LICENSE UNDER ITS PATENT RIGHTS, NOR THE RIGHTS OF OTHERS. THESE SPECIFICATIONS DO NOT EXPAND THE TERMS OF FAIRCHILD'S WORLDWIDE TERMS AND CONDITIONS, SPECIFICALLY THE WARRANTY THEREIN, WHICH COVERS THESE PRODUCTS.

## LIFE SUPPORT POLICY

FAIRCHILD'S PRODUCTS ARE NOT AUTHORIZED FOR USE AS CRITICAL COMPONENTS IN LIFE SUPPORT DEVICES OR SYSTEMS WITHOUT THE EXPRESS WRITTEN APPROVAL OF FAIRCHILD SEMICONDUCTOR CORPORATION.

As used herein:

1. Life support devices or systems are devices or systems which, (a) are intended for surgical implant into the body or (b) support or sustain life, and (c) whose failure to perform when properly used in accordance with instructions for use provided in the labeling, can be reasonably expected to result in a significant injury of the user.
2. A critical component in any component of a life support, device, or system whose failure to perform can be reasonably expected to cause the failure of the life support device or system, or to affect its safety or effectiveness.

## ANTI-COUNTERFEITING POLICY

Fairchild Semiconductor Corporation's Anti-Counterfeiting Policy. Fairchild's Anti-Counterfeiting Policy is also stated on our external website, [www.fairchildsemi.com](http://www.fairchildsemi.com), under Sales Support.

Counterfeiting of semiconductor parts is a growing problem in the industry. All manufacturers of semiconductor products are experiencing counterfeiting of their parts. Customers who inadvertently purchase counterfeit parts experience many problems such as loss of brand reputation, substandard performance, failed applications, and increased cost of production and manufacturing delays. Fairchild is taking strong measures to protect ourselves and our customers from the proliferation of counterfeit parts. Fairchild strongly encourages customers to purchase Fairchild parts either directly from Fairchild or from Authorized Fairchild Distributors who are listed by country on our web page cited above. Products customers buy either from Fairchild directly or from Authorized Fairchild Distributors are genuine parts, have full traceability, meet Fairchild's quality standards for handling and storage and provide access to Fairchild's full range of up-to-date technical and product information. Fairchild and our Authorized Distributors will stand behind all warranties and will appropriately address any warranty issues that may arise. Fairchild will not provide any warranty coverage or other assistance for parts bought from Unauthorized Sources. Fairchild is committed to combat this global problem and encourage our customers to do their part in stopping this practice by buying direct or from authorized distributors.

## PRODUCT STATUS DEFINITIONS

### Definition of Terms

Datasheet Identification	Product Status	Definition
Advance Information	Formative / In Design	Datasheet contains the design specifications for product development. Specifications may change in any manner without notice.
Preliminary	First Production	Datasheet contains preliminary data; supplementary data will be published at a later date. Fairchild Semiconductor reserves the right to make changes at any time without notice to improve design.
No Identification Needed	Full Production	Datasheet contains final specifications. Fairchild Semiconductor reserves the right to make changes at any time without notice to improve the design.
Obsolete	Not In Production	Datasheet contains specifications on a product that is discontinued by Fairchild Semiconductor. The datasheet is for reference information only.

Rev. I68

ON Semiconductor and  are trademarks of Semiconductor Components Industries, LLC dba ON Semiconductor or its subsidiaries in the United States and/or other countries. ON Semiconductor owns the rights to a number of patents, trademarks, copyrights, trade secrets, and other intellectual property. A listing of ON Semiconductor's product/patent coverage may be accessed at [www.onsemi.com/site/pdf/Patent-Marking.pdf](http://www.onsemi.com/site/pdf/Patent-Marking.pdf). ON Semiconductor reserves the right to make changes without further notice to any products herein. ON Semiconductor makes no warranty, representation or guarantee regarding the suitability of its products for any particular purpose, nor does ON Semiconductor assume any liability arising out of the application or use of any product or circuit, and specifically disclaims any and all liability, including without limitation special, consequential or incidental damages. Buyer is responsible for its products and applications using ON Semiconductor products, including compliance with all laws, regulations and safety requirements or standards, regardless of any support or applications information provided by ON Semiconductor. "Typical" parameters which may be provided in ON Semiconductor data sheets and/or specifications can and do vary in different applications and actual performance may vary over time. All operating parameters, including "Typicals" must be validated for each customer application by customer's technical experts. ON Semiconductor does not convey any license under its patent rights nor the rights of others. ON Semiconductor products are not designed, intended, or authorized for use as a critical component in life support systems or any FDA Class 3 medical devices or medical devices with a same or similar classification in a foreign jurisdiction or any devices intended for implantation in the human body. Should Buyer purchase or use ON Semiconductor products for any such unintended or unauthorized application, Buyer shall indemnify and hold ON Semiconductor and its officers, employees, subsidiaries, affiliates, and distributors harmless against all claims, costs, damages, and expenses, and reasonable attorney fees arising out of, directly or indirectly, any claim of personal injury or death associated with such unintended or unauthorized use, even if such claim alleges that ON Semiconductor was negligent regarding the design or manufacture of the part. ON Semiconductor is an Equal Opportunity/Affirmative Action Employer. This literature is subject to all applicable copyright laws and is not for resale in any manner.

## PUBLICATION ORDERING INFORMATION

### LITERATURE FULFILLMENT:

Literature Distribution Center for ON Semiconductor  
19521 E. 32nd Pkwy, Aurora, Colorado 80011 USA  
**Phone:** 303-675-2175 or 800-344-3860 Toll Free USA/Canada  
**Fax:** 303-675-2176 or 800-344-3867 Toll Free USA/Canada  
**Email:** [orderlit@onsemi.com](mailto:orderlit@onsemi.com)

**N. American Technical Support:** 800-282-9855 Toll Free  
USA/Canada  
**Europe, Middle East and Africa Technical Support:**  
Phone: 421 33 790 2910  
**Japan Customer Focus Center**  
Phone: 81-3-5817-1050

**ON Semiconductor Website:** [www.onsemi.com](http://www.onsemi.com)  
**Order Literature:** <http://www.onsemi.com/orderlit>  
For additional information, please contact your local  
Sales Representative