

Film, Metallized Polyester Stacked, Commercial Grade, R82, 3300 pF, 10%, 400 V, 85C, Lead Spacing = 5mm

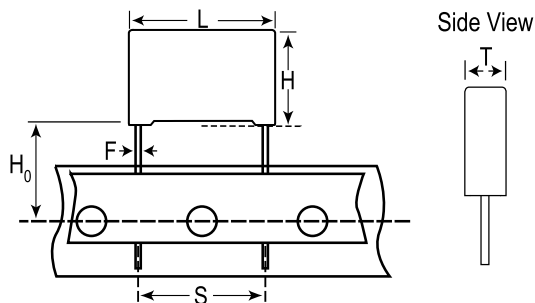

General Information	
<b>Dielectric:</b>	Metallized Polyester Stacked
<b>Style:</b>	Radial
<b>Series:</b>	R82
<b>Features:</b>	Pulse
<b>RoHS:</b>	Yes
<b>Lead:</b>	Wire Leads
<b>Approvals:</b>	AEC-Q200
<b>AEC-Q200:</b>	Yes
<b>Miscellaneous:</b>	Above 85C DC And AC Voltage Derating Is 1.25%/C

Dimensions	
<b>L</b>	7.2mm +0.2mm
<b>H</b>	6.5mm +0.1mm
<b>T</b>	2.5mm +0.1mm
<b>S</b>	5mm +/-0.4mm
<b>H0</b>	18.5mm +/-0.5mm
<b>F</b>	0.5mm +/-0.05mm

Specifications	
<b>Capacitance:</b>	3300 pF
<b>Capacitance Tolerance:</b>	10%
<b>Voltage DC:</b>	400 VDC
<b>Voltage AC:</b>	200 VAC
<b>Temperature Range:</b>	-55/+105C
<b>Rated Temperature:</b>	85C
<b>Dissipation Factor:</b>	0.8% 1kHz, 1.2% 10kHz, 2.5% 100kHz
<b>Insulation Resistance:</b>	30 GOhms
<b>Max dVdt:</b>	400 V
<b>Inductance:</b>	7 nH

Packaging Specifications	
<b>Packaging:</b>	Ammo, 360x340x59mm, Box
<b>Packaging Quantity:</b>	3500