

PLEASE CHECK WWW.MOLEX.COM FOR LATEST PART INFORMATION

Part Number: [5013301500](#)
Status: **Active**
Overview: Pico-Clasp™ Wire-to-Board Connectors
Description: 1.00mm Pitch Pico-Clasp™ Wire-to-Board Female Housing, Single Row, with Positive Lock, 15 Circuits

Documents:

[3D Model](#) [RoHS Certificate of Compliance \(PDF\)](#)
[Drawing \(PDF\)](#)

Agency Certification

UL E29179

General

Product Family Crimp Housings
 Series [501330](#)
 Application Signal, Wire-to-Board
 Overview [Pico-Clasp™ Wire-to-Board Connectors](#)
 Product Name Pico-Clasp™
 UPC 822348529001

Physical

Circuits (maximum) 15
 Color - Resin White
 Gender Female
 Glow-Wire Compliant No
 Lock to Mating Part Yes
 Material - Resin Nylon
 Net Weight 118.600/mg
 Number of Rows 1
 Packaging Type Bag
 Panel Mount No
 Pitch - Mating Interface 1.00mm
 Polarized to Mating Part Yes
 Stackable No
 Temperature Range - Operating -40°C to +105°C

Electrical

Current - Maximum per Contact 1.0A

Material Info

Reference - Drawing Numbers

Product Specification RPS-501568-010
 Sales Drawing SD-501330-002

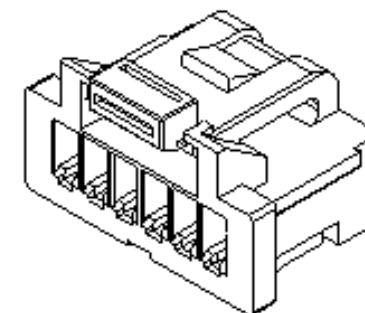

Series image - Reference only

EU ELV

Not Relevant

EU RoHS

Compliant

China RoHS

REACH SVHC

Not Contained Per -
 ED/21/2016 (20 June
 2016)

Halogen-Free

Status

Low-Halogen

**Need more information on product
 environmental compliance?**

Email productcompliance@molex.com
 Please visit the [Contact Us](#) section for any
 non-product compliance questions.

China ROHS
 ELV

Green Image
 Not Relevant

Search Parts in this Series

[501330](#) Series

Mates With

[501331](#) PCB Header . [501568](#) PCB Header

Use With

[501334](#) Crimp Terminal