

PLEASE CHECK WWW.MOLEX.COM FOR LATEST PART INFORMATION

Part Number: [5022502391](#)
Status: **Active**
Overview: FFC-FPC (SMT)
Description: 0.30mm Pitch Easy-On™ BackFlip™ Type FPC Connector, Right Angle, Surface Mount, Dual Contact Style, 0.90mm Mated Height, 23 Circuits

Documents:

[3D Model](#) [RoHS Certificate of Compliance \(PDF\)](#)
[Drawing \(PDF\)](#)

General

Product Family	FFC/FPC Connectors
Series	502250
Overview	FFC-FPC (SMT)
Product Name	Easy-On™
UPC	883906039424

Physical

Circuits (Loaded)	23
Color - Resin	Black, Natural
Contact Position	Dual
Durability (mating cycles max)	10
Entry Angle	90° Angle
Mated Height	0.90mm
Material - Metal	Copper-Nickel-Tin
Material - Plating Mating	Gold
Material - Plating Termination	Gold
Net Weight	53.974/mg
Number of Rows	1
Orientation	Right Angle
PCB Locator	No
PCB Retention	Yes
Packaging Type	Embossed Tape on Reel
Pitch - Mating Interface	0.30mm
Polarized to PCB	Yes
Stackable	No
Temperature Range - Operating	-40°C to +105°C
Termination Interface: Style	Surface Mount
Wire/Cable Type	FPC only

Electrical

Current - Maximum per Contact	0.2A
Voltage - Maximum	50V AC (RMS)/DC

Material Info

Reference - Drawing Numbers

Sales Drawing	5022500000, 5022501000
---------------	------------------------

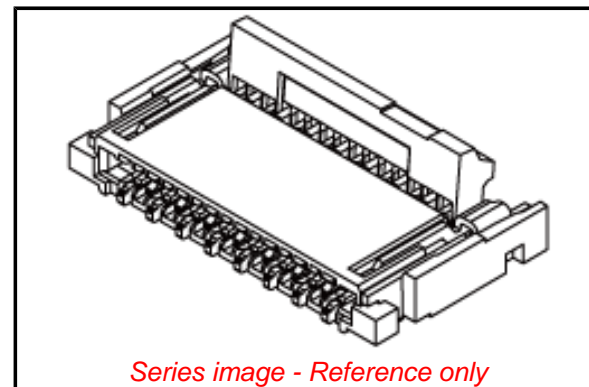

Series image - Reference only

EU ELV

Not Relevant

EU RoHS

Compliant

REACH SVHC

Not Contained Per -
ED/21/2016 (20 June
2016)

Halogen-Free

Status

Not Low-Halogen

**Need more information on product
environmental compliance?**

Email productcompliance@molex.com
Please visit the [Contact Us](#) section for any
non-product compliance questions.

China ROHS

ELV

Green Image

Not Relevant

Search Parts in this Series

[502250](#) Series