

PLEASE CHECK WWW.MOLEX.COM FOR LATEST PART INFORMATION

Part Number: [0527451297](#)
Status: **Active**
Overview: FFC-FPC (SMT)
Description: 0.50mm Pitch Easy-On™ Type FFC/FPC Connector, Right Angle, Surface Mount, ZIF, Top Contact Style, 12 Circuits, Gold (Au) Contact Plating, High Barrier Packaging

Documents:

[3D Model](#) [RoHS Certificate of Compliance \(PDF\)](#)
[Drawing \(PDF\)](#)

Agency Certification

UL E29179

General

Product Family FFC/FPC Connectors
 Series [52745](#)
 Overview [FFC-FPC \(SMT\)](#)
 Product Name Easy-On™
 UPC 822348250509

Physical

Circuits (Loaded) 12
 Color - Resin Black, White
 Contact Position Top
 Durability (mating cycles max) 20
 Entry Angle 90° Angle
 Flammability 94V-0
 Mated Height 2.00mm
 Material - Metal Phosphor Bronze
 Material - Plating Mating Gold
 Material - Plating Termination Gold
 Net Weight 174.598/mg
 Number of Rows 1
 Orientation Right Angle
 PCB Locator No
 PCB Retention Yes
 Packaging Type Embossed Tape on Reel
 Pitch - Mating Interface 0.50mm
 Polarized to PCB Yes
 Stackable No
 Temperature Range - Operating -40°C to +85°C
 Termination Interface: Style Surface Mount
 Wire/Cable Type FFC/FPC

Electrical

Current - Maximum per Contact 0.5A
 Voltage - Maximum 50V

Material Info

Reference - Drawing Numbers

Sales Drawing SD-52745-050, SD-52745-051

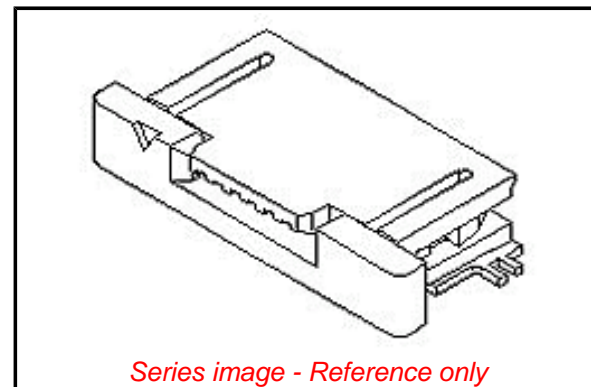

Series image - Reference only

EU ELV

Not Relevant

EU RoHS

Compliant

REACH SVHC

Not Contained Per -
 ED/21/2016 (20 June
 2016)

Halogen-Free

Status

Not Low-Halogen

**Need more information on product
 environmental compliance?**

Email productcompliance@molex.com
 Please visit the [Contact Us](#) section for any
 non-product compliance questions.

China ROHS

ELV

Green Image

Not Relevant

Search Parts in this Series

[52745](#) Series

Mates With

Molex Premo-Flex FFC. Be sure to match like plating