

PLEASE CHECK WWW.MOLEX.COM FOR LATEST PART INFORMATION

Part Number: [0512811294](#)
Status: **Active**
Overview: FFC-FPC (SMT)
Description: Easy-On™ Type FFC/FPC Connector, Right-Angle, Surface Mount, Non-ZIF, Dual Contact Style, 1.20mm Mated Height, 12 Circuits, Gold (Au) Plating

Documents:

[3D Model](#) [RoHS Certificate of Compliance \(PDF\)](#)
[Drawing \(PDF\)](#)

General

Product Family	FFC/FPC Connectors
Series	51281
Overview	FFC-FPC (SMT)
Product Name	Easy-On™
UPC	822348700042

Physical

Circuits (Loaded)	12
Color - Resin	Natural
Contact Position	Dual
Durability (mating cycles max)	20
Entry Angle	90° Angle
Mated Height	1.20mm
Material - Metal	Phosphor Bronze
Material - Plating Mating	Gold
Material - Plating Termination	Tin
Net Weight	80.536/mg
Number of Rows	1
Orientation	Right Angle
PCB Locator	No
PCB Retention	Yes
Packaging Type	Embossed Tape on Reel
Pitch - Mating Interface	0.50mm
Plating min - Mating	0.102µm
Plating min - Termination	1.016µm
Polarized to PCB	Yes
Stackable	No
Surface Mount Compatible (SMC)	N/A
Temperature Range - Operating	-20°C to +85°C
Termination Interface: Style	Surface Mount
Wire/Cable Type	FFC/FPC

Electrical

Current - Maximum per Contact	0.5A
Voltage - Maximum	50V

Material Info

Reference - Drawing Numbers

Sales Drawing SD-51281-011, SD-51281-012

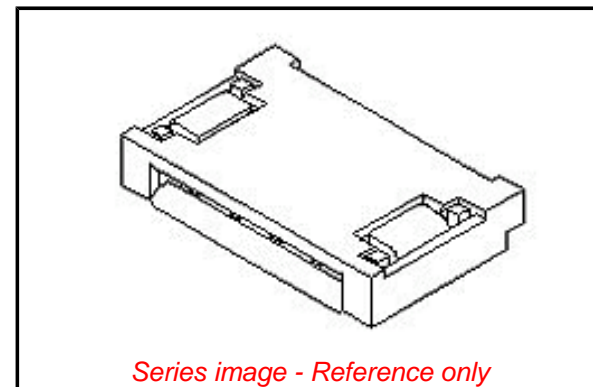

Series image - Reference only

EU ELV

Not Relevant

EU RoHS

Compliant

China RoHS

REACH SVHC

Not Contained Per -
ED/21/2016 (20 June
2016)

Halogen-Free

Status

Low-Halogen

Need more information on product environmental compliance?

Email productcompliance@molex.com
Please visit the [Contact Us](#) section for any non-product compliance questions.

China ROHS

ELV

Green Image

Not Relevant

Search Parts in this Series

[51281 Series](#)

Mates With

Molex Premo-Flex FFC. Be sure to match like plating