



Short form catalogue

Industrial accessories Industrial plugs & sockets

Industrial accessories

Industrial plugs & sockets



Contents

Overview	4
Easy & Safe	5
Tough & Safe	6
Critical & Safe	7
Plugs	8
Connectors	11
Sockets	14
Inlets	17
Panel mounted sockets	20
Switched interlocked sockets	22
Switched interlocked sockets with protection	25
Plugs & sockets for entertainment overview	26
Plugs, connectors, sockets	27
Kombi modules	28

Industrial Plugs & Sockets Overview

Industrial plugs and sockets are often small details in electrical installations small details that can boost productivity, process reliability and ultimately safety. By choosing ABB's industrial plugs and sockets, this difference could not be any clearer. They are the most user-friendly and economical insurance to your equipment there is. They benefit you in the background, letting you concentrate on the real work. Just like it should be.

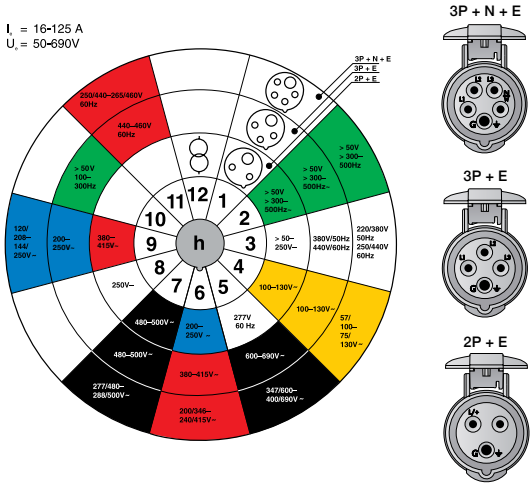
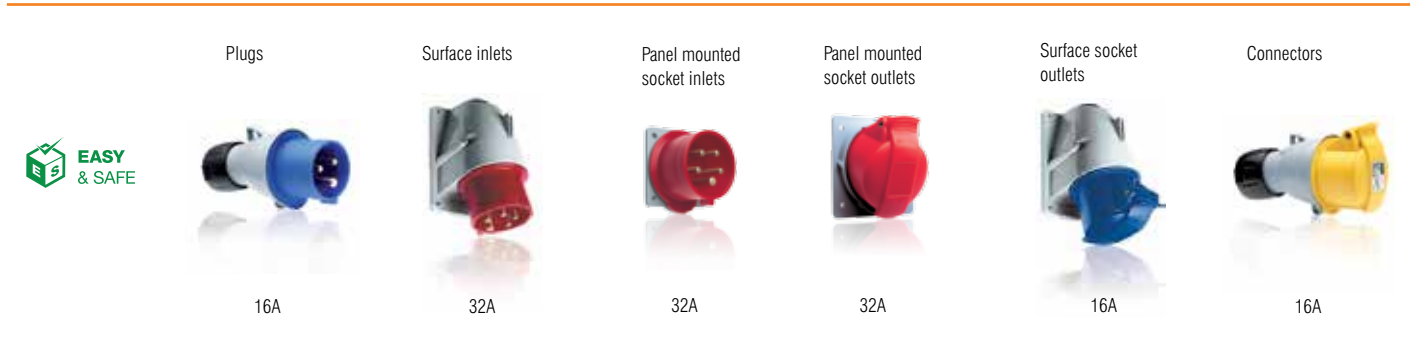

The easiest solution to making even the most complex installation

Without compromising quality, the Easy & Safe range is our basic offering. For temporary power outtake to permanent installation, the tough and safe range is up and running in no time.

Features

- IP44 Splash proof
- 16 - 32 A, 50 - 690 VAC
- PA6 plastic material
- IEC 60 309-1, -2
- Ergonomic design

Non-decaying plastic increases plug and socket lifetime

Ergonomic design simplifies handling and allows for more frequent connections.

Connection seals ensures there are no interruptions to your temporary power feed.

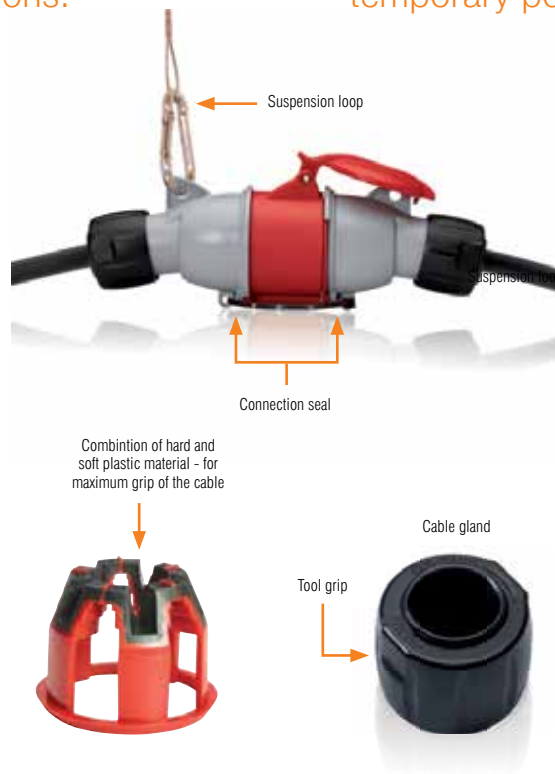
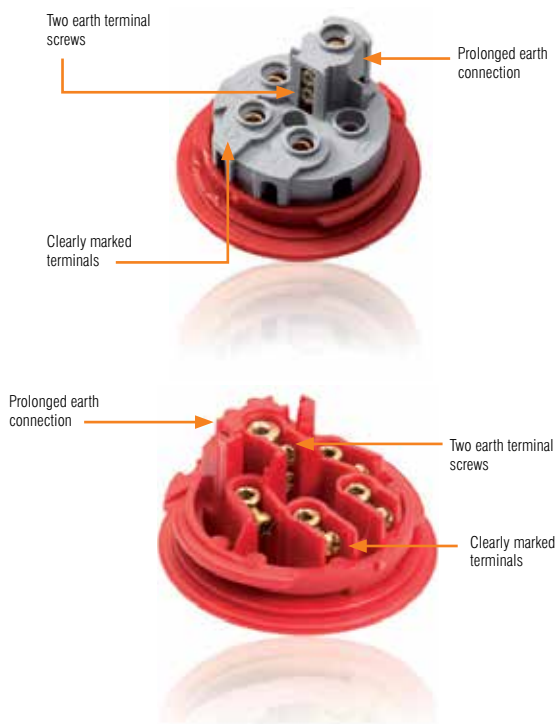

Keeping the mall clean

A key factor in making a one-time visitor at the mall a returning visitor is making a good impression by keeping the mall clean. Big vacuumers, floor cleaning machines and other equipment need reliable temporary power supply. ABB's Easy & Safe range is quick and easy to connect and offers increased reliability during operation. It even protects the equipment in events of a splash from the nearby in-mall fountain.



Industrial plugs & sockets

Tough & Safe



Tough & Safe is the range for applications in environments that have high demand of functionality and safety. The robust housing is made of PBT plastic. The range Tough & Safe is available as watertight (IP67, 16 - 125A) and splash proof (IP44, 63A). The devices are equipped with internal and external cable clamps. The 125A devices are equipped with two screws on each terminal.

Features

- IP67 Watertight or IP44 Splash proof
- 16 - 125 A, 50 - 690 VAC
- IEC 60 309-1, -2
- All external screws are made of stainless steel.

Application examples

- Industry / workshops
- Harbours / shipyards
- Mines
- Food & beverage

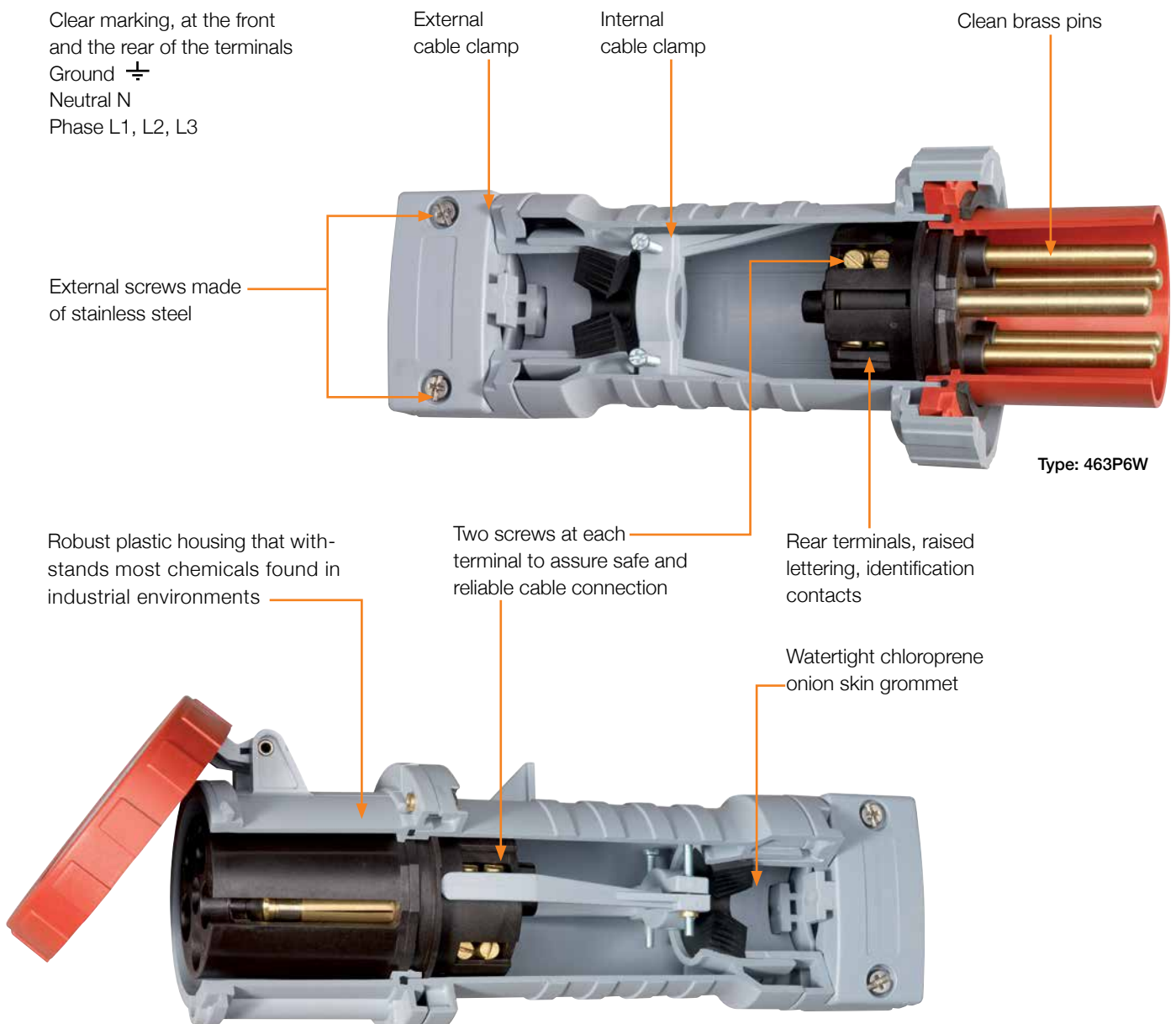

Industrial plugs & sockets

Critical & Safe



Critical & Safe is the range for applications with high demands on safety, durability and performance. Perfect for applications with frequent connection / disconnection, and to use in public areas.

The housing is made of PBT or aluminum. PBT is a tough plastic material that withstands heavy-duty usage and most chemicals found in industrial environments. The aluminum housing is a mix of aluminium and silicon called Silumin, which gives an excellent protection against corrosion while being robust and tough against impact and sun light.

Features

- IP67 Watertight or IP44 Splash proof
- 16 - 125 A, 50 - 690 VAC
- IEC 60 309-2, -4
- All external screws are made of stainless steel

Application examples

- Heavy / chemical industry
- Sawmills
- Airports
- Hospitals

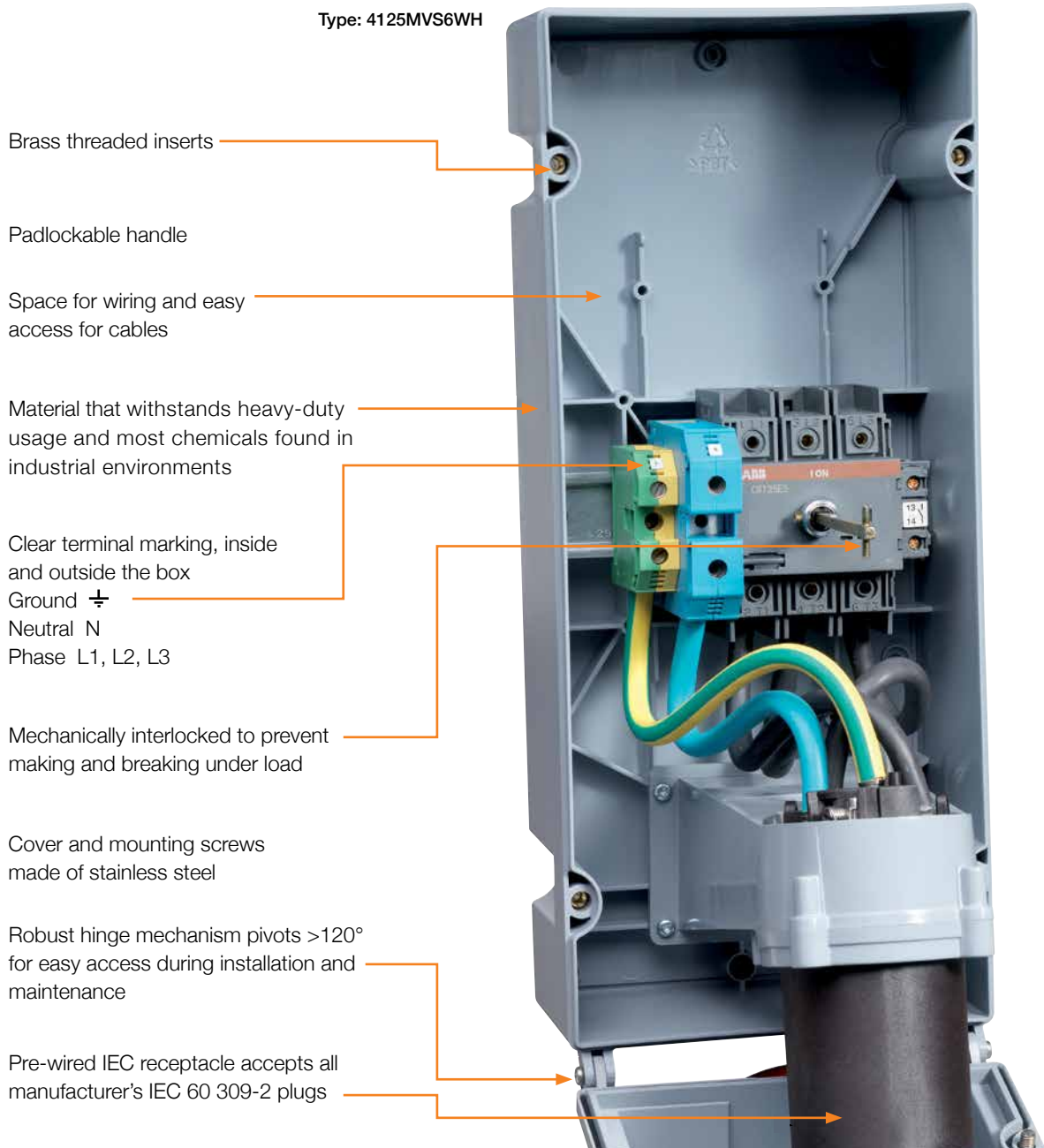

Industrial plugs & sockets

Plugs - splash proof IP44

16A, IP44 Splash proof Thermoplastic



Cable entry with compression gland. Cable area 1 - 2.5mm²

Type	Terminals/Poles	Colour Code	Voltage V	Part No	Product Hierarchy 0000900003 Order Code
2P+E	3	Yellow	100-130	216-P4*	2CMA193500R1000
		Blue	200-250	216-P9*	2CMA193501R1000
3P+E	4	Yellow	100-130	316-P4*	2CMA193504R1000
		Black	600-690	316-P5*	2CMA193505R1000
		Black	480-500	316-P7*	2CMA193507R1000
		Blue	200-250	316-P9*	2CMA193508R1000
		Red	440-460	316-P11*	2CMA193509R1000
3P+N+E	5	Red	346-415	416-P6*	2CMA193511R1000

32A, IP44 Splash proof Thermoplastic



Cable entry with compression gland. Cable area 2.5 - 6mm²

Type	Terminals/Poles	Colour Code	Voltage V	Part No	Product Hierarchy 0000900003 Order Code
2P+E	3	Yellow	100-130	232-P4*	2CMA193512R1000
		Blue	200-250	232-P6*	2CMA193513R1000
3P+E	4	Black	600-690	332-P5	2CMA193514R1000
		Red	380-415	332-P6*	2CMA193515R1000
		Black	480-500	332-P7*	2CMA193516R1000
		Blue	200-250	332-P9*	2CMA193517R1000
		Red	440-460	332-P11*	2CMA193518R1000
3P+N+E	5	Red	346-415	432-P6*	2CMA193519R1000

63A, IP44 Splash proof Thermoplastic



Cable entry with compression gland. Cable area 4 - 16mm²

Type	Terminals/Poles	Colour Code	Voltage V	Part No	Product Hierarchy 0000900003 Order Code
2P+E	3	Yellow	100-130	263-P4	2CMA166740R1000
		Blue	200-250	263-P6*	2CMA166742R1000
3P+E	4	Black	600-690	363-P5	2CMA166750R1000
		Red	380-415	363-P6*	2CMA166752R1000
		Black	480-500	363-P7*	2CMA166754R1000
		Blue	200-250	363-P9	2CMA166756R1000
		Red	346-415	463-P6*	2CMA166764R1000

* Indicates standard product.

Industrial plugs & sockets

Plugs - watertight IP67

16 A, IP67 Watertight Plastic enclosure (PBT)



Cable entry with compression gland. Cable area 1 - 2.5mm²

Type	Terminals/Poles	Colour Code	Voltage V	Part No	Product Hierarchy 0000900003 Order Code
2P+E	3	Yellow	100-130	216-P4W*	2CMA166458R1000
		Blue	200-250	216-P6W*	2CMA166460R1000
3P+E	4	Yellow	100-130	316-P4W	2CMA166472R1000
		Black	600-690	316-P5W*	2CMA166474R1000
		Red	380-415	316-P6W*	2CMA166476R1000
		Black	480-500	316-P7W	2CMA166478R1000
		Blue	200-250	316-P9W	2CMA166482R1000
3P+N+E	5	Yellow	100-130	416-P4W	2CMA166492R1000
		Red	346-415	416-P6W*	2CMA166500R1000
		Blue	200-250	416-P9W	2CMA166498R1000

32 A, IP67 Watertight Plastic enclosure (PBT)



Cable entry with compression gland. Cable area 2.5-6 mm²

Type	Terminals/Poles	Colour Code	Voltage V	Part No	Product Hierarchy 0000900003 Order Code
2P+E	3	Yellow	100-130	232-P4W	2CMA166504R1000
		Blue	200-250	232-P6W*	2CMA166722R1000
3P+E	4	Yellow	100-130	332-P4W	2CMA166734R1000
		Black	600-690	332-P5W	2CMA166736R1000
		Red	380-415	332-P6W*	2CMA166513R1000
		Black	480-500	332-P7W	2CMA166506R1000
		Blue	200-250	332-P9W	2CMA166508R1000
3P+N+E	5	Yellow	100-130	432-P4W	2CMA166522R1000
		Red	346-415	432-P6W*	2CMA166524R1000
		Blue	200-250	432-P9W	2CMA166528R1000

63 A, IP67 Watertight Plastic enclosure (PBT)



Cable entry with compression gland, internal and external cable clamp. Cable area 4-16 mm²

Type	Terminals/Poles	Colour Code	Voltage V	Part No	Product Hierarchy 0000900003 Order Code
2P+E	3	Yellow	100-130	263-P4W	2CMA166774R1000
		Blue	200-250	263-P6W	2CMA166776R1000
3P+E	4	Yellow	100-130	363-P4W	2CMA166782R1000
		Black	600-690	363-P5W	2CMA166784R1000
		Red	380-415	363-P6W*	2CMA166792R1000
		Black	480-500	363-P7W	2CMA166788R1000
		Blue	200-250	363-P9W	2CMA166790R1000
3P+N+E	5	Yellow	100-130	463-P4W	2CMA166796R1000
		Red	380-415	463-P6W	2CMA166798R1000
		Blue	200-250	463-P9W	2CMA166802R1000

* Indicates standard product.

Industrial plugs & sockets

Plugs - watertight IP67

125 A, IP67 Watertight
Plastic enclosure (PBT)



Cable entry with compression gland, internal and external cable clamp. Cable area 16-50 mm²



Type	Terminals/Poles	Colour Code	Voltage V	Part No	Product Hierarchy 0000900003 Order Code
2P+E	3	Yellow	100-130	2125-P4W	2CMA166808R1000
		Blue	200-250	2125-P6W	2CMA166810R1000
3P+E	4	Yellow	100-130	3125-P4W	2CMA166824R1000
		Black	600-690	3125-P5W	2CMA166814R1000
		Red	380-415	3125-P6W*	2CMA166816R1000
		Black	480-500	3125-P7W	2CMA166818R1000
		Blue	200-250	3125-P9W	2CMA166820R1000
3P+N+E	5	Yellow	100-130	4125-P4W	2CMA166826R1000
		Red	380-415	4125-P6W*	2CMA166828R1000
		Blue	200-250	4125-P9W	2CMA166832R1000

* Indicates standard product.

Industrial plugs & sockets

Connectors - splash proof IP44

16A, IP44 Splash proof Thermoplastic



Cable entry with compression gland. Cable area 1 - 2.5mm²

Type	Terminals/Poles	Colour Code	Voltage V	Part No	Product Hierarchy 0000900003 Order Code
2P+E	3	Yellow	100-130	216-C4*	2CMA193520R1000
		Blue	200-250	216-C9*	2CMA193521R1000
3P+E	4	Yellow	100-130	316-C4*	2CMA193522R1000
		Red	380-415	316-C6*	2CMA193523R1000
		Black	480-500	316-C7*	2CMA193524R1000
		Blue	200-250	316-C9*	2CMA193525R1000
3P+N+E	5	Red	346-415	416-C6*	2CMA193526R1000

32A, IP44 Splash proof Thermoplastic



Cable entry with compression gland. Cable area 2.5 - 6mm²

Type	Terminals/Poles	Colour Code	Voltage V	Part No	Product Hierarchy 0000900003 Order Code
2P+E	3	Yellow	100-130	232-C4	2CMA193527R1000
		Blue	200-250	232-C6*	2CMA193528R1000
3P+E	4	Black	600-690	332-C5	2CMA193533R1000
		Red	380-415	332-C6*	2CMA193529R1000
		Black	480-500	332-C7*	2CMA193534R1000
		Blue	200-250	332-C9*	2CMA193530R1000
3P+N+E	5	Red	346-415	432-C6*	2CMA193529R1000

63A, IP44 Splash proof Thermoplastic



Cable entry with compression gland. Cable area 4 - 16mm²

Type	Terminals/Poles	Colour Code	Voltage V	Part No	Product Hierarchy 0000900003 Order Code
2P+E	3	Yellow	100-130	263-C4	2CMA166838R1000
		Blue	200-250	263-C6	2CMA166840R1000
3P+E	4	Black	600-690	363-C5	2CMA166848R1000
		Red	380-415	363-C6*	2CMA166850R1000
		Black	480-500	363-C7*	2CMA166852R1000
		Blue	200-250	363-C9	2CMA166854R1000
3P+N+E	5	Red	346-415	463-C6*	2CMA166862R1000

* Indicates standard product.

Industrial plugs & sockets

Connectors - watertight IP67

16 A, IP67 Watertight Plastic enclosure (PBT)

Cable entry with compression gland. Cable area 1 - 2.5mm²



Type	Terminals/Poles	Colour Code	Voltage V	Part No	Product Hierarchy 0000900003 Order Code
2P+E	3	Yellow	100-130	216-C4W	2CMA166536R1000
		Blue	200-250	216-C6W*	2CMA166538R1000
3P+E	4	Yellow	100-130	316-C4W	2CMA166550R1000
		Black	600-690	316-C5W*	2CMA166552R1000
		Red	380-415	316-C6W*	2CMA166548R1000
		Black	480-500	316-C7W	2CMA166556R1000
		Blue	200-250	316-C9W	2CMA166558R1000
3P+N+E	5	Yellow	100-130	416-C4W	2CMA166570R1000
		Red	346-415	416-C6W*	2CMA166568R1000
		Blue	200-250	416-C9W	2CMA166576R1000

32 A, IP67 Watertight Plastic enclosure (PBT)

Cable entry with compression gland. Cable area 2.5-6 mm²



Type	Terminals/Poles	Colour Code	Voltage V	Part No	Product Hierarchy 0000900003 Order Code
2P+E	3	Yellow	100-130	232-C4W	2CMA166582R1000
		Blue	200-250	232-C6W*	2CMA166584R1000
3P+E	4	Yellow	100-130	332-C4W	2CMA166600R1000
		Black	600-690	332-C5W	2CMA166602R1000
		Red	380-415	332-C6W*	2CMA166598R1000
		Black	480-500	332-C7W	2CMA166606R1000
		Blue	200-250	332-C9W	2CMA166608R1000
3P+N+E	5	Yellow	100-130	432-C4W	2CMA166616R1000
		Red	380-415	432-C6W*	2CMA166618R1000
		Blue	200-250	432-C9W	2CMA166622R1000

63 A, IP67 Watertight Plastic enclosure (PBT)

Cable entry with compression gland, internal and external cable clamp. Cable area 4-16 mm²



Type	Terminals/Poles	Colour Code	Voltage V	Part No	Product Hierarchy 0000900003 Order Code
2P+E	3	Yellow	100-130	263-C4W	2CMA166872R1000
		Blue	200-250	263-C6W	2CMA166874R1000
3P+E	4	Yellow	100-130	363-C4W	2CMA166890R1000
		Black	600-690	363-C5W	2CMA166892R1000
		Red	380-415	363-C6W*	2CMA166894R1000
		Black	480-500	363-C7W	2CMA166896R1000
		Blue	200-250	363-C9W	2CMA166898R1000
3P+N+E	5	Yellow	100-130	463-C4W	2CMA166904R1000
		Red	380-415	463-C6W	2CMA166906R1000
		Blue	200-250	463-C9W	2CMA166910R1000

* Indicates standard product.

Industrial plugs & sockets

Connectors - watertight IP67

125 A, IP67 Watertight
Plastic enclosure (PBT)



Cable entry with compression gland. Internal and external cable clamp. LP types with long phase sleeves and pilot sleeve. Cable area 16-50 mm²



Type	Terminals/Poles	Colour Code	Voltage V	Part No	Product Hierarchy 0000900003 Order Code
2P+E	3	Yellow	100-130	2125-C4W	2CMA166916R1000
		Blue	200-250	2125-C6W	2CMA166918R1000
3P+E	4	Yellow	100-130	3125-C4W	2CMA166922R1000
		Black	600-690	3125-C5W	2CMA166923R1000
		Red	380-415	3125-C6W*	2CMA166924R1000
		Black	480-500	3125-C7W	2CMA166926R1000
		Blue	200-250	3125-C9W	2CMA166928R1000
3P+N+E	5	Yellow	100-130	4125-C4W	2CMA166934R1000
		Red	380-415	4125-C6W*	2CMA166936R1000
		Blue	200-250	4125-C9W	2CMA166940R1000

* Indicates standard product.

Industrial plugs & sockets

Surface sockets - splash proof IP44

16A, IP44 Splash proof Thermoplastic



Flexible membrane and M20 insert for top cable entry.
Rear knockout cable entry. Cable area 1.5 - 4mm²

Type	Terminals/Poles	Colour Code	Voltage V	Part No	Product Hierarchy 0000900003 Order Code
2P+E	3	Yellow	100-130	216-RS4*	2CMA193097R1000
		Blue	200-250	216-RS6*	2CMA193098R1000
3P+E	4	Yellow	100-130	316-RS4	2CMA193104R1000
		Black	600-690	316-RS5	2CMA193105R1000
		Red	380-415	316-RS6*	2CMA193106R1000
		Black	480-500	316-RS7*	2CMA193107R1000
		Blue	200-250	316-RS9	2CMA193108R1000
3P+N+E	5	Red	440-460	316-RS11	2CMA193110R1000
		Red	346-415	416-RS6*	2CMA193115R1000

32A, IP44 Splash proof Thermoplastic



Flexible membrane and M25 insert for top cable entry.
Rear knockout cable entry. Cable area 2.5 - 10mm²

Type	Terminals/Poles	Colour Code	Voltage V	Part No	Product Hierarchy 0000900003 Order Code
2P+E	3	Yellow	100-130	232-RS4	2CMA193121R1000
		Blue	200-250	232-RS6	2CMA193122R1000
3P+E	4	Black	600-690	332-RS5	2CMA193129R1000
		Red	380-415	332-RS6*	2CMA193130R1000
		Black	480-500	332-RS7	2CMA193131R1000
		Blue	200-250	332-RS9	2CMA193132R1000
3P+N+E	5	Red	346-415	432-RS6*	2CMA193139R1000

63A, IP44 Splash proof Thermoplastic Polyester (PBT)



Cable entry M32. Alternative rear knockout cable entry. Cable area 6 - 25mm²

Type	Terminals/Poles	Colour Code	Voltage V	Part No	Product Hierarchy 0000900003 Order Code
2P+E	3	Yellow	100-130	263-RS4	2CMA167474R1000
		Blue	200-250	263-RS6	2CMA167476R1000
3P+E	4	Black	600-690	363-RS5	2CMA167496R1000
		Red	380-415	363-RS6*	2CMA167498R1000
		Black	480-500	363-RS7	2CMA167500R1000
		Blue	200-250	363-RS9	2CMA167502R1000
3P+N+E	5	Red	346-415	463-RS6*	2CMA167484R1000

* Indicates standard product.

Industrial plugs & sockets

Surface sockets - watertight IP67

16 A, IP67 Watertight Plastic enclosure (PBT)

Cable entry Ø 25 mm. Cable area 1.5-4 mm²



Type	Terminals/Poles	Colour Code	Voltage V	Part No	Product Hierarchy 0000900003 Order Code
2P+E	3	Yellow	100-130	216-RS4W	2CMA167148R1000
		Blue	200-250	216-RS6W*	2CMA167149R1000
3P+E	4	Yellow	100-130	316-RS4W	2CMA167155R1000
		Black	600-690	316-RS5W*	2CMA167156R1000
		Red	380-415	316-RS6W*	2CMA167157R1000
		Black	480-500	316-RS7W	2CMA167158R1000
		Blue	200-250	316-RS9W	2CMA167159R1000
3P+N+E	5	Yellow	100-130	416-RS4W	2CMA167165R1000
		Red	346-415	416-RS6W*	2CMA167166R1000
		Blue	200-250	416-RS9W	2CMA167168R1000

32 A, IP67 Watertight Plastic enclosure (PBT)

Cable entry Ø 25 mm. Cable area 2.5-10 mm²



Type	Terminals/Poles	Colour Code	Voltage V	Part No	Product Hierarchy 0000900003 Order Code
2P+E	3	Yellow	100-130	232-RS4W	2CMA167171R1000
		Blue	200-250	232-RS6W*	2CMA167172R1000
3P+E	4	Yellow	100-130	332-RS4W	2CMA167178R1000
		Black	600-690	332-RS5W	2CMA167179R1000
		Red	380-415	332-RS6W*	2CMA167180R1000
		Black	480-500	332-RS7W	2CMA167181R1000
		Blue	200-250	332-RS9W	2CMA167182R1000
3P+N+E	5	Yellow	100-130	462-RS4W	2CMA167188R1000
		Red	380-415	462-RS6W	2CMA167187R1000
		Blue	200-250	462-RS9W	2CMA167191R1000

63 A, IP67 Watertight Plastic enclosure (PBT)

Cable entry with compression gland, internal and external cable clamp. Cable area 4-16 mm²



Type	Terminals/Poles	Colour Code	Voltage V	Part No	Product Hierarchy 0000900003 Order Code
2P+E	3	Yellow	100-130	263-RS4W	2CMA167304R1000
		Blue	200-250	263-RS6W	2CMA167306R1000
3P+E	4	Yellow	100-130	363-RS4W	2CMA167312R1000
		Black	600-690	363-RS5W	2CMA167314R1000
		Red	380-415	363-RS6W*	2CMA167316R1000
		Black	480-500	363-RS7W	2CMA167318R1000
		Blue	200-250	363-RS9W	2CMA167320R1000
3P+N+E	5	Yellow	100-130	463-RS4W	2CMA167326R1000
		Red	380-415	463-RS6W	2CMA167328R1000
		Blue	200-250	463-RS9W	2CMA167332R1000

* Indicates standard product.

Industrial plugs & sockets

Surface sockets - watertight IP67

125 A, IP67 Watertight
Plastic enclosure (PBT)



Cable entry Ø 50 mm. Cable area 16-70 mm²

Type	Terminals/Poles	Colour Code	Voltage V	Part No	Product Hierarchy 0000900003 Order Code
2P+E	3	Yellow	100-130	2125-RS4W	2CMA167244R1000
		Blue	200-250	2125-RS6W	2CMA167246R1000
3P+E	4	Yellow	100-130	3125-RS4W	2CMA167250R1000
		Black	600-690	3125-RS5W	2CMA167251R1000
		Red	380-415	3125-RS6W*	2CMA167252R1000
		Black	480-500	3125-RS7W	2CMA167254R1000
		Blue	200-250	3125-RS9W	2CMA167256R1000
3P+N+E	5	Yellow	100-130	4125-RS4W	2CMA167262R1000
		Red	380-415	4125-RS6W*	2CMA167264R1000
		Blue	200-250	4125-RS9W	2CMA167268R1000

* Indicates standard product.

Industrial plugs & sockets

Surface inlets - splash proof IP44

16A, IP44 Splash proof Thermoplastic (PA)



Flexible membrane and metric threaded M20 insert
for top cable entry. Rear knock-out cable entry. Cable area 1.5-4 mm²

Type	Terminals/Poles	Colour Code	Voltage V	Part No	Product Hierarchy 0000900003 Order Code
2P+E	3	Yellow	100-130	216-BS4	2CMA193289R1000
		Blue	200-250	216-BS6	2CMA193290R1000
3P+E	4	Yellow	100-130	316-BS4	2CMA193296R1000
		Black	600-690	316-BS5	2CMA193297R1000
		Red	380-415	316-BS6	2CMA193298R1000
		Black	480-500	316-BS7	2CMA193299R1000
3P+N+E	5	Blue	200-250	316-BS9	2CMA193300R1000
		Red	346-415	416-BS6	2CMA193307R1000

32A, IP44 Splash proof Thermoplastic (PA)



Flexible membrane and metric threaded M25 insert
for top cable entry. Rear knock-out cable entry. Cable area 2.5-10 mm²

Type	Terminals/Poles	Colour Code	Voltage V	Part No	Product Hierarchy 0000900003 Order Code
2P+E	3	Yellow	100-130	232-BS4	2CMA193313R1000
		Blue	200-250	232-BS6	2CMA193314R1000
		Black	600-690	332-BS5	2CMA193321R1000
		Red	380-415	332-BS6	2CMA193322R1000
		Black	480-500	332-BS7	2CMA193323R1000
		Blue	200-250	332-BS9	2CMA193324R1000
3P+N+E	5	Red	346-415	432-BS6	2CMA193331R1000

63A, IP44 Splash proof Thermoplastic Polyester (PBT)



M32 alternative rear knock-out cable entry. Cable area 6-25 mm²

Type	Terminals/Poles	Colour Code	Voltage V	Part No	Product Hierarchy 0000900003 Order Code
2P+E	3	Yellow	100-130	263-BS4	2CMA167542R1000
		Blue	200-250	263-BS6	2CMA167544R1000
		Black	600-690	363-BS5	2CMA167552R1000
		Red	380-415	363-BS6	2CMA167554R1000
		Black	480-500	363-BS7	2CMA167556R1000
		Blue	200-250	363-BS9	2CMA167558R1000
3P+N+E	5	Red	346-415	463-BS6	2CMA167566R1000

* Indicates standard product.

Industrial plugs & sockets

Surface inlets - watertight IP67

16 A, IP67 Watertight Plastic enclosure (PBT)



Cable entry Ø 25 mm. Cable area 1.5-4 mm²

Type	Terminals/Poles	Colour Code	Voltage V	Part No	Product Hierarchy 0000900003 Order Code
2P+E	3	Yellow	100-130	216-BS4W	2CMA167042R1000
		Blue	200-250	216-BS6W*	2CMA167044R1000
3P+E	4	Yellow	100-130	316-BS4W	2CMA167056R1000
		Black	600-690	316-BS5W*	2CMA167058R1000
		Red	380-415	316-BS6W*	2CMA167068R1000
		Black	480-500	316-BS7W	2CMA167062R1000
		Blue	200-250	316-BS9W	2CMA167064R1000
3P+N+E	5	Yellow	100-130	416-BS4W	2CMA167076R1000
		Red	346-415	416-BS6W	2CMA167078R1000
		Blue	200-250	416-BS9W	2CMA167082R1000

32 A, IP67 Watertight Plastic enclosure (PBT)



Cable entry Ø 25 mm. Cable area 2.5-10 mm²

Type	Terminals/Poles	Colour Code	Voltage V	Part No	Product Hierarchy 0000900003 Order Code
2P+E	3	Yellow	100-130	232-BS4W	2CMA167088R1000
		Blue	200-250	232-BS6W*	2CMA167090R1000
3P+E	4	Yellow	100-130	332-BS4W	2CMA167102R1000
		Black	600-690	332-BS5W	2CMA167103R1000
		Red	380-415	332-BS6W*	2CMA167104R1000
		Black	480-500	332-BS7W	2CMA167106R1000
		Blue	200-250	332-BS9W	2CMA167108R1000
3P+N+E	5	Yellow	100-130	462-BS4W	2CMA167118R1000
		Red	346-415	462-BS6W*	2CMA167122R1000
		Blue	200-250	462-BS9W	2CMA167126R1000

63 A, IP67 Watertight Plastic enclosure (PBT)



Cable entry Ø 32 mm. Cable area 6-25 mm²

Type	Terminals/Poles	Colour Code	Voltage V	Part No	Product Hierarchy 0000900003 Order Code
2P+E	3	Yellow	100-130	263-BS4W	2CMA167338R1000
		Blue	200-250	263-BS6W	2CMA167340R1000
3P+E	4	Yellow	100-130	363-BS4W	2CMA167346R1000
		Black	600-690	363-BS5W	2CMA167348R1000
		Red	380-415	363-BS6W*	2CMA167356R1000
		Black	480-500	363-BS7W	2CMA167352R1000
		Blue	200-250	363-BS9W	2CMA167354R1000
3P+N+E	5	Yellow	100-130	463-BS4W	2CMA167360R1000
		Red	346-415	463-BS6W	2CMA167362R1000
		Blue	200-250	463-BS9W	2CMA167366R1000

* Indicates standard product.

Industrial plugs & sockets

Surface inlets - watertight IP67

125 A, IP67 Watertight
Plastic enclosure (PBT) 



Cable entry \varnothing 50 mm. Cable area 16-70 mm²

Type	Terminals/Poles	Colour Code	Voltage V	Part No	Product Hierarchy 0000900003 Order Code
2P+E	3	Yellow	100-130	2125-BS4W	2CMA167274R1000
		Blue	200-250	2125-BS6W	2CMA167276R1000
3P+E	4	Yellow	100-130	3125-BS4W	2CMA167280R1000
		Black	480-500	3125-BS7W	2CMA167284R1000
		Blue	200-250	3125-BS9W	2CMA167286R1000
		Red	380-415	3125-BS6W	2CMA167282R1000
3P+N+E	5	Yellow	100-130	4125-BS4W	2CMA167292R1000
		Blue	200-250	4125-BS9W	2CMA167298R1000
		Red	346-415	4125-BS6W*	2CMA167294R1000

* Indicates standard product.

Industrial plugs & sockets

Panel mounted socket outlets - splash proof IP44

16A, IP44 Splash proof Thermoplastic (PA)



Cable area 1.5-4 mm²



Type	Terminals/Poles	Colour Code	Voltage V	Part No	Product Hierarchy 0000900003 Order Code
2P+E	3	Yellow	100-130	216-RU4	2CMA193169R1000
		Blue	200-250	216-RU6*	2CMA193170R1000
3P+E	4	Yellow	100-130	316-RU4	2CMA193176R1000
		Black	600-690	316-RU5	2CMA193177R1000
		Red	380-415	316-RU6*	2CMA193178R1000
		Black	480-500	316-RU7	2CMA193179R1000
		Blue	200-250	316-RU9*	2CMA193180R1000
		Red	440-460	316-RU11	2CMA193182R1000
3P+E+N	5	Red	440-460	316-RU6*	2CMA193187R1000

32A, IP44 Splash proof Thermoplastic (PA)



Cable area 2.5-10 mm²



Type	Terminals/Poles	Colour Code	Voltage V	Part No	Product Hierarchy 0000900003 Order Code
2P+E	3	Yellow	100-130	232-RU4*	2CMA193241R1000
		Blue	200-250	232-RU6*	2CMA193242R1000
3P+E	4	Black	600-690	332-RU5	2CMA193249R1000
		Red	380-415	332-RU6*	2CMA193250R1000
		Black	480-500	332-RU7	2CMA193251R1000
		Blue	200-250	332-RU9*	2CMA193252R1000
3P+N+E	5	Red	346-415	463-RU6*	2CMA193259R1000

63A, IP44 Splash proof Thermoplastic Polyester (PBT)



Cable area 6-25 mm²



Type	Terminals/Poles	Colour Code	Voltage V	Part No	Product Hierarchy 0000900003 Order Code
2P+E	3	Yellow	100-130	263-RU4	2CMA167508R1000
		Blue	200-250	263-RU6	2CMA167510R1000
3P+E	4	Black	600-690	363-RU5	2CMA167518R1000
		Red	380-415	363-RU6	2CMA167520R1000
		Black	480-500	363-RU7	2CMA167522R1000
		Blue	200-250	363-RU9	2CMA167524R1000
3P+N+E	5	Red	346-415	463-RU6*	2CMA167532R1000

* Indicates standard product.

Industrial plugs & sockets

Panel mounted socket outlets - watertight IP67

16A, IP67 Watertight Thermoplastic (PA)



Cable area 1.5-4 mm²



Type	Terminals/Poles	Colour Code	Voltage V	Part No	Product Hierarchy 0000900003 Order Code
2P+E	3	Yellow	100-130	216-RAU4*	2CMA166994R1000
		Blue	200-250	216-RAU6*	2CMA166996R1000
3P+E	4	Yellow	100-130	316-RAU4W	2CMA167008R1000
		Black	600-690	316-RAU5W	2CMA167010R1000
		Red	380-415	316-RAU6W*	2CMA167012R1000
		Black	480-500	316-RAU7W	2CMA167014R1000
		Blue	200-250	316-RAU9W	2CMA167016R1000
		Red	440-460	316-RAU11W	2CMA167020R1000
3P+E+N	5	Red	440-460	316-RAU6W*	2CMA167360R1000

32A, IP67 Watertight Thermoplastic (PA)



Cable area 2.5-10 mm²



Type	Terminals/Poles	Colour Code	Voltage V	Part No	Product Hierarchy 0000900003 Order Code
2P+E	3	Yellow	100-130	232-RAU4*	2CMA166946R1000
		Blue	200-250	232-RAU6*	2CMA166948R1000
3P+E	4	Black	600-690	332-RAU5	2CMA166962R1000
		Red	380-415	332-RAU6*	2CMA166964R1000
		Black	480-500	332-RAU7	2CMA166966R1000
		Blue	200-250	332-RAU9	2CMA166968R1000
3P+N+E	5	Red	346-415	432-RAU6*	2CMA166982R1000

63A, IP67 Watertight Thermoplastic Polyester (PBT)



Cable area 6-25 mm²



Type	Terminals/Poles	Colour Code	Voltage V	Part No	Product Hierarchy 0000900003 Order Code
2P+E	3	Yellow	100-130	263-RAU4	2CMA167440R1000
		Blue	200-250	263-RAU6	2CMA167442R1000
3P+E	4	Black	600-690	363-RAU5	2CMA167450R1000
		Red	380-415	363-RAU6	2CMA167452R1000
		Black	480-500	363-RAU7	2CMA167454R1000
		Blue	200-250	363-RAU9	2CMA167456R1000
3P+N+E	5	Red	346-415	463-RAU6*	2CMA167470R1000

* Indicates standard product.

Industrial plugs & sockets

Switched interlocked sockets - splash proof IP44

16A, IP44 Splash proof Plastic enclosure (PBT)



Cable entry with knock-outs Ø 25 mm. Cable area 1.5-4 mm²

Type	Terminals/Poles	Colour Code	Voltage V	Part No	Product Hierarchy 000900003 Order Code
2P+E	3	Yellow	100-130	216-MVS4	2CMA167645R1000
		Blue	200-250	216-MVS6*	2CMA167646R1000
3P+E	4	Yellow	100-130	316-MVS4	2CMA167652R1000
		Black	600-690	316-MVS5	2CMA167653R1000
		Red	380-415	316-MVS6*	2CMA167654R1000
		Black	480-500	316-MVS7	2CMA167655R1000
		Blue	200-250	316-MVS9	2CMA167656R1000
		Red	440-460	316-MVS11	2CMA167658R1000
3P+E+N	5	Red	440-460	316-MVS6*	2CMA167663R1000



32A, IP44 Splash proof Plastic enclosure (PBT)



Cable entry with knock-outs Ø 25 mm. Cable area 2.5-10 mm²

Type	Terminals/Poles	Colour Code	Voltage V	Part No	Product Hierarchy 000900003 Order Code
2P+E	3	Yellow	100-130	232-MVS4	2CMA167691R1000
		Blue	200-250	232-MVS6	2CMA167692R1000
3P+E	4	Black	600-690	332-MVS5	2CMA167699R1000
		Red	380-415	332-MVS6	2CMA167700R1000
		Black	480-500	332-MVS7	2CMA167701R1000
		Blue	200-250	332-MVS9	2CMA167702R1000
3P+N+E	5	Red	346-415	432-MVS6*	2CMA167091R1000



Industrial plugs & sockets

Switched interlocked sockets - watertight IP67

16A, IP67 Watertight Plastic enclosure (PBT)



Cable entry with knock-outs Ø 25 mm. Cable area 1.5-4 mm²



Type	Terminals/Poles	Colour Code	Voltage V	Part No	Product Hierarchy 0000900003 Order Code
2P+E	3	Yellow	100-130	216-MVS4W	2CMA167823R1000
		Blue	200-250	216-MVS6W*	2CMA167824R1000
3P+E	4	Yellow	100-130	316-MVS4W	2CMA167830R1000
		Black	600-690	316-MVS5W	2CMA167831R1000
		Red	380-415	316-MVS6W*	2CMA167832R1000
		Black	480-500	316-MVS7W	2CMA167833R1000
		Blue	200-250	316-MVS9W	2CMA167834R1000
		Red	440-460	316-MVS11W	2CMA167836R1000
3P+E+N	5	Red	440-460	316-MVS6W*	2CMA167842R1000

32A, IP67 Watertight Plastic enclosure (PBT)



Cable entry with knock-outs Ø 25 mm. Cable area 2.5-10 mm²



Type	Terminals/Poles	Colour Code	Voltage V	Part No	Product Hierarchy 0000900003 Order Code
2P+E	3	Yellow	100-130	232-MVS4W	2CMA167870R1000
		Blue	200-250	232-MVS6W	2CMA167871R1000
3P+E	4	Black	600-690	332-MVS5W	2CMA167877R1000
		Red	380-415	332-MVS6W	2CMA167878R1000
		Black	480-500	332-MVS7W	2CMA167880R1000
		Blue	200-250	332-MVS9W	2CMA167881R1000
3P+N+E	5	Red	346-415	432-MVS6W	2CMA167888R1000

Industrial plugs & sockets

Switched interlocked socket outlets - watertight IP67

16 A, IP67 Watertight Thermoplastic Polyester (PBT)



Cable entry with knock-outs Ø 25 mm up/M25 down. Cable area 1.5-4 mm²



Type	Terminals/Poles	Colour Code	Voltage V	Part No	Product Hierarchy 0000900003 Order Code
2P+E	3	Yellow	100-130	216-MHS4W	2CMA167800R1000
		Blue	200-250	216-MHS6W*	2CMA167801R1000
3P+E	4	Yellow	100-130	316-MHS4W	2CMA167807R1000
		Black	600-690	316MHS5W	2CMA167808R1000
		Red	380-415	316-MHS6W*	2CMA167809R1000
		Black	480-500	316MHS7W	2CMA167810R1000
		Blue	200-250	316-MHS9W	2CMA167811R1000
		Red	440-460	316-MHS11W	2CMA167813R1000
		Yellow	100-130	416-MHS4W	2CMA167817R1000
3P+N +E	5	Red	380-415	416-MHS6W*	2CMA167818R1000
		Black	480-500	416MHS7W	2CMA167819R1000
		Blue	200-250	416-MHS9W	2CMA167820R1000
		Red	440-460	416-MHS11W	2CMA167821R1000

32 A, IP67 Watertight Thermoplastic Polyester (PBT)



Cable entry with knock-outs Ø 25 mm up/M25 down. Cable area 2.5-10 mm²



Type	Terminals/Poles	Colour Code	Voltage V	Part No	Product Hierarchy 0000900003 Order Code
2P+E	3	Yellow	100-130	232-MHS4W	2CMA167847R1000
		Blue	200-250	232-MHS6W	2CMA167848R1000
3P+E	4	Yellow	100-130	332-MHS4W	2CMA167854R1000
		Black	600-690	332MHS5W	2CMA167855R1000
		Red	380-440	332-MHS3W	2CMA167853R1000
		Black	480-500	332MHS7W	2CMA167857R1000
		Blue	200-250	332-MHS9W	2CMA167858R1000
		Red	440-460	332-MHS11W	2CMA167860R1000
		Yellow	100-130	432-MHS4W	2CMA167864R1000
3P+N +E	5	Red	380-440	432-MHS3W	2CMA167863R1000
		Black	480-500	432MHS7W	2CMA167866R1000
		Blue	200-250	432-MHS9W	2CMA167867R1000
		Red	440-460	432-MHS11W	2CMA167868R1000

63A, IP67 Watertight Thermoplastic Polyester (PBT)



Cable entry with knock-outs 2xØ 32 mm. Cable area 6-25 mm²



Type	Terminals/Poles	Colour Code	Voltage V	Part No	Product Hierarchy 0000900003 Order Code
2P+E	3	Yellow	100-130	263-MHS4W	2CMA167893R1000
		Blue	200-250	263-MHS6W	2CMA167894R1000
3P+E	4	Yellow	100-130	363-MHS4W	2CMA167897R1000
		Black	600-690	363MHS5W	2CMA167898R1000
		Red	380-415	363-MHS6W	2CMA167899R1000
		Black	480-500	363MHS7W	2CMA167900R1000
		Blue	200-250	363-MHS9W	2CMA167901R1000
		Red	440-460	363-MHS11W	2CMA167902R1000
		Yellow	100-130	463-MHS4W	2CMA167904R1000
3P+N +E	5	Red	380-415	463-MHS6W*	2CMA167905R1000
		Black	480-500	463MHS7W	2CMA167906R1000
		Blue	200-250	463-MHS9W	2CMA167907R1000
		Red	440-460	463-MHS11W	2CMA167908R1000

* Indicates standard product.

Industrial plugs & sockets

Switched interlocked socket outlets with protection - splash proof IP44



16 A, IP44 Splash proof
Thermoplastic Polyester (PBT)



Contains RCD 25 A/0.03 A, type A. Cable entry with knock-outs 2xØ 25 mm. Cable area 1.5-4 mm²

Type	Terminals/Poles	Colour Code	Voltage V	Part No	Product Hierarchy Order Code
2P+E	3	Blue	200-250	216-MPR6	2CMA167756R1000
3P+E	4	Red	380-415	316-MPR6	2CMA167764R1000
		Blue	200-250	316-MPR9	2CMA167766R1000
3P+N+E	5	Red	346-415	416-MPR6	2CMA167772R1000



32 A, IP44 Splash proof
Thermoplastic Polyester (PBT)



Contains RCD 40 A/0.03 A, type A. Cable entry with knock-outs 2xØ 25 mm. Cable area 2.5-10 mm²

Type	Terminals/Poles	Colour Code	Voltage V	Part No	Product Hierarchy Order Code
2P+E	3	Blue	200-250	232-MPR6	2CMA167778R1000
3P+E	4	Red	380-415	332-MPR6	2CMA167786R1000
		Blue	200-250	332-MPR9	2CMA167788R1000
3P+N+E	5	Red	346-415	432-MPR6	2CMA167795R1000

Industrial plugs & sockets

Switched interlocked socket outlets with protection - watertight IP67



16 A, IP67 Watertight
Thermoplastic Polyester (PBT)



Contains RCD 25 A/0.03 A, type A. Cable entry with knock-outs 2xØ 25 mm. Cable area 1.5-4 mm²

Type	Terminals/Poles	Colour Code	Voltage V	Part No	Product Hierarchy Order Code
2P+E	3	Blue	200-250	216-MPR6W	2CMA168058R1000
3P+E	4	Red	380-415	316-MPR6W	2CMA168066R1000
		Blue	200-250	316-MPR9W	2CMA168068R1000
3P+N+E	5	Red	346-415	416-MPR6W	2CMA168075R1000



32 A, IP67 Watertight
Thermoplastic Polyester (PBT)



Contains RCD 40 A/0.03 A, type A. Cable entry with knock-outs 2xØ 25 mm. Cable area 2.5-10 mm²

Type	Terminals/Poles	Colour Code	Voltage V	Part No	Product Hierarchy Order Code
2P+E	3	Blue	200-250	232-MPR6W	2CMA168081R1000
3P+E	4	Red	380-415	332-MPR6W	2CMA168089R1000
		Blue	200-250	332-MPR9W	2CMA168091R1000
3P+N+E	5	Red	346-415	432-MPR6W	2CMA168098R1000

Industrial plugs & sockets

For entertainment



With extensive experience of designing and producing industrial plugs and sockets, ABB provides products of high quality, functionality, reliability and safety. Regardless of the application, safety of people is the highest priority in electrical installations.

ABB is introducing a new series of black plugs and sockets in plastic enclosure (PA), which are very well suited for entertainment applications, such as concerts, cinemas, radio and television studios, and open air events.

The black plugs and sockets are perfect for both indoor and outdoor use, where they will blend into their dark surroundings. Pin and sleeve configuration according to IEC standard.

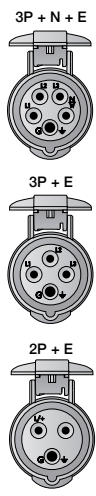
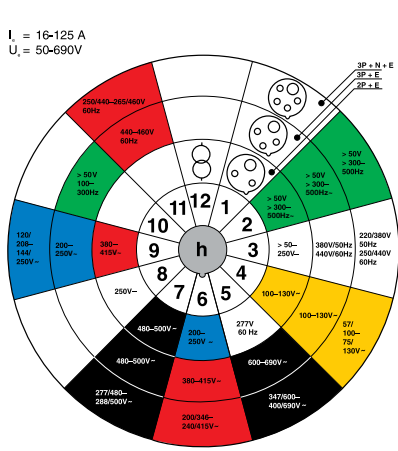

Industrial plugs & sockets

For entertainment

16 A and 32 A, IP44 Splash proof Plastic enclosure (PA)

Cable entry with compression gland.
Cable area 1-2.5 mm² for 16 A and 2.5-6 mm² for 32 A.



216-P6B



216-C6B



216-RAM6B

Type	Rating A	Terminals/Poles	Voltage V	Colour Code	Part No	Product Hierarchy 0000900003 Order Code
Plug						
2P+E	16	3	200-250	Black	216-P6B	2CMA100549R1000
3P+E		4	380-415		316-P6B	2CMA100550R1000
3P+E+N		5	346-415		416-P6B	2CMA100551R1000
2P+E	32	3	200-250		232-P6B	2CMA100552R1000
3P+E		4	380-415		332-P6B	2CMA100553R1000
3P+E+N		5	346-415		432-P6B	2CMA100554R1000
Connector						
2P+E	16	3	200-250	Black	216-C6B	2CMA100561R1000
3P+E		4	380-415		316-C6B	2CMA100562R1000
3P+E+N		5	346-415		416-C6B	2CMA100563R1000
2P+E	32	3	200-250		232-C6B	2CMA100564R1000
3P+E		4	380-415		332-C6B	2CMA100565R1000
3P+E+N		5	346-415		432-C6B	2CMA100566R1000
Socket outlet						
2P+E	16	3	200-250	Black	216-RAM6B	2CMA100543R1000
3P+E		4	380-415		316-RAM6B	2CMA100544R1000
3P+E+N		5	346-415		416-RAM6B	2CMA100545R1000
2P+E	32	3	200-250		232-RAM6B	2CMA100546R1000
3P+E		4	380-415		332-RAM6B	2CMA100547R1000
3P+E+N		5	346-415		432-RAM6B	2CMA100548R1000

Industrial plugs & sockets

For entertainment

Kombi Modules, IP44 Splash proof Plastic enclosure



MP16/1



MP32/1



MPR16



Type	CEE17 Sockets	13A BS Sockets	Circuit Breaker Protection	Voltage V	Enclosure Colour	Part No	Product Hierarchy 0000900003 Order Code
------	---------------	----------------	----------------------------	-----------	------------------	---------	---

Kombi with MCB protection

3P+E+N	1 x 16A	2 x 13A	S201-C13 - S203-C16	240-415	Black	MP16/1	2CMA101658R1000
	1 x 32A	2 x 13A	S201-C13 - S203-C32			MP32	2CMA101656R1000
	2 x 32A	1 x 13A	S201-C13 - 2 x S203-C32			MP32/1	2CMA101657R1000
3P+E+N	1 x 16A	2 x 13A	S201-C13 - S203-C16	240-415	Grey	MPG16/1	2CMA101654R1000
	1 x 32A	2 x 13A	S201-C13 - S203-C32			MPG32	2CMA101652R1000
	2 x 32A	1 x 13A	S201-C13 - 2 x S203-C32			MPG32/1	2CMA101653R1000

Kombi with MCB & RCD protection

3P+E+N	1 x 16A	2 x 13A	S201-C13 - S203-C16 RCD F204 A-25/0,03	240-415	Black	MPR16	2CMA101655R1000
3P+E+N	1 x 16A	2 x 13A	S201-C13 - S203-C16 RCD F204 A-25/0,03	240-415	Grey	MPRG16/1	2CMA101651R1000

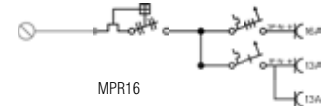
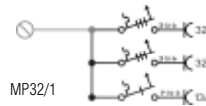
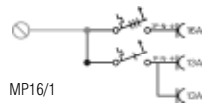

Empty Kombi enclosures

Empty Kombi enclosures	Enclosure Colour	Product Hierarchy 0000900003 Order Code
One row with DIN-rail for 13 modules and one row for three IEC outlets 16-32A	Black	2CMA101660R1000
	Grey	2CMA101659R1000

Kombi enclosure dimensions

	Hmm	Wmm	Dmm
MP16/1, MPG16/1, MPR16, MPRG16	358	250	150
MP32, MP32/1, MP32G, MPG32/1	358	250	160
Empty enclosures black and grey	358	250	124

Contact us

ABB Ltd

Tower Court
Foleshill Enterprise Park
Courtaulds Way
Coventry CV6 5NX

Tel: 0333 999 9900

Fax: 0333 999 9901

Email: LV.Enquiries@gb.abb.com

Twitter: @ABBUKLP

www.abb.co.uk/lowvoltage

Note: We reserve the right to make technical changes or modify the contents of this document without prior notice. With regard to purchase orders, the agreed particulars shall prevail. ABB Ltd does not accept any responsibility whatsoever for potential errors or possible lack of information in this document.

We reserve all rights in this document and in the subject matter and illustrations contained therein. Any reproduction, disclosure to third parties or utilization of its contents – in whole or in parts – is forbidden without prior written consent of ABB Ltd.

Copyright © 2015 ABB Ltd
All rights reserved