

# Optocoupler, Photodarlington Output, AC Input, High Gain (Single, Dual Channel)

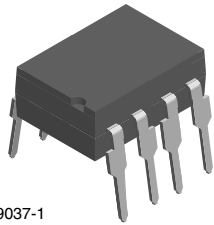

i179037-1

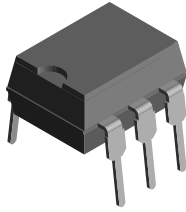
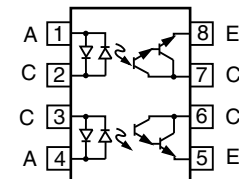
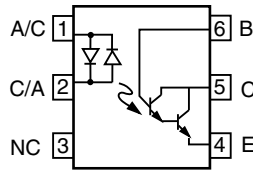

## FEATURES

- AC or polarity insensitive inputs
- Built-in reverse polarity input protection
- Industry standard DIP package
- Compliant to RoHS Directive 2002/95/EC and in accordance to WEEE 2002/96/EC



RoHS COMPLIANT

## APPLICATIONS

- Designed for applications requiring detection or monitoring of AC signals

## AGENCY APPROVALS

- UL1577, file no. E52744 system code H, double protection
- CSA 93751
- BSI IEC 60950; IEC 60065
- DIN EN 60747-5-2 (VDE 0884)/DIN EN 60747-5-5 (pending), available with option 1
- CQC

## DESCRIPTION

The IL755, ILD755 are bidirectional input optically coupled isolators. They consist of two gallium arsenide infrared emitting diodes coupled to a silicon NPN photodarlington per channel.

The IL755 is single channel Darlington optocoupler. The ILD755 has two isolated channels in a single DIP package.

ORDERING INFORMATION				
<div style="display: flex; justify-content: space-around; align-items: center;"> <div style="border: 1px solid black; padding: 2px;">I</div> <div style="border: 1px solid black; padding: 2px;">L</div> <div style="border: 1px solid black; padding: 2px;">x</div> <div style="border: 1px solid black; padding: 2px;">7</div> <div style="border: 1px solid black; padding: 2px;">5</div> <div style="border: 1px solid black; padding: 2px;">5</div> <div style="border: 1px solid black; padding: 2px;">-</div> <div style="border: 1px solid black; padding: 2px;">#</div> <div style="border: 1px solid black; padding: 2px;">X</div> <div style="border: 1px solid black; padding: 2px;">0</div> <div style="border: 1px solid black; padding: 2px;">#</div> <div style="border: 1px solid black; padding: 2px;">#</div> <div style="border: 1px solid black; padding: 2px;">T</div> </div> <p style="text-align: center;"> <span style="margin-right: 100px;">PART NUMBER</span> <span style="margin-right: 100px;">CTR BIN</span> <span style="margin-right: 100px;">PACKAGE OPTION</span> <span style="margin-right: 100px;">TAPE AND REEL</span> </p>				
AGENCY CERTIFIED/PACKAGE	CTR (%)			
	SINGLE CHANNEL, 6 PIN		DUAL CHANNEL, 8 PIN	
	± 2 mA	± 1 mA	± 2 mA	± 1 mA
UL, CSA, BSI, CQC	≥ 750	≥ 1000	≥ 750	≥ 1000
DIP-#	IL755-1	IL755-2	ILD755-1	ILD755-2
SMD-#, option 7	IL755-1X007T <sup>(1)</sup>	IL755-2X007T	-	ILD755-2X007T
VDE, UL, CSA, BSI, CQC	≥ 750	≥ 1000	≥ 750	≥ 1000
DIP-#	IL755-1X001	-	-	-
SMD-#, option 7	-	-	ILD755-1X017	-

### Notes

- Additional options may be possible, please contact sales office.
- <sup>(1)</sup> Also available in tubes; do not add "T" to end.



ABSOLUTE MAXIMUM RATINGS (T <sub>amb</sub> = 25 °C, unless otherwise specified)					
PARAMETER	TEST CONDITION	PART	SYMBOL	VALUE	UNIT
<b>INPUT</b>					
Forward continuous current			I <sub>F</sub>	60	mA
Power dissipation			P <sub>diss</sub>	100	mW
Derate linearly from 25°C				1.33	mW/°C
<b>OUTPUT</b>					
Collector emitter breakdown voltage			BV <sub>CEO</sub>	60	V
Collector base breakdown voltage			BV <sub>CBO</sub>	60	V
Power dissipation		IL755-1	P <sub>diss</sub>	200	mW
		IL755-2		200	mW
		ILD755-1		150	mW
		ILD755-2		150	mW
Derate linearly from 25°C		IL755-1		2.6	mW/°C
		IL755-2		2.6	mW/°C
		ILD755-1		2.0	mW/°C
		ILD755-2		2.0	mW/°C
<b>COUPLER</b>					
Isolation test voltage between emitter and detector	t = 1 s		V <sub>ISO</sub>	7500/5300	V <sub>AC peak</sub> /V <sub>RMS</sub>
Creepage distance				≥ 7	mm
Clearance distance				≥ 7	mm
Total power dissipation		IL755-1	P <sub>tot</sub>	250	mW
		IL755-2		250	mW
		ILD755-1		400	mW
		ILD755-2		400	mW
Derate linearly from 25 °C		IL755-1		3.0	mW/°C
		IL755-2		3.0	mW/°C
		ILD755-1		3.0	mW/°C
		ILD755-2		3.0	mW/°C
Storage temperature			T <sub>stg</sub>	- 55 to + 150	°C
Operating temperature			T <sub>amb</sub>	- 55 to + 100	°C
Lead soldering time at 260 °C				10	s

**Note**

- Stresses in excess of the absolute maximum ratings can cause permanent damage to the device. Functional operation of the device is not implied at these or any other conditions in excess of those given in the operational sections of this document. Exposure to absolute maximum ratings for extended periods of the time can adversely affect reliability.

ELECTRICAL CHARACTERISTICS (T <sub>amb</sub> = 25 °C, unless otherwise specified)						
PARAMETER	TEST CONDITION	SYMBOL	MIN.	TYP.	MAX.	UNIT
<b>INPUT</b>						
Forward voltage	I <sub>F</sub> = ± 10 mA	V <sub>F</sub>		1.2	1.5	V
<b>OUTPUT</b>						
Collector emitter breakdown voltage	I <sub>C</sub> = 1.0 mA	BV <sub>CEO</sub>	60	75		V
Collector base breakdown voltage	I <sub>C</sub> = 10 μA	BV <sub>CBO</sub>	60	90		V
Collector emitter leakage current	V <sub>CE</sub> = 10 V, I <sub>F</sub> = 0 A	I <sub>CEO</sub>		10	100	nA
<b>COUPLER</b>						
Collector emitter saturation voltage	I <sub>C</sub> = 10 mA, I <sub>F</sub> = ± 10 mA	V <sub>CEsat</sub>			1	V

**Note**

- Minimum and maximum values are testing requirements. Typical values are characteristics of the device and are the result of engineering evaluation. Typical values are for information only and are not part of the testing requirements.

<b>CURRENT TRANSFER RATIO</b> ( $T_{amb} = 25\text{ }^{\circ}\text{C}$ , unless otherwise specified)							
PARAMETER	TEST CONDITION	PART	SYMBOL	MIN.	TYP.	MAX.	UNIT
Current transfer ratio	$I_F = \pm 2\text{ mA}$ , $V_{CE} = 5.0\text{ V}$	IL755-1	CTR	750			%
	$I_F = \pm 2\text{ mA}$ , $V_{CE} = 5.0\text{ V}$	ILD755-1	CTR	750			%
	$I_F = \pm 1\text{ mA}$ , $V_{CE} = 5.0\text{ V}$	IL755-2	CTR	1000			%
	$I_F = \pm 1\text{ mA}$ , $V_{CE} = 5.0\text{ V}$	ILD755-2	CTR	1000			%

<b>SWITCHING CHARACTERISTICS</b> ( $T_{amb} = 25\text{ }^{\circ}\text{C}$ , unless otherwise specified)							
PARAMETER	TEST CONDITION	PART	SYMBOL	MIN.	TYP.	MAX.	UNIT
Rise time	$V_{CC} = 10\text{ V}$ , $I_F = \pm 2\text{ mA}$ , $R_L = 100\text{ }\Omega$	IL755-1	$t_r$		50		$\mu\text{s}$
		ILD755-1	$t_r$		50		$\mu\text{s}$
Fall time	$V_{CC} = 10\text{ V}$ , $I_F = \pm 2\text{ mA}$ , $R_L = 100\text{ }\Omega$	IL755-1	$t_f$		50		$\mu\text{s}$
		ILD755-1	$t_f$		50		$\mu\text{s}$
Rise time	$V_{CC} = 10\text{ V}$ , $I_F = \pm 1\text{ mA}$ , $R_L = 100\text{ }\Omega$	IL755-2	$t_r$		70		$\mu\text{s}$
		ILD755-2	$t_r$		70		$\mu\text{s}$
Fall time	$V_{CC} = 10\text{ V}$ , $I_F = \pm 1\text{ mA}$ , $R_L = 100\text{ }\Omega$	IL755-2	$t_f$		70		$\mu\text{s}$
		ILD755-2	$t_f$		70		$\mu\text{s}$

**TYPICAL CHARACTERISTICS** ( $T_{amb} = 25\text{ }^{\circ}\text{C}$ , unless otherwise specified)

Fig. 1 - LED Forward Current vs. Forward Voltage

 Fig. 3 - Normalized Non-Saturated and Saturated  $CTR_{CE}$  vs. LED Current

 Fig. 2 - Normalized Non-Saturated and Saturated  $CTR_{CE}$  vs. LED Current

 Fig. 4 - Normalized Non-Saturated and Saturated  $I_{CE}$  vs. LED Current

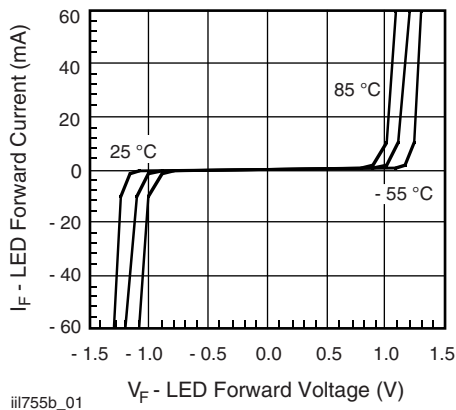
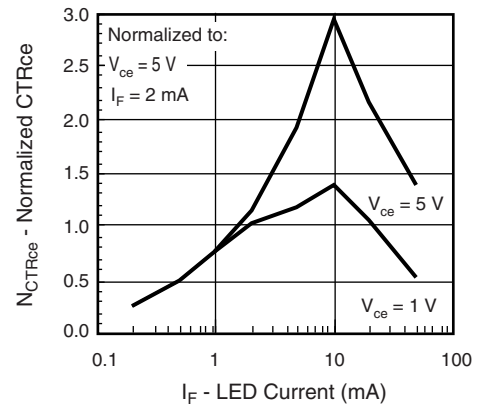
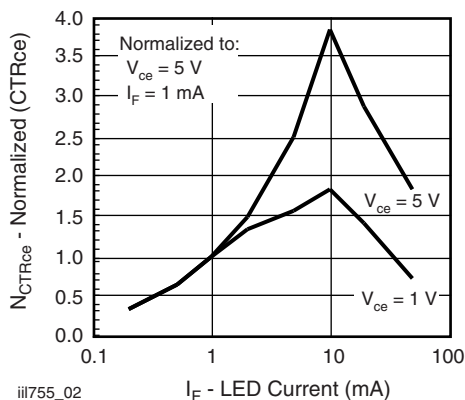
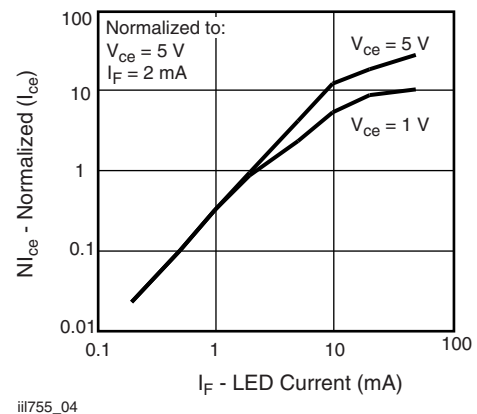
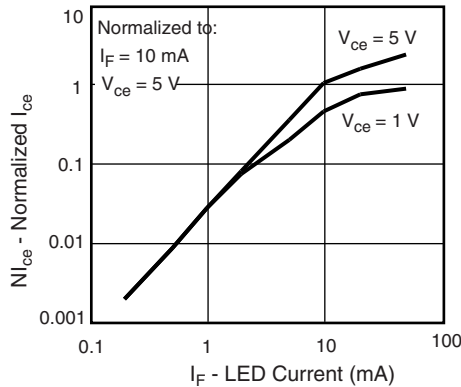

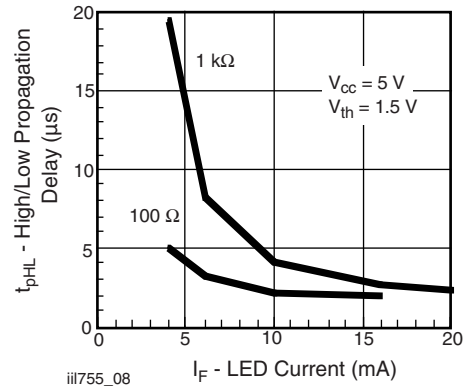
iii755\_05

Fig. 5 - Normalized Non-Saturated and Saturated Collector-Emitter Current vs. LED Current



iii755\_08

Fig. 8 - High to Low Propagation Delay vs. Collector Load Resistance and LED Current

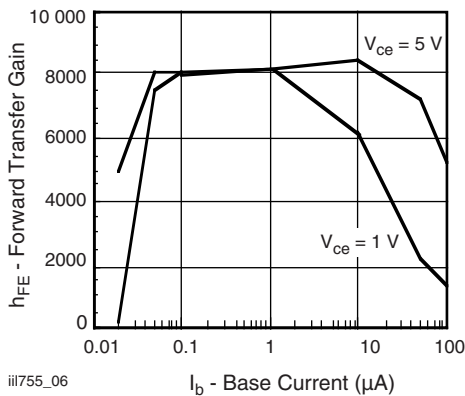

iii755\_06

Fig. 6 - Non-Saturated and Saturated  $h_{FE}$  vs. Base Current

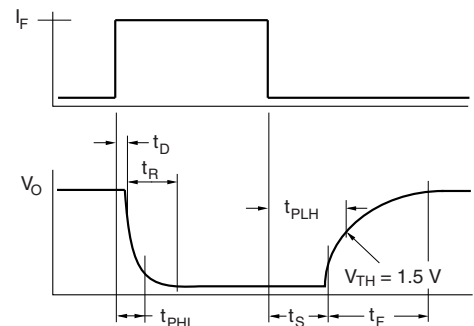

iii755\_09

Fig. 9 - Switching Waveform

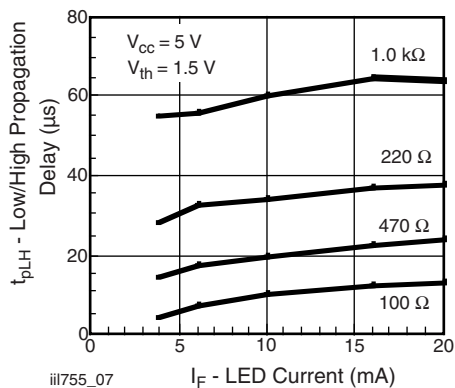

iii755\_07

Fig. 7 - Low to High Propagation Delay vs. Collector Load Resistance and LED Current

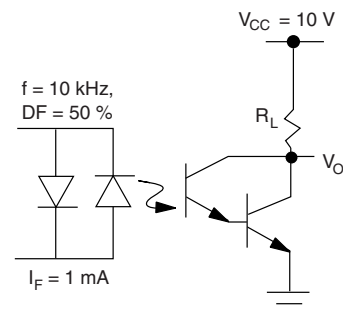

iii755\_10

Fig. 10 - Test Circuit, Saturated and Non-Saturated Operation

## PACKAGE DIMENSIONS in millimeters

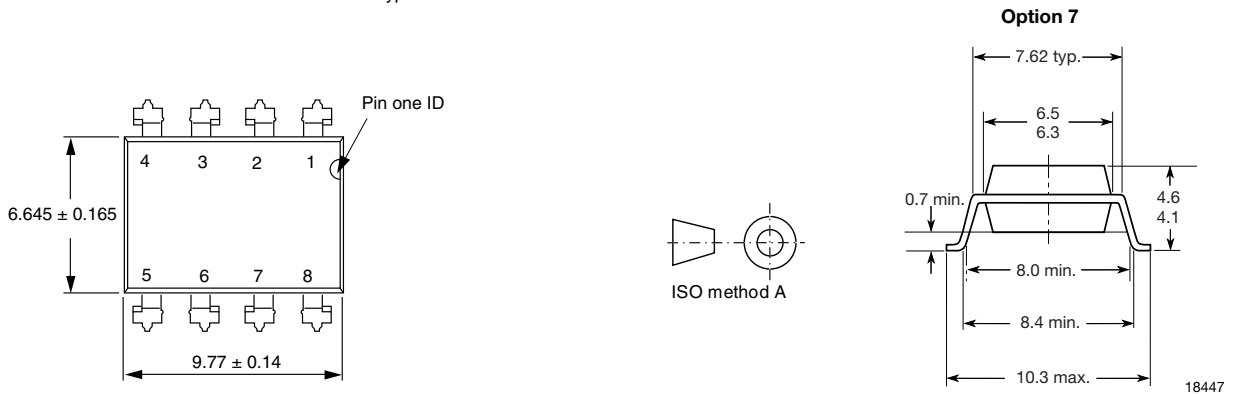
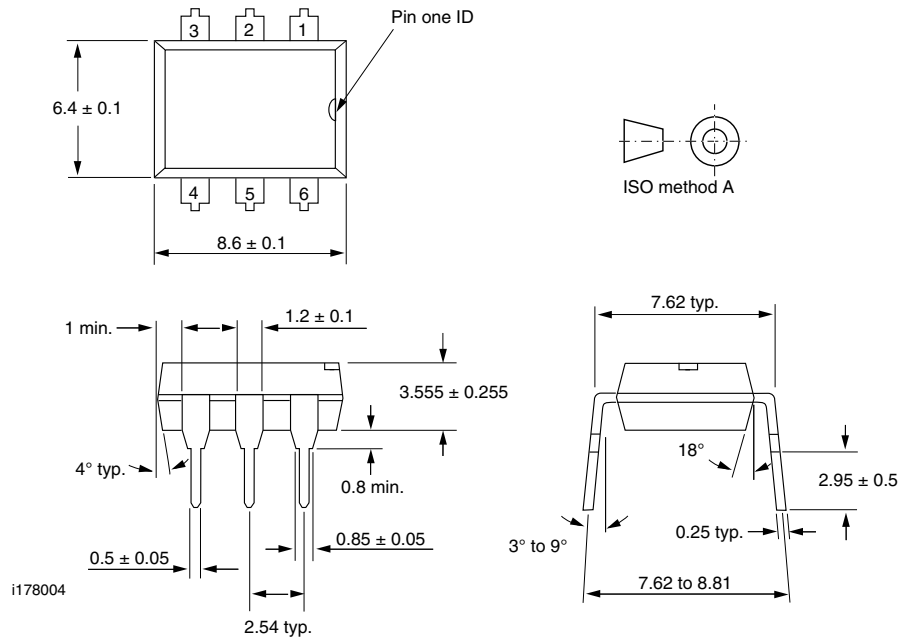

## PACKAGE MARKING (example)

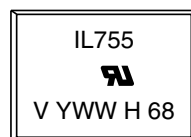

### Notes

- The VDE logo is only marked on option 1 parts.
- Tape and reel suffix (T) is not part of the package marking.



## **Disclaimer**

ALL PRODUCT, PRODUCT SPECIFICATIONS AND DATA ARE SUBJECT TO CHANGE WITHOUT NOTICE TO IMPROVE RELIABILITY, FUNCTION OR DESIGN OR OTHERWISE.

Vishay Intertechnology, Inc., its affiliates, agents, and employees, and all persons acting on its or their behalf (collectively, "Vishay"), disclaim any and all liability for any errors, inaccuracies or incompleteness contained in any datasheet or in any other disclosure relating to any product.

Vishay makes no warranty, representation or guarantee regarding the suitability of the products for any particular purpose or the continuing production of any product. To the maximum extent permitted by applicable law, Vishay disclaims (i) any and all liability arising out of the application or use of any product, (ii) any and all liability, including without limitation special, consequential or incidental damages, and (iii) any and all implied warranties, including warranties of fitness for particular purpose, non-infringement and merchantability.

Statements regarding the suitability of products for certain types of applications are based on Vishay's knowledge of typical requirements that are often placed on Vishay products in generic applications. Such statements are not binding statements about the suitability of products for a particular application. It is the customer's responsibility to validate that a particular product with the properties described in the product specification is suitable for use in a particular application. Parameters provided in datasheets and / or specifications may vary in different applications and performance may vary over time. All operating parameters, including typical parameters, must be validated for each customer application by the customer's technical experts. Product specifications do not expand or otherwise modify Vishay's terms and conditions of purchase, including but not limited to the warranty expressed therein.

Except as expressly indicated in writing, Vishay products are not designed for use in medical, life-saving, or life-sustaining applications or for any other application in which the failure of the Vishay product could result in personal injury or death. Customers using or selling Vishay products not expressly indicated for use in such applications do so at their own risk. Please contact authorized Vishay personnel to obtain written terms and conditions regarding products designed for such applications.

No license, express or implied, by estoppel or otherwise, to any intellectual property rights is granted by this document or by any conduct of Vishay. Product names and markings noted herein may be trademarks of their respective owners.