



Main

Range of product	Modicon M171/M172
Product or component type	Programmable controllers
Product specific application	HVAC and pumping solution
Variant	Programmable
Number of inputs/outputs	27
Discrete input number	8
Discrete output number	3 for relay outputs SPST with same common 2 for relay outputs SPST with same common 2 for relay outputs SPDT with independent common
Discrete output current	8 A for relay SPDT 5 A for relay SPST
Analogue input number	2 analog input NTC 4 configurable

Complementary

Number of port	1 CAN port - screw terminal block 1 USB type A - USB type A female 1 USB type mini B - USB device port Mini-B 1 RS485 - screw terminal block (Modbus serial link)
Input/Output number	6 analog input(s) 5 analog output(s) 8 digital input(s) 7 digital output(s) 1 high-speed counter(s)
Discrete input logic	Sink or source (positive/negative)
Discrete input voltage	24 V AC/DC 48 V DC
Discrete input current	2.5 mA
Input impedance	20 kOhm
Analogue input type	Impedance 0...1500 hOhm Impedance 0...300 daOhm Voltage 0...5 V (ratiometric)

Temperature probe, Pt 1000 - 200...800 °C - resolution: 0.1 °C
 Temperature probe, NTC - 50...110 °C - resolution: 0.1 °C (extended)
 Temperature probe, NTC - 40...150 °C - resolution: 0.1 °C
 Current 4...20 mA
 Voltage 0...10 V

Analogue output number	3 voltage/current, range: 4...20 mA or 0...10 V 2 open collector, range: 1 kHz, 12 V, 35 mA
Sensor power supply	5 V DC at 50 mA 12 V DC at 150 mA
[Us] rated supply voltage	24 V AC/DC (+/- 20%) 48 V DC (+/- 20%)
Power consumption in W	18 W at 24...48 V AC/DC
Realtime clock	Built-in realtime clock at -10...55 °C
Display type	LCD display - 128 x 64 pixels
Overvoltage category	II
Local signalling	1 LED red programmable 1 LED yellow programmable 1 LED green programmable
Mounting support	DIN rail
Width	140 mm
Height	110 mm
Depth	61.6 mm
Product weight	0.385 kg

Environment

Directives	2006/95/EC - low voltage directive 1907/2006/EC - REACH directive 2011/65/EU - RoHS directive 86/188/EEC - physical agents (noise) directive
Standards	EN/IEC 60730
Product certifications	CURus CSA CE EAC
Ambient air temperature for operation	-10...55 °C conforming to UL 60730-1
Ambient air temperature for storage	-20...85 °C
Relative humidity	10...90 % non-condensing
IP degree of protection	IP20
Pollution degree	2

Offer Sustainability

Sustainable offer status	Not Green Premium product
RoHS (date code: YYWW)	Compliant - since 1426 - Schneider Electric declaration of conformity Schneider Electric declaration of conformity
REACH	Reference not containing SVHC above the threshold Reference not containing SVHC above the threshold

Dimensions

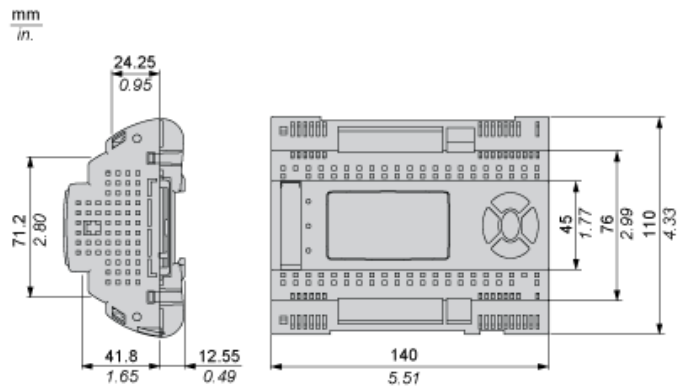

Mounting and Clearance

Clearance

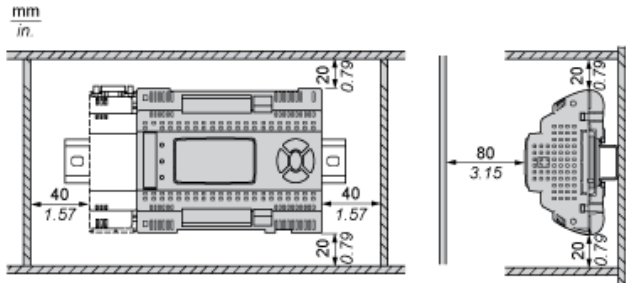

Misplacement

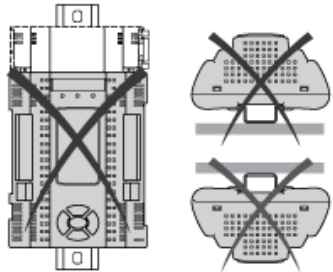

Power Supply

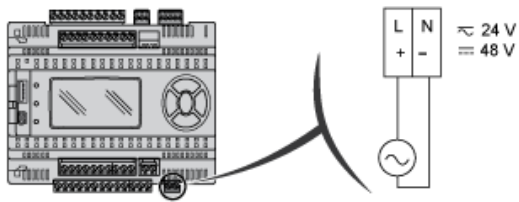

Digital Inputs

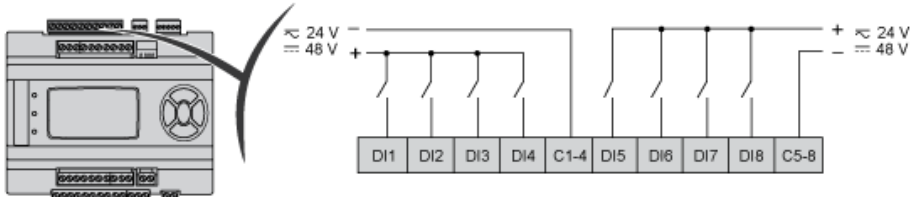

Analog Inputs

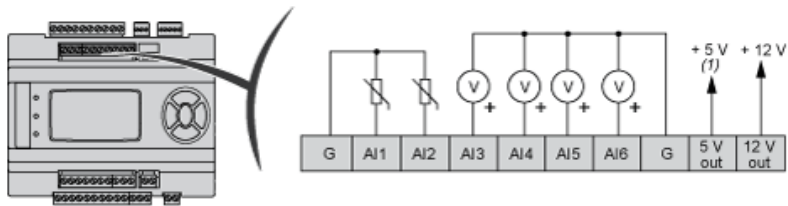

(1) Max current: 50 mA.
G : Ground

Analog Outputs

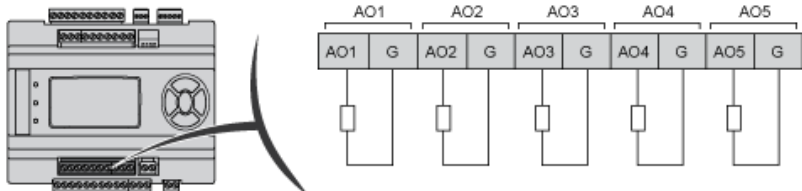

Digital Outputs

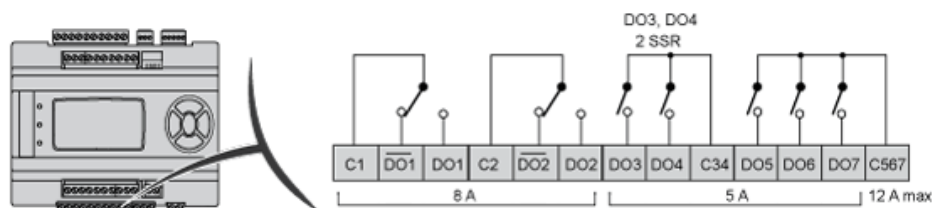

C : common

Fast Digital Input



Serial Line Port (RS 485)

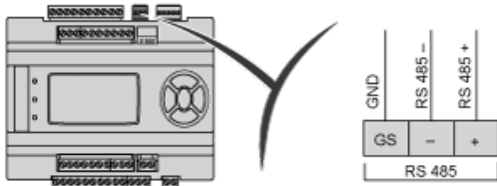

Apply 120 Ohm terminal resistance
GS serial GND isolated from G

CAN Expansion Bus

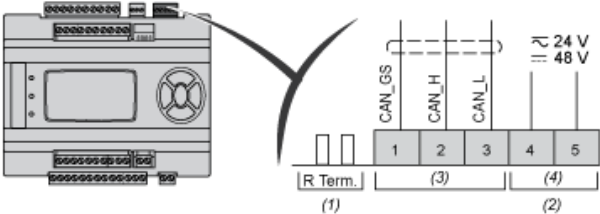

- (1) CAN terminal resistance
- (2) Output for remote keyboard
- (3) CANOPEN
- (4) Power Out

4 DipSwitches

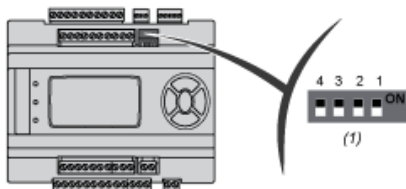

(1) 4 DIP SWITCH
LOW Address