

MCR72-3, MCR72-6, MCR72-8



Expertise Applied | Answers Delivered

Sensitive Gate Silicon Controlled Rectifiers Reverse Blocking Thyristors

Designed for industrial and consumer applications such as temperature, light and speed control; process and remote controls; warning systems; capacitive discharge circuits and MPU interface.

Features

- Center Gate Geometry for Uniform Current Density
- All Diffused and Glass-Passivated Junctions for Parameter Uniformity and Stability
- Small, Rugged Thermowatt Construction for Low Thermal Resistance, High Heat Dissipation and Durability
- Low Trigger Currents, 200 μ A Maximum for Direct Driving from Integrated Circuits
- These are Pb-Free Devices*

MAXIMUM RATINGS ($T_J = 25^\circ\text{C}$ unless otherwise noted)

Rating	Symbol	Value	Unit
Peak Repetitive Off-State Voltage (Note 1) ($T_J = -40$ to 110°C , Sine Wave, 50 Hz to 60 Hz)	V_{DRM} , V_{RRM}	100 400 600	V
On-State RMS Current (180° Conduction Angles; $T_C = 83^\circ\text{C}$)	$I_{T(RMS)}$	8.0	A
Peak Non-Repetitive Surge Current (1/2 Cycle, 60 Hz, $T_J = 110^\circ\text{C}$)	I_{TSM}	100	A
Circuit Fusing Considerations ($t = 8.3$ ms)	I^2t	40	A^2s
Forward Peak Gate Voltage ($t \leq 10$ μs , $T_C = 83^\circ\text{C}$)	V_{GM}	± 5.0	V
Forward Peak Gate Current ($t \leq 10$ μs , $T_C = 83^\circ\text{C}$)	I_{GM}	1.0	A
Forward Peak Gate Power ($t \leq 10$ μs , $T_C = 83^\circ\text{C}$)	P_{GM}	5.0	W
Average Gate Power ($t = 8.3$ ms, $T_C = 83^\circ\text{C}$)	$P_{G(AV)}$	0.75	W
Operating Junction Temperature Range	T_J	-40 to $+110$	$^\circ\text{C}$
Storage Temperature Range	T_{stg}	-40 to $+150$	$^\circ\text{C}$
Mounting Torque	–	8.0	in. lb.

Stresses exceeding those listed in the Maximum Ratings table may damage the device. If any of these limits are exceeded, device functionality should not be assumed, damage may occur and reliability may be affected.

1. V_{DRM} and V_{RRM} for all types can be applied on a continuous basis. Ratings apply for zero or negative gate voltage; however, positive gate voltage shall not be applied concurrent with negative potential on the anode. Blocking voltages shall not be tested with a constant current source such that the voltage ratings of the devices are exceeded.

Littelfuse.com

SCRs
8 AMPERES RMS
100 thru 600 VOLTS

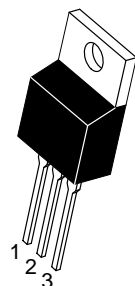

TO-220AB
CASE 221A-07
STYLE 3

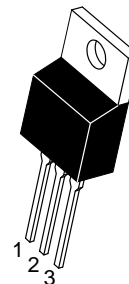

TO-220AB
CASE 221A-09
STYLE 3

PIN ASSIGNMENT

Pin	Assignment
1	Cathode
2	Anode
3	Gate
4	Anode

MARKING AND ORDERING INFORMATION

See detailed marking, ordering, and shipping information in the package dimensions section on page 4 of this data sheet.

MCR72-3, MCR72-6, MCR72-8

THERMAL CHARACTERISTICS

Characteristic	Symbol	Max	Unit
Thermal Resistance, Junction-to-Case	$R_{\theta JC}$	2.2	$^{\circ}C/W$
Thermal Resistance, Junction-to-Ambient	$R_{\theta JA}$	60	$^{\circ}C/W$
Maximum Lead Temperature for Soldering Purposes 1/8" from Case for 10 Secs	T_L	260	$^{\circ}C$

ELECTRICAL CHARACTERISTICS ($T_C = 25^{\circ}C$ unless otherwise noted.)

Characteristic	Symbol	Min	Typ	Max	Unit
----------------	--------	-----	-----	-----	------

OFF CHARACTERISTICS

Peak Repetitive Forward or Reverse Blocking Current (Note 2) ($V_{AK} = \text{Rated } V_{DRM} \text{ or } V_{RRM}; R_{GK} = 1 \text{ k}\Omega$)	I_{DRM}, I_{RRM}	-	-	10	μA
		-	-	500	μA
High Logic Level Supply Current from V_{CC}	I_{CCH}	4	4	μA	μA

ON CHARACTERISTICS

Peak Forward On-State Voltage ($I_{TM} = 16 \text{ A Peak, Pulse Width} \leq 1 \text{ ms, Duty Cycle} \leq 2\%$)	V_{TM}	-	1.7	2.0	V
Gate Trigger Current (Continuous dc) (Note 3) ($V_D = 12 \text{ V, } R_L = 100 \Omega$)	I_{GT}	-	30	200	μA
Gate Trigger Voltage (Continuous dc) (Note 3) ($V_D = 12 \text{ V, } R_L = 100 \Omega$)	V_{GT}	-	0.5	1.5	V
Gate Non-Trigger Voltage ($V_D = 12 \text{ Vdc, } R_L = 100 \Omega, T_J = 110^{\circ}C$)	V_{GD}	0.1	-	-	V
Holding Current ($V_D = 12 \text{ V, Initiating Current} = 200 \text{ mA, } R_{GK} = 1 \text{ k}\Omega$)	I_H	-	-	6.0	mA
Gate Controlled Turn-On Time ($V_D = \text{Rated } V_{DRM}, I_{TM} = 16 \text{ A, } I_G = 2 \text{ mA}$)	t_{gt}	-	1.0	-	μs

DYNAMIC CHARACTERISTICS

Critical Rate-of-Rise of Off-State Voltage ($V_D = \text{Rated } V_{DRM}, R_{GK} = 1 \text{ k}\Omega, T_J = 110^{\circ}C, \text{ Exponential Waveform}$)	dv/dt	-	10	-	$V/\mu s$
---	---------	---	----	---	-----------

Product parametric performance is indicated in the Electrical Characteristics for the listed test conditions, unless otherwise noted. Product performance may not be indicated by the Electrical Characteristics if operated under different conditions.

- Ratings apply for negative gate voltage or $R_{GK} = 1 \text{ k}\Omega$. Devices shall not have a positive gate voltage concurrently with a negative voltage on the anode. Devices should not be tested with a constant current source for forward and reverse blocking capability such that the voltage applied exceeds the rated blocking voltage.
- R_{GK} current not included in measurement.

MCR72-3, MCR72-6, MCR72-8

Voltage Current Characteristic of SCR

Symbol	Parameter
V_{DRM}	Peak Repetitive Off State Forward Voltage
I_{DRM}	Peak Forward Blocking Current
V_{RRM}	Peak Repetitive Off State Reverse Voltage
I_{RRM}	Peak Reverse Blocking Current
V_{TM}	Peak On State Voltage
I_H	Holding Current

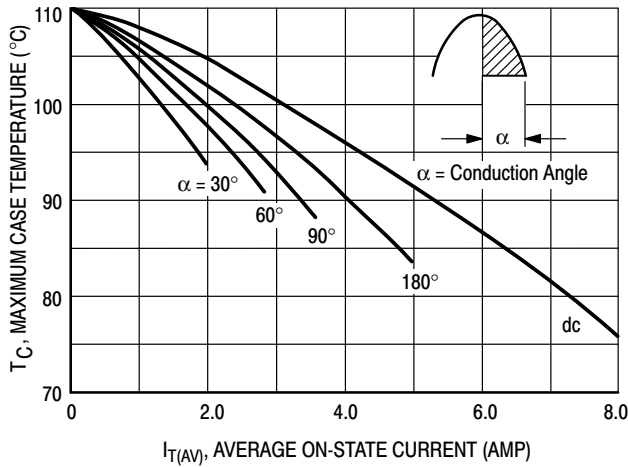
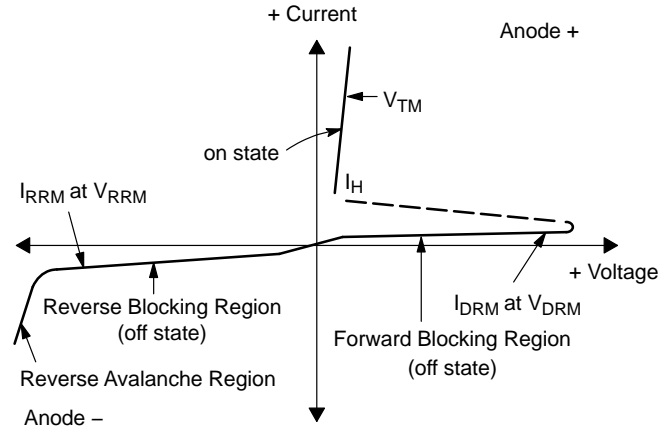

Figure 1. Average Current Derating

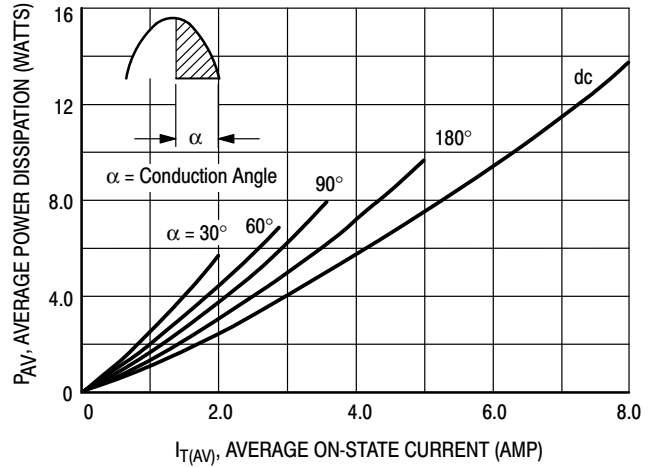

Figure 2. On-State Power Dissipation

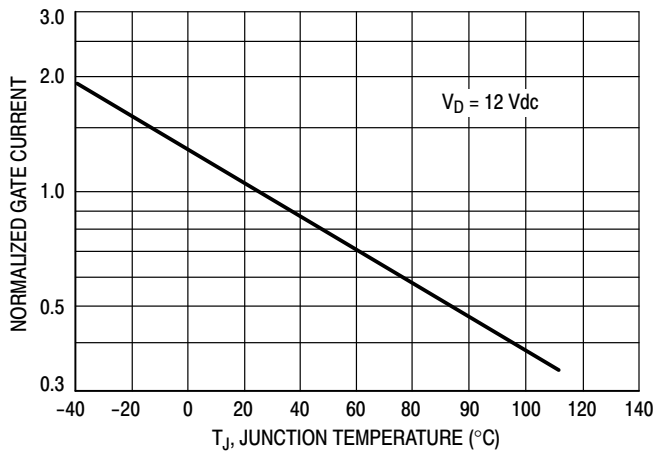

Figure 3. Normalized Gate Current

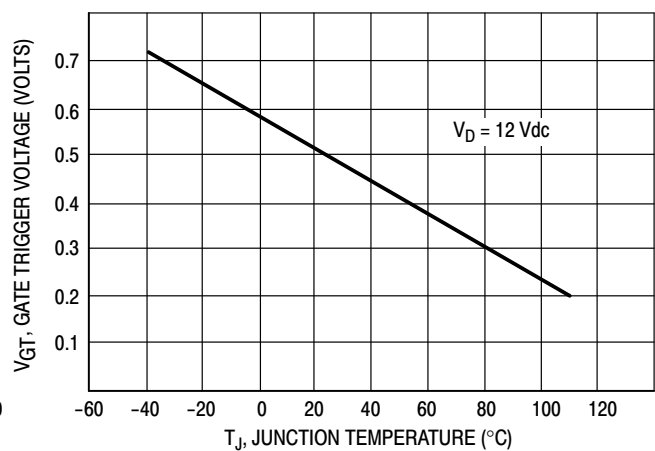
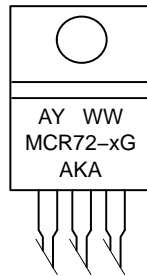

Figure 4. Gate Voltage

MCR72-3, MCR72-6, MCR72-8

MARKING DIAGRAMS

**TO-220AB
CASE 221A-07**



**TO-220AB
CASE 221A-09**

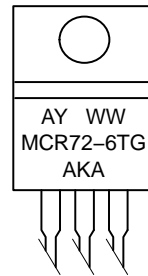

A = Assembly Location
 Y = Year
 WW = Work Week
 MCR72-x = Device Code
 x = 3, 6, 8, or 8T
 G = Pb-Free Package
 AKA = Diode Polarity

A = Assembly Location
 Y = Year
 WW = Work Week
 MCR72-6T = Device Code
 G = Pb-Free Package
 AKA = Diode Polarity

ORDERING INFORMATION

Device	Package	Shipping
MCR72-3G	TO-220AB (Pb-Free)	500 Units / Box
MCR72-6G	TO-220AB (Pb-Free)	500 Units / Box
MCR72-6TG	TO-220AB (Pb-Free)	50 Units / Rail
MCR72-8G	TO-220AB (Pb-Free)	500 Units / Box
MCR72-8TG	TO-220AB (Pb-Free)	50 Units / Rail

MCR72-3, MCR72-6, MCR72-8

PACKAGE DIMENSIONS

TO-220
CASE 221A-07
ISSUE O

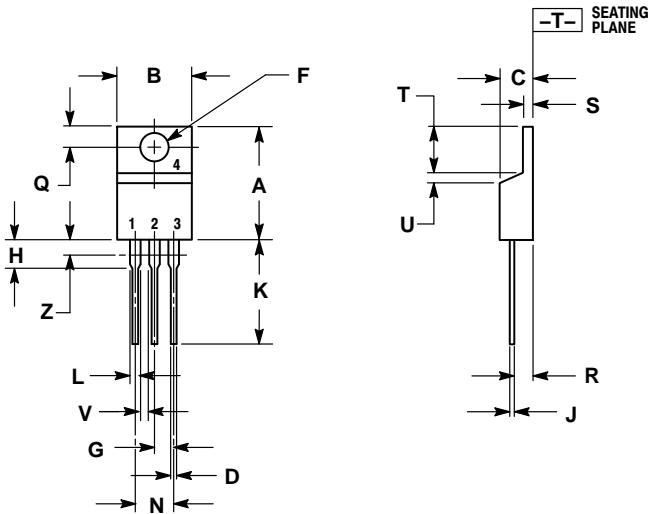

NOTES:

1. DIMENSIONING AND TOLERANCING PER ANSI Y14.5M, 1982.
2. CONTROLLING DIMENSION: INCH.
3. DIMENSION Z DEFINES A ZONE WHERE ALL BODY AND LEAD IRREGULARITIES ARE ALLOWED.

DIM	INCHES		MILLIMETERS	
	MIN	MAX	MIN	MAX
A	0.570	0.620	14.48	15.75
B	0.380	0.405	9.66	10.28
C	0.160	0.190	4.07	4.82
D	0.025	0.035	0.64	0.88
F	0.142	0.147	3.61	3.73
G	0.095	0.105	2.42	2.66
H	0.110	0.155	2.80	3.93
J	0.014	0.022	0.36	0.55
K	0.500	0.562	12.70	14.27
L	0.045	0.060	1.15	1.52
N	0.190	0.210	4.83	5.33
Q	0.100	0.120	2.54	3.04
R	0.080	0.110	2.04	2.79
S	0.045	0.055	1.15	1.39
T	0.235	0.255	5.97	6.47
U	0.000	0.050	0.00	1.27
V	0.045	---	1.15	---
Z	---	0.080	---	2.04

STYLE 3:

1. CATHODE
2. ANODE
3. GATE
4. ANODE

MCR72-3, MCR72-6, MCR72-8

PACKAGE DIMENSIONS

TO-220
CASE 221A-09
ISSUE AH

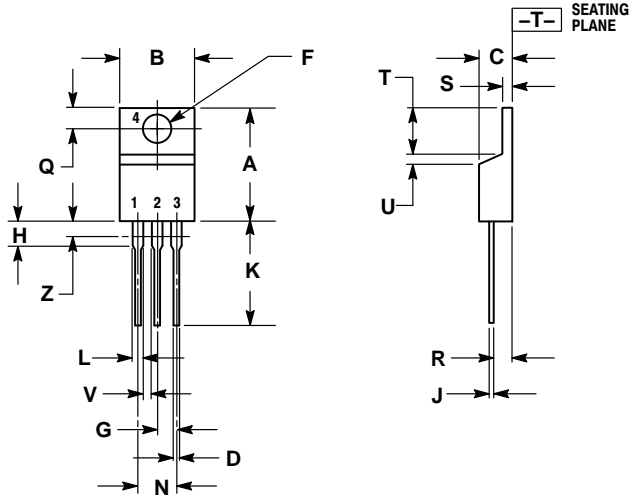

NOTES:

1. DIMENSIONING AND TOLERANCING PER ANSI Y14.5M, 1982.
2. CONTROLLING DIMENSION: INCH.
3. DIMENSION Z DEFINES A ZONE WHERE ALL BODY AND LEAD IRREGULARITIES ARE ALLOWED.

DIM	INCHES		MILLIMETERS	
	MIN	MAX	MIN	MAX
A	0.570	0.620	14.48	15.75
B	0.380	0.415	9.66	10.53
C	0.160	0.190	4.07	4.83
D	0.025	0.038	0.64	0.96
F	0.142	0.161	3.61	4.09
G	0.095	0.105	2.42	2.66
H	0.110	0.161	2.80	4.10
J	0.014	0.024	0.36	0.61
K	0.500	0.562	12.70	14.27
L	0.045	0.060	1.15	1.52
N	0.190	0.210	4.83	5.33
Q	0.100	0.120	2.54	3.04
R	0.080	0.110	2.04	2.79
S	0.045	0.055	1.15	1.39
T	0.235	0.255	5.97	6.47
U	0.000	0.050	0.00	1.27
V	0.045	---	1.15	---
Z	---	0.080	---	2.04

STYLE 3:

- PIN 1. CATHODE
2. ANODE
3. GATE
4. ANODE

Littelfuse products are not designed for, and shall not be used for, any purpose (including, without limitation, automotive, military, aerospace, medical, life-saving, life-sustaining or nuclear facility applications, devices intended for surgical implant into the body, or any other application in which the failure or lack of desired operation of the product may result in personal injury, death, or property damage) other than those expressly set forth in applicable Littelfuse product documentation. Warranties granted by Littelfuse shall be deemed void for products used for any purpose not expressly set forth in applicable Littelfuse documentation. Littelfuse shall not be liable for any claims or damages arising out of products used in applications not expressly intended by Littelfuse as set forth in applicable Littelfuse documentation. The sale and use of Littelfuse products is subject to Littelfuse Terms and Conditions of Sale, unless otherwise agreed by Littelfuse.

Littelfuse.com