

**PLEASE CHECK WWW.MOLEX.COM FOR LATEST PART INFORMATION**

**Part Number:** [0039532084](#)  
**Status:** **Active**  
**Overview:** FFC-FPC (Through-Hole)  
**Description:** FFC/FPC Connector, Through-Hole, Right-Angle, ZIF, Top Contact Style, 8 Circuits

**Documents:**

[3D Model](#) [Packaging Specification SPK-5597-003-001 \(PDF\)](#)  
[Drawing \(PDF\)](#) [RoHS Certificate of Compliance \(PDF\)](#)  
[Product Specification PS-5597-004-001 \(PDF\)](#)

**Agency Certification**

UL E29179

**General**

Product Family FFC/FPC Connectors  
 Series [5597](#)  
 Overview [FFC-FPC \(Through-Hole\)](#)  
 Product Name N/A  
 UPC 822348170159

**Physical**

Circuits (Loaded) 8  
 Color - Resin Natural  
 Contact Position Top  
 Durability (mating cycles max) 30  
 Entry Angle 90° Angle  
 Flammability 94V-0  
 Mated Height 5.00mm  
 Material - Metal Phosphor Bronze  
 Material - Plating Mating Tin-Bismuth  
 Material - Plating Termination Tin-Bismuth  
 Material - Resin Polyester  
 Net Weight 809.750/mg  
 Number of Rows 1  
 Orientation Right Angle  
 PC Tail Length 3.50mm  
 PCB Locator No  
 PCB Retention None  
 Packaging Type Tray  
 Pitch - Mating Interface 1.25mm  
 Plating min - Mating 1.016µm  
 Plating min - Termination 1.016µm  
 Polarized to PCB No  
 Stackable No  
 Surface Mount Compatible (SMC) No  
 Temperature Range - Operating -20°C to +80°C  
 Termination Interface: Style Through Hole  
 Wire/Cable Type FFC/FPC

**Electrical**

Current - Maximum per Contact 1.0A  
 Voltage - Maximum 200V

**Material Info**

Engineering Number 5597-08APB7F

**Reference - Drawing Numbers**

Packaging Specification SPK-5597-003-001

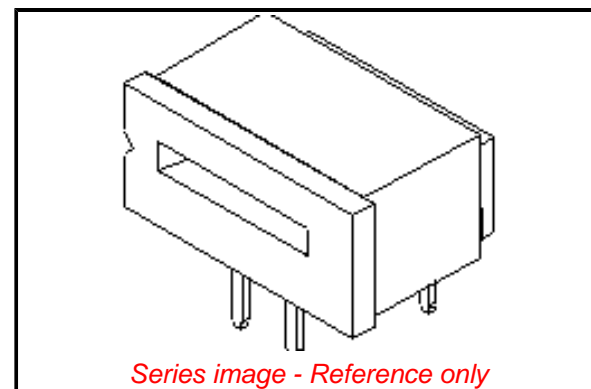

Series image - Reference only

**EU ELV**

**Not Relevant**

**EU RoHS**

**Compliant**

**REACH SVHC**

Not Contained Per -  
 ED/21/2016 (20 June  
 2016)

**Halogen-Free**

**Status**

**Not Low-Halogen**

**Need more information on product  
 environmental compliance?**

Email [productcompliance@molex.com](mailto:productcompliance@molex.com)  
 Please visit the [Contact Us](#) section for any  
 non-product compliance questions.

China ROHS

ELV

RoHS Phthalates

Green Image

Not Relevant

Not Contained

**Search Parts in this Series**

[5597 Series](#)

This document was generated on 12/27/2016

**PLEASE CHECK [WWW.MOLEX.COM](http://WWW.MOLEX.COM) FOR LATEST PART INFORMATION**