

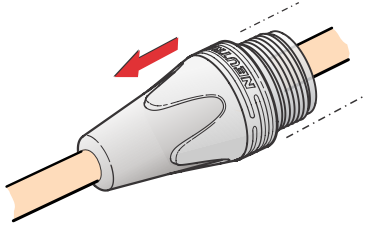

# ASSEMBLY INSTRUCTION

## NC10FXX & NC10MXX | XLR Cable Connector

(A)



(A) Slide the boot onto the cable.

(B) Cable O.D. 8.0 - 10.0 mm  
[0.315" - 0.394"]

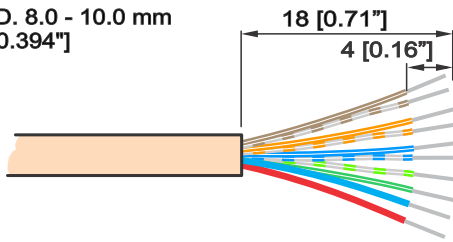

(B) Prepare the cable as shown.

(C) Insert the wires into the terminals and solder them.

(C)

**SOLDER**

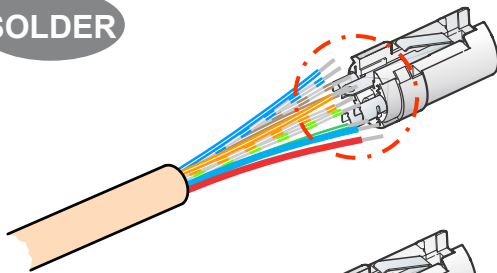

Wiring suggestion under consideration of EIA/TIA 568 A/B.

Solder side!	Connection		PIN No.
	T568A	T568B	
Female 	W - G	W - O	1
	G	O	2
	W - O	W - G	3
	BL	BL	4
	W - BL	W - BL	5
	O	G	6
	W - BR	W - BR	7
	BR	BR	8
Power DC			
	+		9
	-		10

(D)

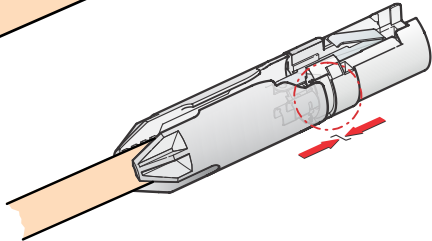

(D) Put the chuck onto the cable.  
**Attention: Pay attention to the guiding key.**

(E) Slide the insert and the chuck together into the housing.

(E)

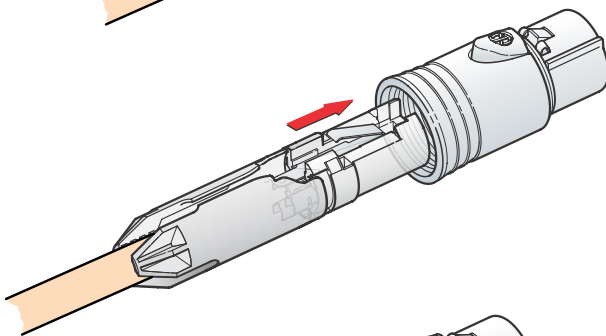

(F) Finish the installation by turning the bushing onto the connector.

(F)

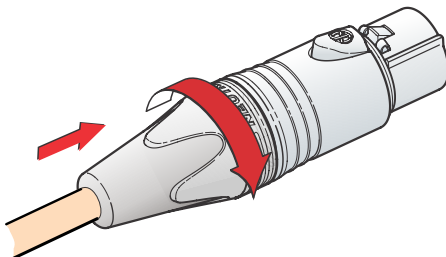

OPTION:

Use the handtool HTXX-14 to tighten the bushing.

### ORDER OF ASSEMBLY

NC10FXX



bushing

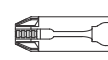

chuck



insert

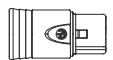

housing

NC10MXX

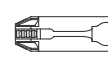

NEUTRIK AG LI T: +423/237 24 24 F: +423/232 53 93  
 NEUTRIK USA Inc. USA T: +1 704 / 972 3050 F: +1 704/438 9202  
 NEUTRIK (UK) Ltd. UK T: +44 1983 / 811 441 F: +44 1983/811 439  
 NEUTRIK Vertriebs GmbH DE/NL/AT/DK T: +49 8131 / 280 890 F: +49 8131/280 830

NEUTRIK France FR T: +33 1/4131 6750 F: +33 1/4131 0511  
 NEUTRIK Tokyo Ltd. JP T: +81 3/3663 4733 F: +81 3/3663 4796  
 NEUTRIK Hong Kong Ltd. HK T: +852/2687 6055 F: +852/2687 6052  
 NEUTRIK India Pvt. Ltd. IND T: +91/982 05 43 424 F: +91/22 26163 540

Draft. Nr.: BDA 482 | Update: 29.03.2016 | Data subject to change without prior notice. ©2016 NEUTRIK®. ALL RIGHTS RESERVED. NEUTRIK® are registered trademark.

www.neutrik.com

**NEUTRIK®**