



# SPECIFICATION FOR APPROVAL

CUSTOMER: \_\_\_\_\_

DESCRIPTION: I.T.E. POWER SUPPLY REV: (A0)

MODEL NO: HK-AY-050A300-CP PART NO: HKSC-161219

DESIGNED NO: 161219-1219 DATE: DEC.19th.2016

CUSTOMER APPROVED SIGNATURES			VENDOR APPROVED SIGNATURES		
					



MODEL NO. :	HK-AY-050A300-CP	PAGE NO. :	1 OF 15
PART NO. :	HKSC-161219	ISSUED DATE:	2016.12.19
DESCRIPTION :	I.T.E. POWER SUPPLY	REV:	(A0)

## CONTENTS

1. INTRODUCTION
2. INPUT REQUIREMENTS
3. OUTPUT REQUIREMENTS
4. EFFICIENCY
5. LINE REGULATION
6. HOLD UP TIME
7. TURN ON TIME
8. TEMPERATURE COEFFICIENT
9. DIELECTRIC STRENGTH (Hi-Pot) TEST
10. INSULATION RESISTANCE
11. PROTECTION
12. ENVIRONMENTAL CONDITIONS
13. EMI/ EMC
14. RELIABILITY AND QUALITY CONTROL
15. SAFETY
16. OVERALL DRAWING
17. PACKING
18. MARKING
19. TEST REPORT

MODEL NO. :	HK-AY-050A300-CP	PAGE NO. :	2 OF 15
PART NO. :	HKSC-161219	ISSUED DATE:	2016.12.19
DESCRIPTION :	I.T.E. POWER SUPPLY	REV:	(A0)

## 1.0 INTRODUCTION

This document specifies a switching power supply with a output of +5V, and electronic process. The switching power supply will provide power for technology equipments including electrical business equipment. The adaptor meets the requirement of lead free and RoHS.

## 2.0 INPUT REQUIREMENTS

2.1 Input Voltage Range: 100(-10%)VAC to 240(+10%)VAC

2.2 Input Frequency Range: 47 Hz to 63 Hz

2.3 Input Power Consumption at no-load : 0.1W Max

2.4 Input In-rush Current: 60A Max

Test condition will be tested after No load operating for 30min then measure it.

2.5 Input Current: 0.8A Max

## 3.0 OUTPUT REQUIREMENTS

3.1 Output Voltage: +5V

3.2 Output Regulation: 4.75-5.25V

3.3 Output Load Range: 0-3.0A

3.4 Output Ripple & Noise: 200mV Max @20MHz bandwidth with

10UF/50V capacitance and 104/50V ceramic capacitor.

4.0 EFFICIENCY:  $\geq 84.13\%$ @average of 25/50/75/100% loads 115&230VAC input

Test condition will be tested after full load operating for 30min then measure it.

5.0 LINE REGULATION:  $\pm 2\%$  maximum

6.0 HOLD UP TIME: 10ms Min at 110VAC full load.

7.0 TURN ON TIME: 2S Max at 110VAC full load.

MODEL NO. :	HK-AY-050A300-CP	PAGE NO. :	3 OF 15
PART NO. :	HKSC-161219	ISSUED DATE:	2016.12.19
DESCRIPTION :	I.T.E. POWER SUPPLY	REV:	(A0)

8.0 TEMPERATURE COEFFICIENT: 0.05%/°C

9.0 DIELECTRIC STRENGTH (Hi-Pot) TEST

9.1 Primary to Secondary :AC 3000 Vrms ,4mA,1minute for type test,  
2 second for production test.

10.0 INSULATION RESISTANCE

Primary to secondary: 50M OHM to 500VDC.

11.0 PROTECTION

11.1 Input Protection

The switching power supply has a 2 Amps inner current fuse to protect itself.

11.2 Output Protection

11.2.1 Output Current:

Overload conditions shall decrease the output current. Removal of an output overload shall provide automatic recovery for the output voltage.

11.2.2 Short Circuit Protection: Auto Recovery.

MODEL NO. :	HK-AY-050A300-CP	PAGE NO. :	4 OF 15
PART NO. :	HKSC-161219	ISSUED DATE:	2016.12.19
DESCRIPTION :	I.T.E. POWER SUPPLY	REV:	(A0)

## 12.0 ENVIRONMENTAL CONDITIONS

The switching power supply can withstand the following environmental conditions:

12.1 Storage Temperature: -20°C ~ +70 °C

Relative Humidity: 10% ~ 95%

12.2 Operation Temperature: 0°C~40°C

Relative Humidity: 10%~95%

## 13.0 EMI / EMC

The switching power supply has designed to meet the following safety standards:

FCC PART 15 Class B

CISPR 22:2008(Ed 6.0)AS/NZS CISPR 22:2009+A1:2010; CISPR 24:2010(Ed 2.0)AS/NZS CISPR 24:2013

EN55022:2010/AC:2011 IEC61000-4-3:2006/A1:2007/A2:2010

EN61000-3-2:2014 IEC61000-4-4:2012

EN61000-3-3:2013 IEC61000-4-5:2014

EN55024:2010 IEC61000-4-6:2013

IEC61000-4-2:2008 IEC61000-4-8:2009

IEC61000-4-11:2004

## 14.0 RELIABILITY AND QUALITY CONTROL

### 14.1 Burn-in

The burn-in test will be performed at least 2 hours at 40 centigrade degrees under full load condition.

### 14.2 MTBF

When the operation is complying with this specification, the switching power supply s MTBF will be 50,000 hours at 25 centigrade degrees.

## 15.0 SAFETY

The switching power supply has designed to meet the following safety standards:

UL 60950-1, 2nd Edition,2014-10-14 CSA C22.2 NO.60950-1-07, 2nd Edition,2014-10

EN60950-1:2006+A11+A1+A12+A2 BS EN60950-1:2006+A2

AS/NZS 60950.1:2015



MODEL NO. :	HK-AY-050A300-CP	PAGE NO. :	5 OF 15
PART NO. :	HKSC-161219	ISSUED DATE:	2016.12.19
DESCRIPTION :	I.T.E. POWER SUPPLY	REV:	(A0)

### 16. OVERALL DRAWING

UNIT: mm  
COLOR: BLACK

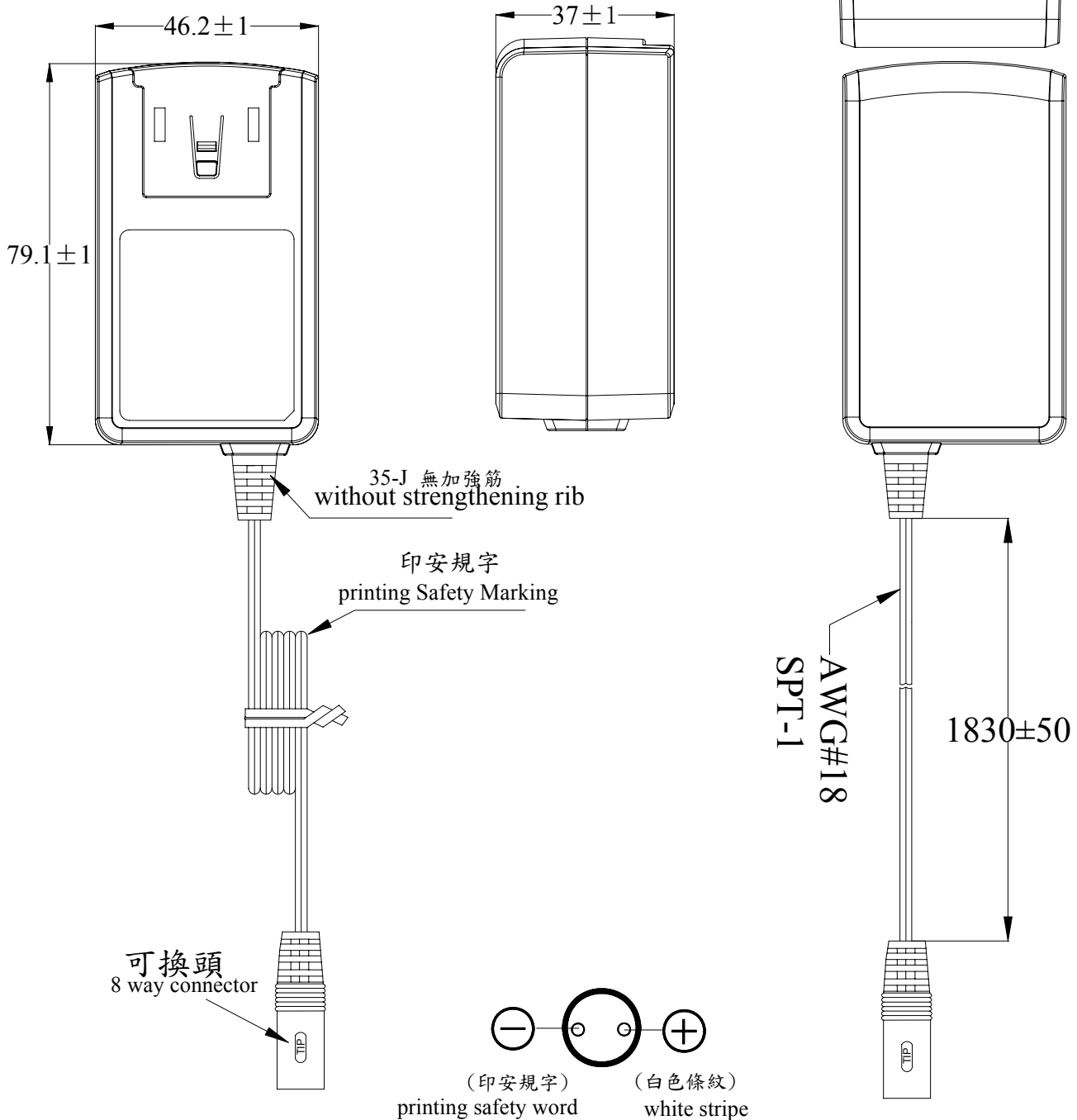



MODEL NO. :	HK-AY-050A300-CP	PAGE NO. :	6 OF 15
PART NO. :	HKSC-161219	ISSUED DATE:	2016.12.19
DESCRIPTION :	I.T.E. POWER SUPPLY	REV:	(A0)

UNIT: mm

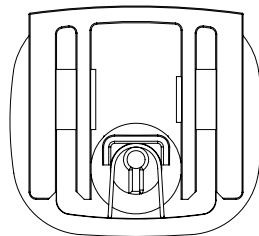
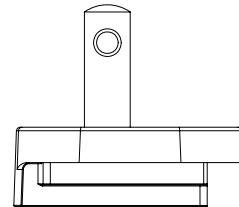
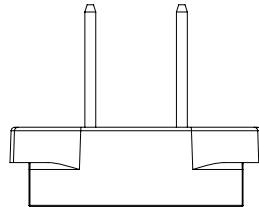
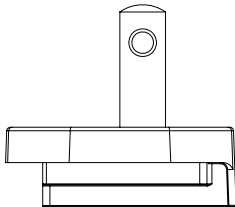
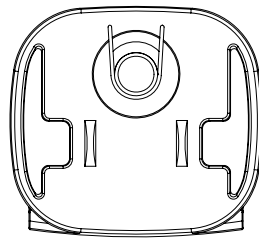

UL





MODEL NO. :	HK-AY-050A300-CP	PAGE NO. :	7 OF 15
PART NO. :	HKSC-161219	ISSUED DATE:	2016.12.19
DESCRIPTION :	I.T.E. POWER SUPPLY	REV:	(A0)

UNIT: mm

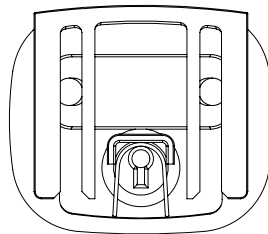
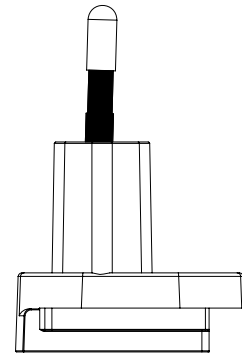
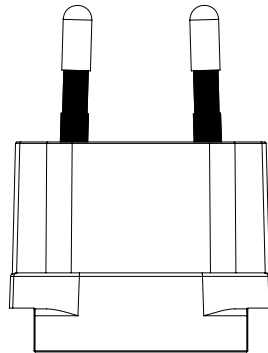
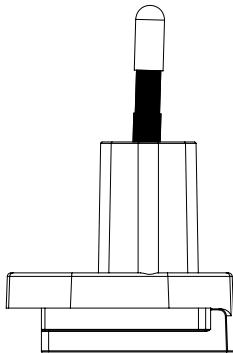
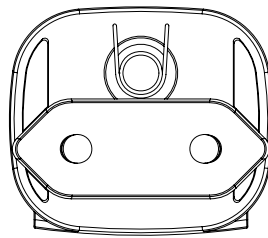

TUV



MODEL NO. :	HK-AY-050A300-CP	PAGE NO. :	8 OF 15
PART NO. :	HKSC-161219	ISSUED DATE:	2016.12.19
DESCRIPTION :	I.T.E. POWER SUPPLY	REV:	(A0)

UNIT: mm

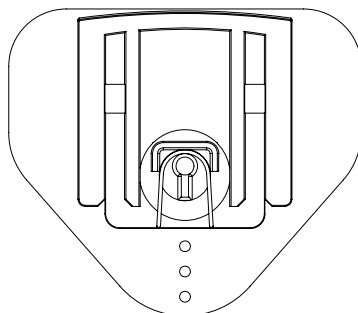
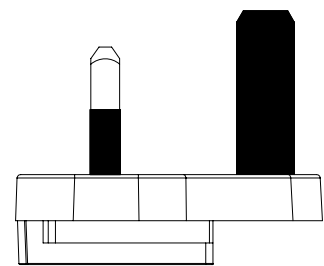
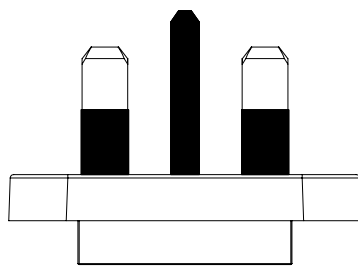
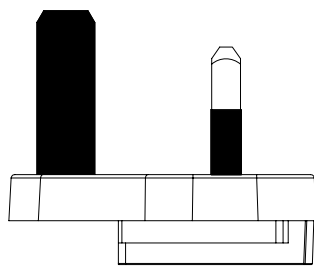
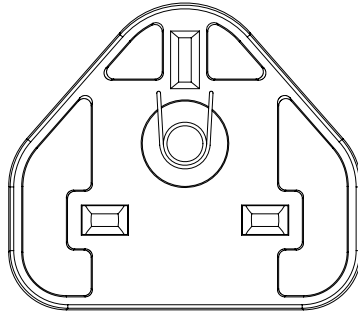

UK



MODEL NO. :	HK-AY-050A300-CP	PAGE NO. :	9 OF 15
PART NO. :	HKSC-161219	ISSUED DATE:	2016.12.19
DESCRIPTION :	I.T.E. POWER SUPPLY	REV:	(A0)

UNIT: mm

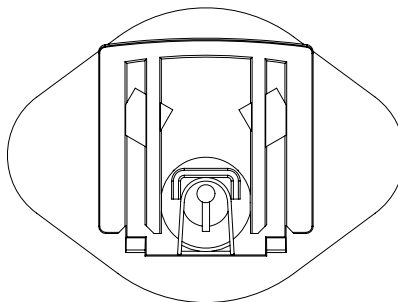
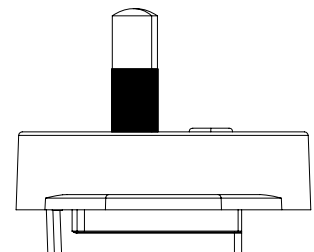
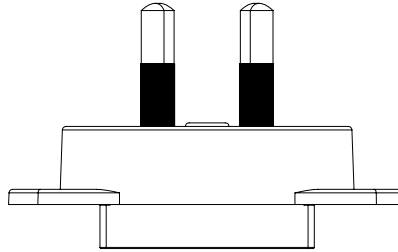
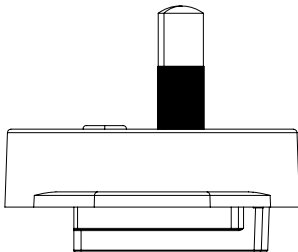
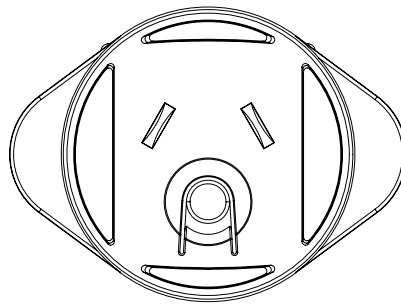

**SAA**



MODEL NO. :	HK-AY-050A300-CP	PAGE NO. :	10 OF 15
PART NO. :	HKSC-161219	ISSUED DATE:	2016.12.19
DESCRIPTION :	I.T.E. POWER SUPPLY	REV:	(A0)

UNIT: mm

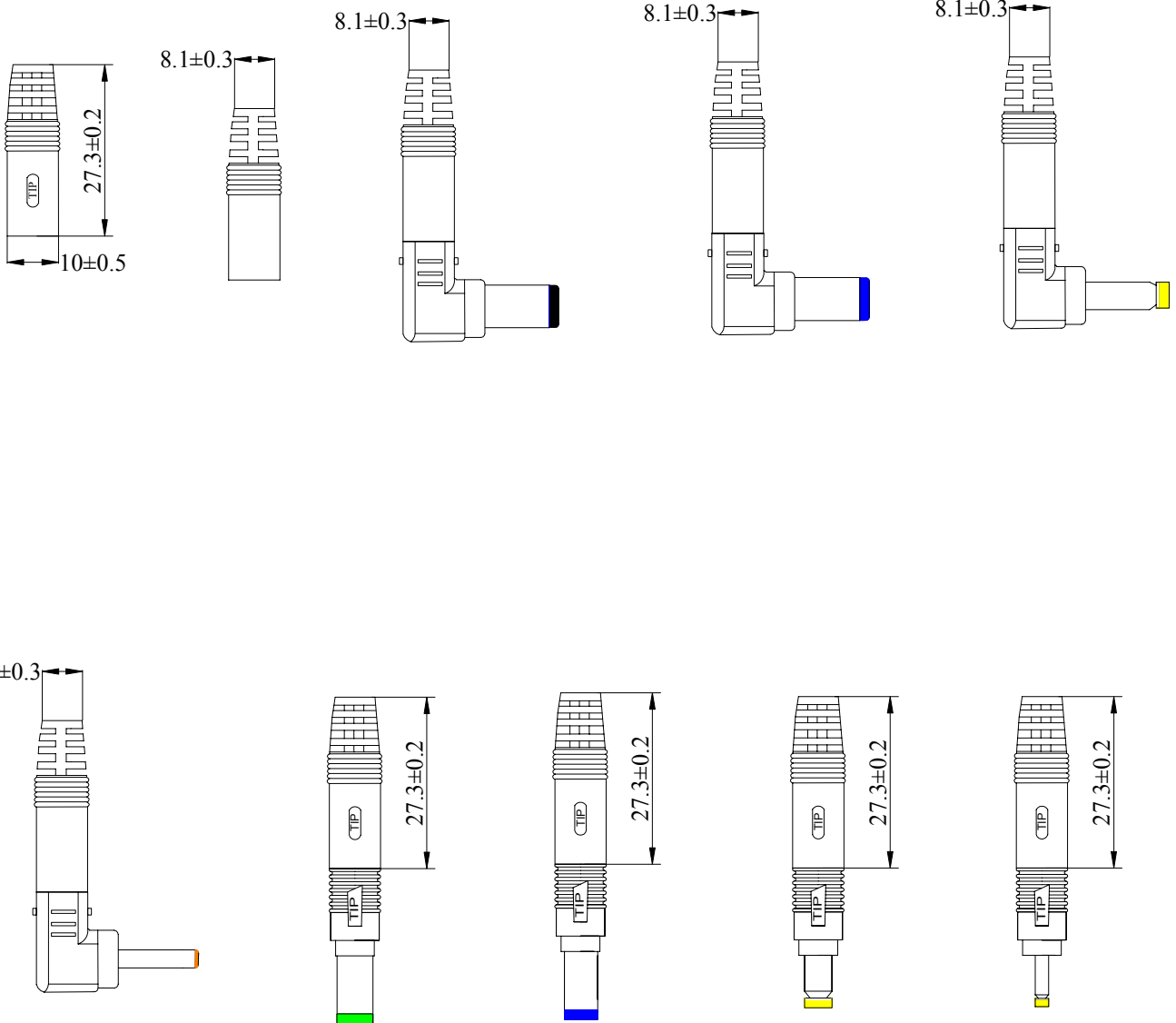



MODEL NO. :	HK-AY-050A300-CP	PAGE NO. :	11 OF 15
PART NO. :	HKSC-161219	ISSUED DATE:	2016.12.19
DESCRIPTION :	I.T.E. POWER SUPPLY	REV:	(A0)

UNIT: mm

## WARNING!

Please don't insert article alone at the wall.

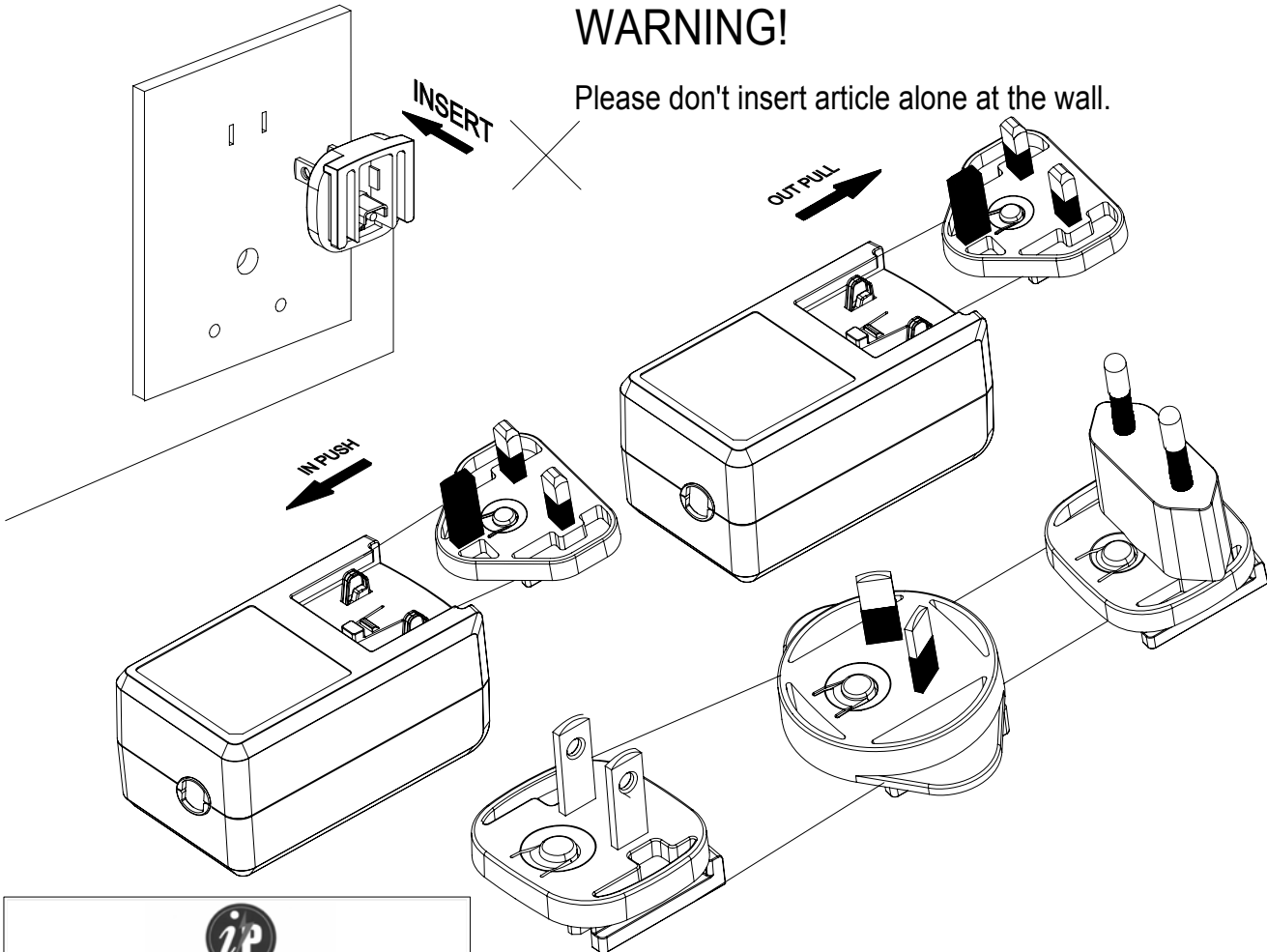

### Output connector instructions.

Supplied by Ideal Power Ltd, Acorn House, Tree Beech Enterprise Park, Gunn, Barnstaple, Devon, England EX32 7NZ Tel. +44 (0) 845 2603400

Please ensure the correct polarity is observed before connecting to any user equipment.

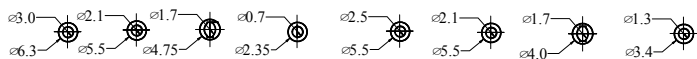
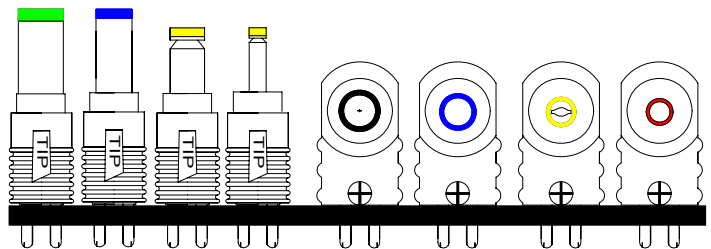
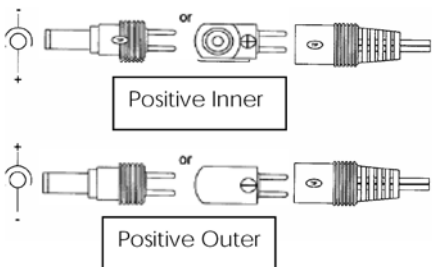

Instruction manual card

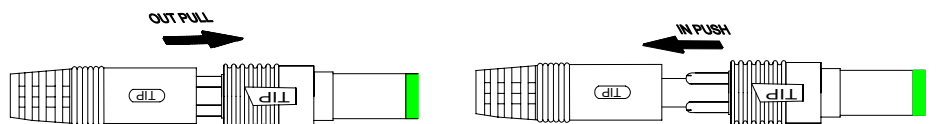

MODEL NO. :	HK-AY-050A300-CP	PAGE NO. :	12 OF 15
PART NO. :	HKSC-161219	ISSUED DATE:	2016.12.19
DESCRIPTION :	I.T.E. POWER SUPPLY	REV:	(A0)

## 17. PACKING

### 17.1 Inner Box

UNIT: mm

BOX(  Normal BOX  Corrugated BOX)

Length:120

Width: 75

Height: 50

Label: 1

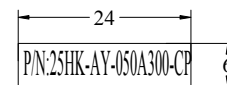

Label: 2

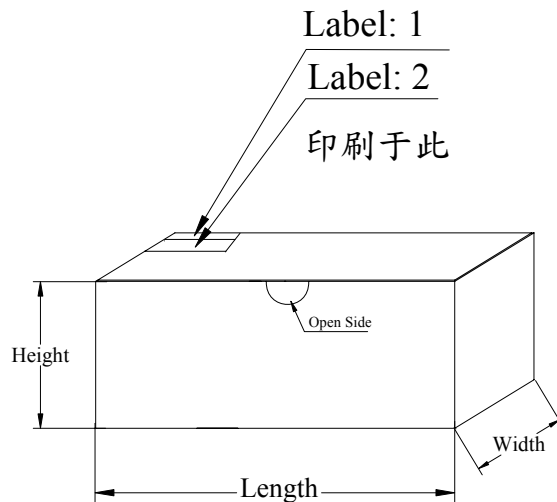
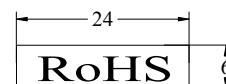

### NOTICE:

Its probably different from the white box of the sample and the figure dimension.  
The white box is used to pack during product.

注意:樣品使用的小白盒尺寸可能與此圖面尺寸不同,此圖面尺寸是用于生產時的包裝.

MODEL NO. :	HK-AY-050A300-CP	PAGE NO. :	13 OF 15
PART NO. :	HKSC-161219	ISSUED DATE:	2016.12.19
DESCRIPTION :	I.T.E. POWER SUPPLY	REV:	(A0)

## 17. PACKING

### 17.2 Carton

UNIT: mm

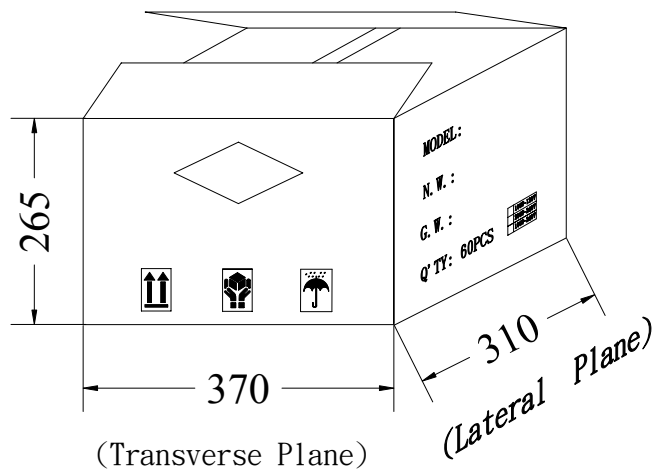
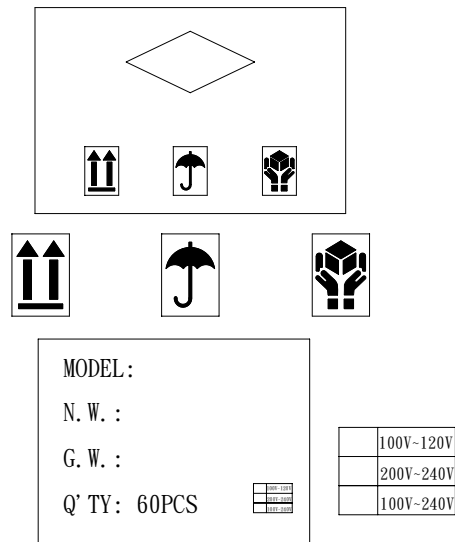



**IDEALPOWER**  
experts in power conversion

MODEL NO. :	HK-AY-050A300-CP	PAGE NO. :	14 OF 15
PART NO. :	HKSC-161219	ISSUED DATE:	2016.12.19
DESCRIPTION :	I.T.E. POWER SUPPLY	REV:	(A0)

18. MARKING

100# CPC 壓花底+上光 NAME-PLATE:WHITE CHARACTERS BLACK BACKGROUND.

UNIT: mm M M Y Y C

