

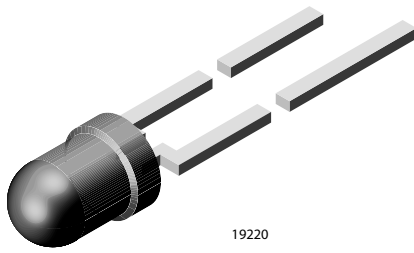

High Efficiency LED in Ø 3 mm Tinted Diffused Package



DESCRIPTION

The TLH.44.. series was developed for standard applications like general indicating and lighting purposes.

It is housed in a 3 mm tinted diffused plastic package. The wide viewing angle of these devices provides a high on-off contrast.

Several selection types with different luminous intensities are offered. All LEDs are categorized in luminous intensity groups. The green and yellow LEDs are categorized additionally in wavelength groups.

That allows users to assemble LEDs with uniform appearance.

FEATURES

- Standard Ø 3 mm (T-1) package
Small mechanical tolerances
Suitable for DC and high peak current
Wide viewing angle
Luminous intensity categorized
Yellow and green color categorized
Material categorization: for definitions of compliance please see www.vishay.com/doc?99912



APPLICATIONS

- Status lights
Off / on indicator
Background illumination
Readout lights
Maintenance lights
Legend light

PRODUCT GROUP AND PACKAGE DATA

- Product group: LED
Package: 3 mm
Product series: standard
Angle of half intensity: ± 30°

Table with 14 columns: PART, COLOR, LUMINOUS INTENSITY (mcd) [MIN., TYP., MAX.], at If (mA), WAVELENGTH (nm) [MIN., TYP., MAX.], at If (mA), FORWARD VOLTAGE (V) [MIN., TYP., MAX.], at If (mA), TECHNOLOGY. Rows include TLHR4400 (Red), TLHO4400 (Soft orange), and TLHY4400 (Yellow).



| PARTS TABLE | | | | | | | | | | | | | | |
|----------------|--------|--------------------------|------|------|------------------------|-----------------|------|------|------------------------|---------------------|------|------|------------------------|--------------|
| PART | COLOR | LUMINOUS INTENSITY (mcd) | | | at I _F (mA) | WAVELENGTH (nm) | | | at I _F (mA) | FORWARD VOLTAGE (V) | | | at I _F (mA) | TECHNOLOGY |
| | | MIN. | TYP. | MAX. | | MIN. | TYP. | MAX. | | MIN. | TYP. | MAX. | | |
| TLHY4401 | Yellow | 2.5 | 10.5 | - | 10 | 581 | - | 594 | 10 | - | 2.4 | 3 | 20 | GaAsP on GaP |
| TLHY4401-AS12Z | Yellow | 2.5 | 10.5 | - | 10 | 581 | - | 594 | 10 | - | 2.4 | 3 | 20 | GaAsP on GaP |
| TLHY4405 | Yellow | 6.3 | 11 | - | 10 | 581 | - | 594 | 10 | - | 2.4 | 3 | 20 | GaAsP on GaP |
| TLHY4405-AS12 | Yellow | 6.3 | 11 | - | 10 | 581 | - | 594 | 10 | - | 2.4 | 3 | 20 | GaAsP on GaP |
| TLHY4405-BT12Z | Yellow | 6.3 | 11 | - | 10 | 581 | - | 594 | 10 | - | 2.4 | 3 | 20 | GaAsP on GaP |
| TLHY4405-MS12 | Yellow | 6.3 | 11 | - | 10 | 581 | - | 594 | 10 | - | 2.4 | 3 | 20 | GaAsP on GaP |
| TLHY4438 | Yellow | 6.3 | - | 20 | 10 | 583 | - | 590 | 10 | - | 2.4 | 3 | 20 | GaAsP on GaP |
| TLHG4400 | Green | 2.5 | 13 | - | 10 | 562 | - | 575 | 10 | - | 2.4 | 3 | 20 | GaP on GaP |
| TLHG4400-MS12 | Green | 2.5 | 13 | - | 10 | 562 | - | 575 | 10 | - | 2.4 | 3 | 20 | GaP on GaP |
| TLHG4401 | Green | 4 | 14 | - | 10 | 562 | - | 575 | 10 | - | 2.4 | 3 | 20 | GaP on GaP |
| TLHG4405 | Green | 6.3 | 15 | - | 10 | 562 | - | 575 | 10 | - | 2.4 | 3 | 20 | GaP on GaP |

| ABSOLUTE MAXIMUM RATINGS (T _{amb} = 25 °C, unless otherwise specified) TLHR440., TLHO440., TLHY440., TLHG440., TLHP440. | | | | |
|---|--------------------------|-------------------|-------------|------|
| PARAMETER | TEST CONDITION | SYMBOL | VALUE | UNIT |
| Reverse voltage | | V _R | 6 | V |
| DC forward current | | I _F | 30 | mA |
| Surge forward current | t _p ≤ 10 μs | I _{FSM} | 1 | A |
| Power dissipation | T _{amb} ≤ 60 °C | P _V | 100 | mW |
| Junction temperature | | T _j | 100 | °C |
| Operating temperature range | | T _{amb} | -40 to +100 | °C |
| Storage temperature range | | T _{stg} | -55 to +100 | °C |
| Soldering temperature | t ≤ 5 s, 2 mm from body | T _{sd} | 260 | °C |
| Thermal resistance junction/ambient | | R _{thJA} | 400 | K/W |

| OPTICAL AND ELECTRICAL CHARACTERISTICS (T _{amb} = 25 °C, unless otherwise specified) TLHR440., RED | | | | | | | |
|--|---------------------------------|----------|----------------|------|------|------|------|
| PARAMETER | TEST CONDITION | PART | SYMBOL | MIN. | TYP. | MAX. | UNIT |
| Luminous intensity ⁽¹⁾ | I _F = 10 mA | TLHR4400 | I _V | 1.6 | 13 | - | mcd |
| | | TLHR4401 | I _V | 2.5 | 14 | - | mcd |
| | | TLHR4405 | I _V | 6.3 | 15 | - | mcd |
| | | TLHR4407 | I _V | 4 | - | 12.5 | mcd |
| Dominant wavelength | I _F = 10 mA | | λ _d | 612 | - | 625 | nm |
| Peak wavelength | I _F = 10 mA | | λ _p | - | 635 | - | nm |
| Angle of half intensity | I _F = 10 mA | | φ | - | ± 30 | - | deg |
| Forward voltage | I _F = 20 mA | | V _F | - | 2 | 3 | V |
| Reverse voltage | I _R = 10 μA | | V _R | 6 | 15 | - | V |
| Junction capacitance | V _R = 0 V, f = 1 MHz | | C _j | - | 50 | - | pF |

Note

⁽¹⁾ In one packing unit I_{Vmin}/I_{Vmax} ≤ 0.5

**OPTICAL AND ELECTRICAL CHARACTERISTICS** ($T_{amb} = 25\text{ }^{\circ}\text{C}$, unless otherwise specified)
TLHO440., SOFT ORANGE

| PARAMETER | TEST CONDITION | PART | SYMBOL | MIN. | TYP. | MAX. | UNIT |
|-----------------------------------|---|----------|-------------|------|----------|------|------|
| Luminous intensity ⁽¹⁾ | $I_F = 10\text{ mA}$ | TLHO4400 | I_V | 1.6 | 13 | - | mcd |
| Dominant wavelength | $I_F = 10\text{ mA}$ | | λ_d | 598 | - | 611 | nm |
| Peak wavelength | $I_F = 10\text{ mA}$ | | λ_p | - | 605 | - | nm |
| Angle of half intensity | $I_F = 10\text{ mA}$ | | ϕ | - | ± 30 | - | deg |
| Forward voltage | $I_F = 20\text{ mA}$ | | V_F | - | 2.4 | 3 | V |
| Reverse voltage | $I_R = 10\text{ }\mu\text{A}$ | | V_R | 6 | 15 | - | V |
| Junction capacitance | $V_R = 0\text{ V}$, $f = 1\text{ MHz}$ | | C_j | - | 15 | - | pF |

Note⁽²⁾ In one packing unit $I_{Vmin.}/I_{Vmax.} \leq 0.5$ **OPTICAL AND ELECTRICAL CHARACTERISTICS** ($T_{amb} = 25\text{ }^{\circ}\text{C}$, unless otherwise specified)
TLHY440., YELLOW

| PARAMETER | TEST CONDITION | PART | SYMBOL | MIN. | TYP. | MAX. | UNIT |
|-----------------------------------|---|----------|-------------|------|----------|------|------|
| Luminous intensity ⁽¹⁾ | $I_F = 10\text{ mA}$ | TLHY4400 | I_V | 1.6 | 10 | - | mcd |
| | | TLHY4401 | I_V | 2.5 | 10.5 | - | mcd |
| | | TLHY4405 | I_V | 6.3 | 11 | - | mcd |
| | | TLHY4438 | I_V | 6.3 | - | 20 | mcd |
| Dominant wavelength | $I_F = 10\text{ mA}$ | TLHY4400 | λ_d | 581 | - | 594 | nm |
| | | TLHY4401 | λ_d | 581 | - | 594 | nm |
| | | TLHY4405 | λ_d | 581 | - | 594 | nm |
| | | TLHY4438 | λ_d | 583 | - | 590 | nm |
| Peak wavelength | $I_F = 10\text{ mA}$ | | λ_p | - | 585 | - | nm |
| Angle of half intensity | $I_F = 10\text{ mA}$ | | ϕ | - | ± 30 | - | deg |
| Forward voltage | $I_F = 20\text{ mA}$ | | V_F | - | 2.4 | 3 | V |
| Reverse voltage | $I_R = 10\text{ }\mu\text{A}$ | | V_R | 6 | 15 | - | V |
| Junction capacitance | $V_R = 0\text{ V}$, $f = 1\text{ MHz}$ | | C_j | - | 50 | - | pF |

Note⁽¹⁾ In one packing unit $I_{Vmin.}/I_{Vmax.} \leq 0.5$ **OPTICAL AND ELECTRICAL CHARACTERISTICS** ($T_{amb} = 25\text{ }^{\circ}\text{C}$, unless otherwise specified)
TLHG440., GREEN

| PARAMETER | TEST CONDITION | PART | SYMBOL | MIN. | TYP. | MAX. | UNIT |
|-----------------------------------|---|----------|-------------|------|----------|------|------|
| Luminous intensity ⁽¹⁾ | $I_F = 10\text{ mA}$ | TLHG4400 | I_V | 2.5 | 13 | - | mcd |
| | | TLHG4401 | I_V | 4 | 14 | - | mcd |
| | | TLHG4405 | I_V | 6.3 | 15 | - | mcd |
| Dominant wavelength | $I_F = 10\text{ mA}$ | | λ_d | 562 | - | 575 | nm |
| Peak wavelength | $I_F = 10\text{ mA}$ | | λ_p | - | 565 | - | nm |
| Angle of half intensity | $I_F = 10\text{ mA}$ | | ϕ | - | ± 30 | - | deg |
| Forward voltage | $I_F = 20\text{ mA}$ | | V_F | - | 2.4 | 3 | V |
| Reverse voltage | $I_R = 10\text{ }\mu\text{A}$ | | V_R | 6 | 15 | - | V |
| Junction capacitance | $V_R = 0\text{ V}$, $f = 1\text{ MHz}$ | | C_j | - | 50 | - | pF |

Note⁽¹⁾ In one packing unit $I_{Vmin.}/I_{Vmax.} \leq 0.5$



| LUMINOUS INTENSITY CLASSIFICATION | | |
|-----------------------------------|-----------------------|------|
| GROUP | LIGHT INTENSITY (mcd) | |
| STANDARD | MIN. | MAX. |
| L | 1 | 2 |
| M | 1.6 | 3.2 |
| N | 2.5 | 5 |
| P | 4 | 8 |
| Q | 6.3 | 12.5 |
| R | 10 | 20 |
| S | 16 | 32 |
| T | 25 | 50 |
| U | 40 | 80 |

Note

- Luminous intensity is tested at a current pulse duration of 25 ms. The above type numbers represent the order groups which include only a few brightness groups. Only one group will be shipped on each bag (there will be no mixing of two groups on each bag). In order to ensure availability, single brightness groups will not be orderable. In a similar manner for colors where wavelength groups are measured and binned, single wavelength groups will be shipped on any one bag. In order to ensure availability, single wavelength groups will not be orderable.

| COLOR CLASSIFICATION | | | | |
|----------------------|----------------------|------|-------|------|
| GROUP | DOM. WAVELENGTH (nm) | | | |
| | YELLOW | | GREEN | |
| | MIN. | MAX. | MIN. | MAX. |
| 0 | - | - | - | - |
| 1 | 581 | 584 | - | - |
| 2 | 583 | 586 | - | - |
| 3 | 585 | 588 | 562 | 565 |
| 4 | 587 | 590 | 564 | 567 |
| 5 | 589 | 592 | 566 | 569 |
| 6 | 591 | 594 | 568 | 571 |
| 7 | - | - | 570 | 573 |
| 8 | - | - | 572 | 575 |

Note

- Wavelengths are tested at a current pulse duration of 25 ms.

TYPICAL CHARACTERISTICS ($T_{amb} = 25\text{ }^{\circ}\text{C}$, unless otherwise specified)

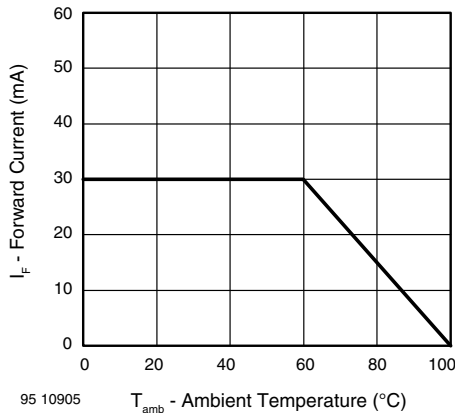

Fig. 1 - Forward Current vs. Ambient Temperature



Fig. 2 - Forward Current vs. Pulse Length

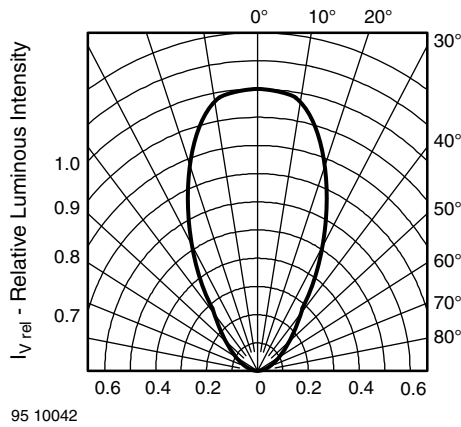

Fig. 3 - Relative Luminous Intensity vs. Angular Displacement

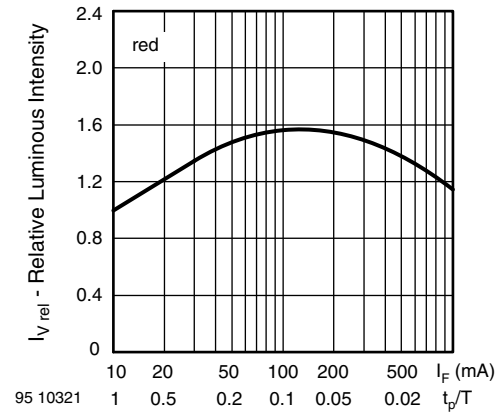

Fig. 6 - Relative Luminous Intensity vs. Forward Current/Duty Cycle



Fig. 4 - Forward Current vs. Forward Voltage

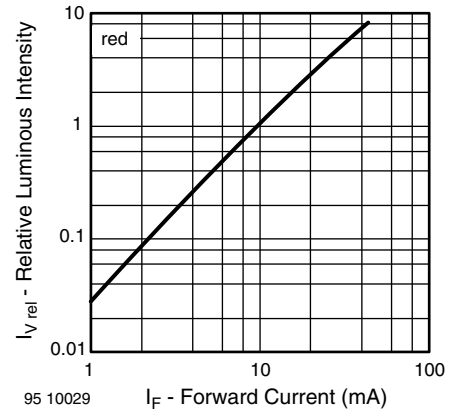

Fig. 7 - Relative Luminous Intensity vs. Forward Current

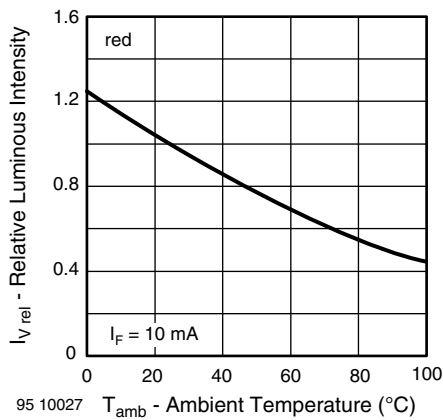

Fig. 5 - Relative Luminous Intensity vs. Ambient Temperature

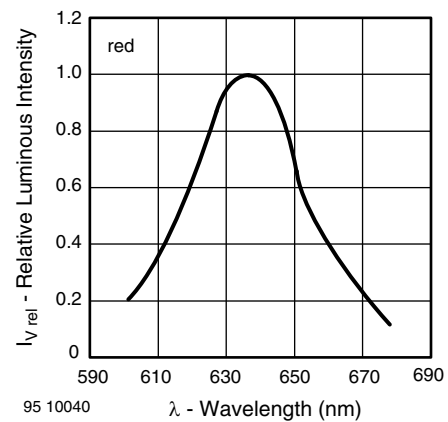

Fig. 8 - Relative Intensity vs. Wavelength

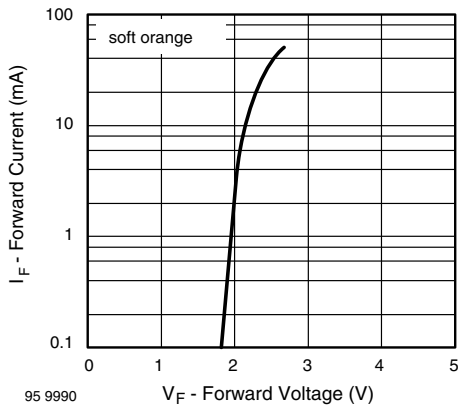

Fig. 9 - Forward Current vs. Forward Voltage

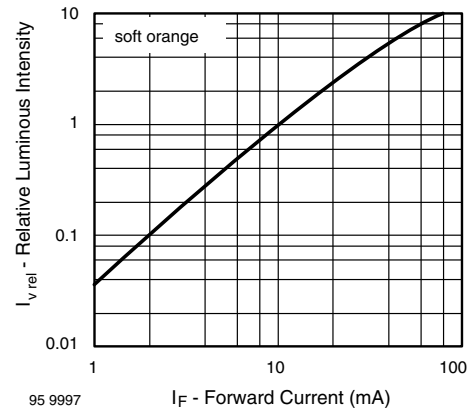

Fig. 12 - Relative Luminous Intensity vs. Forward Current

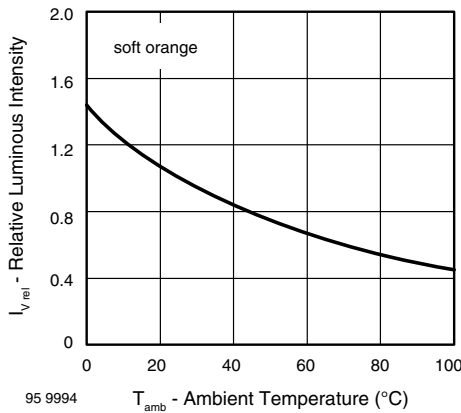

Fig. 10 - Relative Luminous Intensity vs. Ambient Temperature

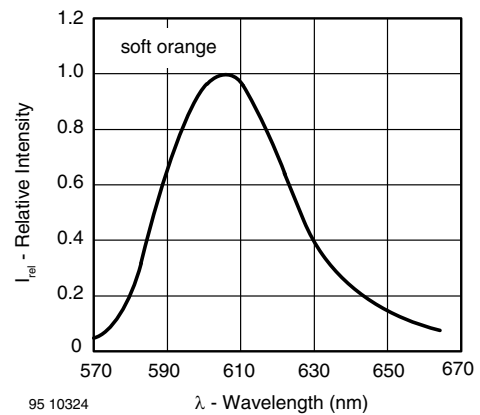

Fig. 13 - Relative Intensity vs. Wavelength



Fig. 11 - Relative Luminous Intensity vs. Forward Current/Duty Cycle



Fig. 14 - Forward Current vs. Forward Voltage

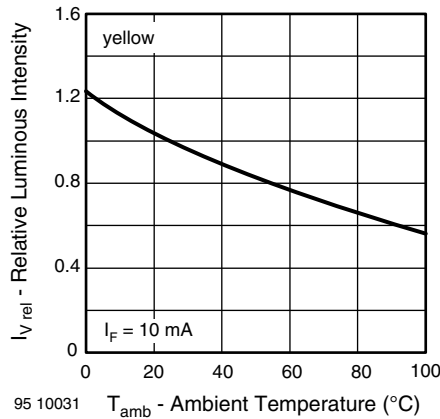

Fig. 15 - Relative Luminous Intensity vs. Ambient Temperature



Fig. 18 - Relative Intensity vs. Wavelength



Fig. 16 - Relative Luminous Intensity vs. Forward Current/Duty Cycle

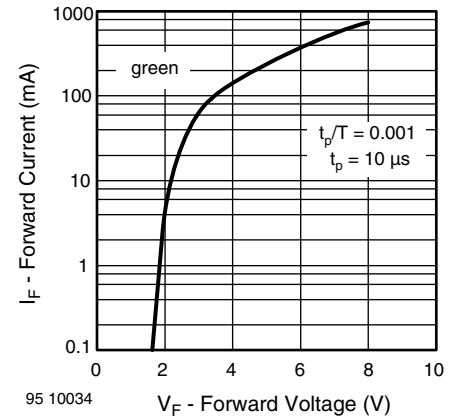

Fig. 19 - Forward Current vs. Forward Voltage

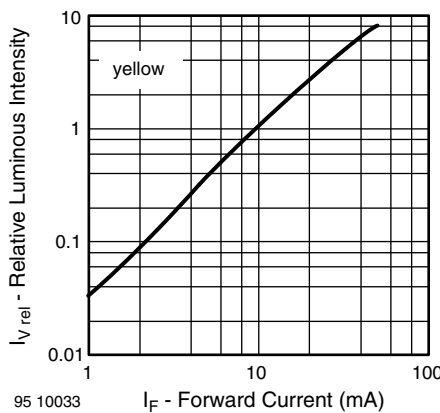

Fig. 17 - Relative Luminous Intensity vs. Forward Current



Fig. 20 - Relative Luminous Intensity vs. Ambient Temperature

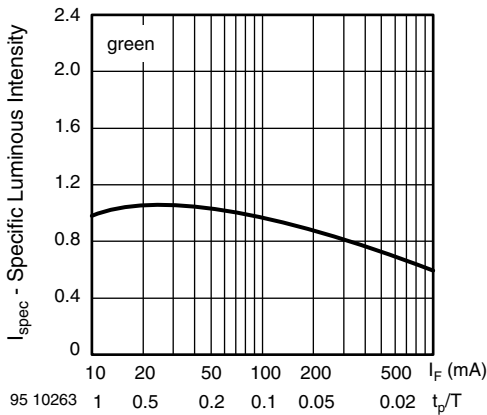

Fig. 21 - Specific Luminous Intensity vs. Forward Current

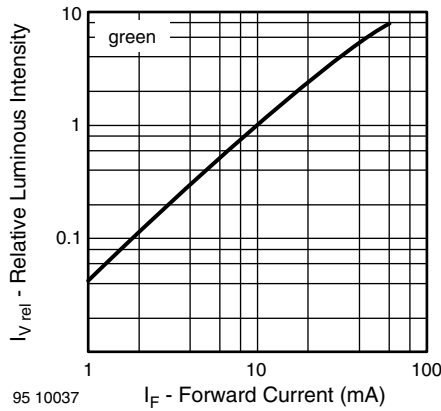

Fig. 22 - Relative Luminous Intensity vs. Forward Current



Fig. 23 - Relative Intensity vs. Wavelength



PACKAGE DIMENSIONS in millimeters

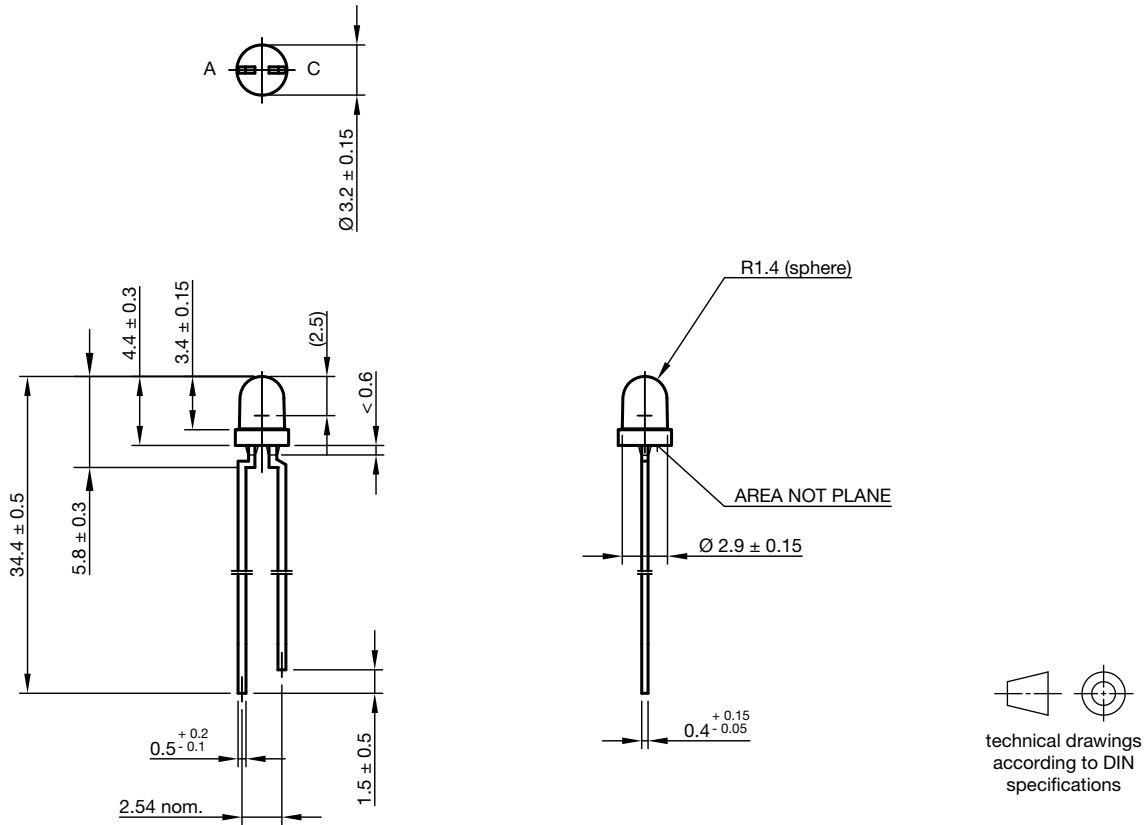

Drawing-No.: 6.544-5255.01-4
Issue: 9; 28.07.14

REEL DIMENSIONS in millimeters

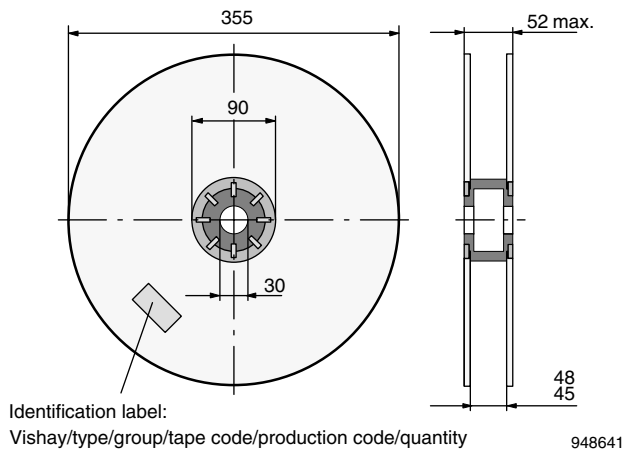

TAPE

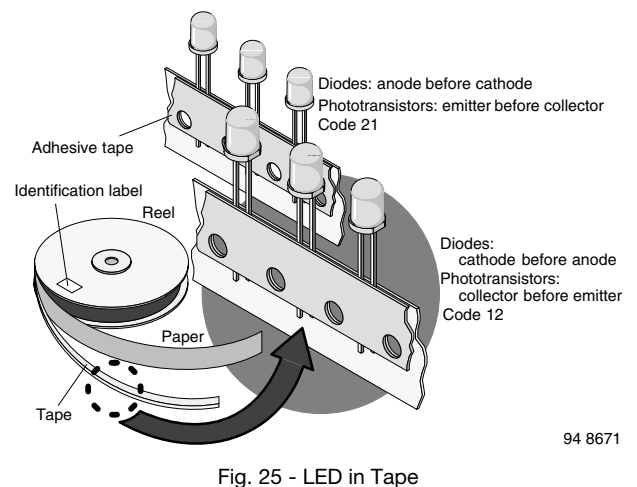



AMMOPACK (ending: Z)

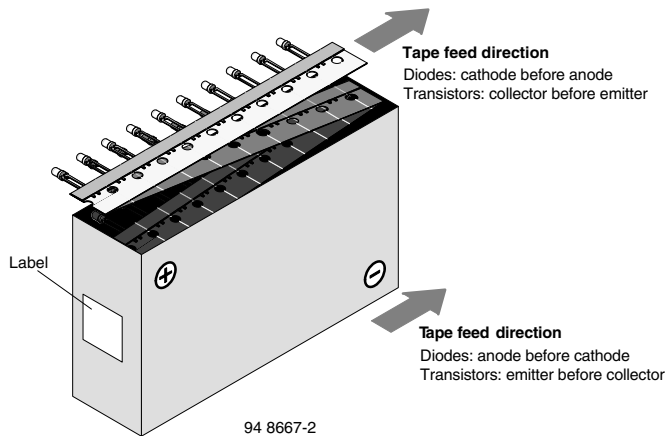
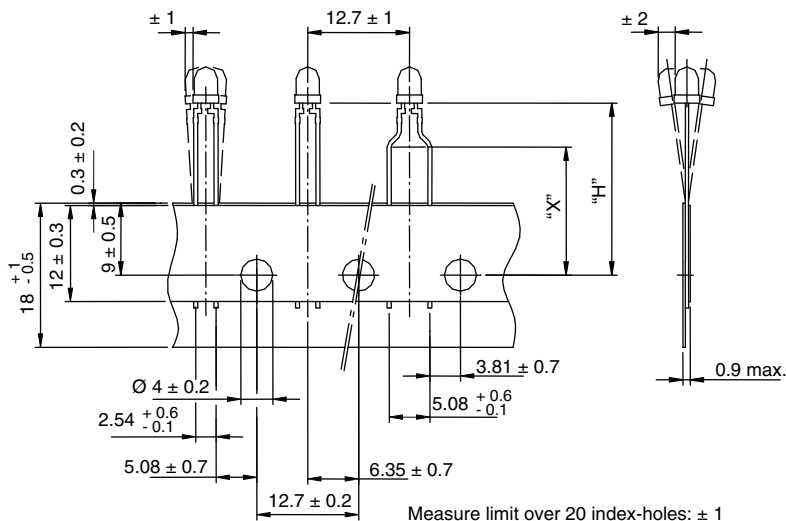

Fig. 26 - Tape Direction

Note

- The new nomenclature for ammpack is e.g. ASZ only, without suffix for the LED orientation. The carton box has to be turned to the desired position: "+" for anode first, or "-" for cathode first. AS12Z and AS21Z are still valid for already existing types, BUT NOT FOR NEW DESIGN.

TAPE DIMENSIONS in millimeters



| | |
|---------------|-------------------------|
| Quantity per: | Reel (Mat.-no. 1764) |
| | 2000 |

21885

| OPTION | DIMENSION "H" ± 0.5 mm | DIMENSION "X" ± 0.5 mm |
|--------|------------------------|------------------------|
| AS | 17.3 | - |
| MS | 25.5 | - |
| CS | 22.0 | - |
| BT | 20.0 | 16.0 |



Disclaimer

ALL PRODUCT, PRODUCT SPECIFICATIONS AND DATA ARE SUBJECT TO CHANGE WITHOUT NOTICE TO IMPROVE RELIABILITY, FUNCTION OR DESIGN OR OTHERWISE.

Vishay Intertechnology, Inc., its affiliates, agents, and employees, and all persons acting on its or their behalf (collectively, "Vishay"), disclaim any and all liability for any errors, inaccuracies or incompleteness contained in any datasheet or in any other disclosure relating to any product.

Vishay makes no warranty, representation or guarantee regarding the suitability of the products for any particular purpose or the continuing production of any product. To the maximum extent permitted by applicable law, Vishay disclaims (i) any and all liability arising out of the application or use of any product, (ii) any and all liability, including without limitation special, consequential or incidental damages, and (iii) any and all implied warranties, including warranties of fitness for particular purpose, non-infringement and merchantability.

Statements regarding the suitability of products for certain types of applications are based on Vishay's knowledge of typical requirements that are often placed on Vishay products in generic applications. Such statements are not binding statements about the suitability of products for a particular application. It is the customer's responsibility to validate that a particular product with the properties described in the product specification is suitable for use in a particular application. Parameters provided in datasheets and / or specifications may vary in different applications and performance may vary over time. All operating parameters, including typical parameters, must be validated for each customer application by the customer's technical experts. Product specifications do not expand or otherwise modify Vishay's terms and conditions of purchase, including but not limited to the warranty expressed therein.

Except as expressly indicated in writing, Vishay products are not designed for use in medical, life-saving, or life-sustaining applications or for any other application in which the failure of the Vishay product could result in personal injury or death. Customers using or selling Vishay products not expressly indicated for use in such applications do so at their own risk. Please contact authorized Vishay personnel to obtain written terms and conditions regarding products designed for such applications.

No license, express or implied, by estoppel or otherwise, to any intellectual property rights is granted by this document or by any conduct of Vishay. Product names and markings noted herein may be trademarks of their respective owners.